

DMP 457

Pressure Transmitter for Shipbuilding and Offshore

Stainless Steel Sensor

accuracy according to IEC 60770:
standard: 0.35 % FSO
option: 0.25 % FSO



Nominal pressure

from 0 ... 100 mbar up to 0 ... 600 bar

Output signals

2-wire: 4 ... 20 mA
others on request

Special characteristics

- ▶ LR-certificate (Lloyd's Register)
- ▶ DNV•GL Type Approval (Det Norske Veritas • Germanischer Lloyd)
- ▶ ABS-certificate (American Bureau of Shipping)
- ▶ CCS-certificate (China Classification Society)
- ▶ flush pressure port
G 1/2" from 100 mbar
- ▶ excellent thermal behaviour





Optional versions

- ▶ IS-version
Ex ia = intrinsically safe for gases and dusts
- ▶ welded pressure port

The pressure transmitter DMP 457 has been especially designed for rough conditions occurring especially in shipbuilding and offshore applications. All gaseous and liquid media, which are compatible with stainless steel 1.4404 (316L) respectively can be used.

Sensor element is a piezoresistive stainless steel sensor with high accuracy and excellent long-term stability. In order to meet the special requirements for shipbuilding and offshore applications extensive tests had to be passed to get the Lloyd's Register (LR), Det Norske Veritas • Germanischer Lloyd (DNV•GL) and China Classification Society (CCS) approvals.

Preferred areas of use are

-  Diesel Engines, Drives
-  Compressors, Pumps
-  Boiler
-  Hydraulic and Pneumatic Control Systems
-  Fuel and Oil



Input pressure range ¹													
Nominal pressure gauge	[bar]	-1 ... 0	0.10	0.16	0.25	0.40	0.60	1	1.6	2.5	4	6	
Nominal pressure abs.	[bar]	-	-	-	-	0.40	0.60	1	1.6	2.5	4	6	
Level gauge / abs.	[mH ₂ O]	-	1	1.6	2.5	4	6	10	16	25	40	60	
Overpressure	[bar]	5	0.5	1	1	2	5	5	10	10	20	40	
Burst pressure ≥	[bar]	7.5	1.5	1.5	1.5	3	7.5	7.5	15	15	25	50	
Nominal pressure gauge	[bar]	10	16	25	40	60	100	160	250	400	600		
Nominal pressure abs.	[bar]	10	16	25	40	60	100	160	250	400	600		
Level gauge / abs.	[mH ₂ O]	100	160	250	400	-	-	-	-	-	-	-	
Overpressure	[bar]	40	80	80	105	210	600	600	1000	1000	1000		
Burst pressure ≥	[bar]	50	120	120	210	420	1000	1000	1250	-	-		
Vacuum resistance		P _N ≥ 1 bar: unlimited vacuum resistance						P _N < 1 bar: on request					

¹ from 60 bar: measurement starts with ambient pressure

Output signal / Supply	
Standard	2-wire: 4 ... 20 mA / V _S = 8 ... 32 V _{DC}
Option IS-protection	2-wire: 4 ... 20 mA / V _S = 10 ... 28 V _{DC}
Performance	
Accuracy ²	Standard: nominal pressure < 0.4 bar: ≤ ± 0.5 % FSO nominal pressure ≥ 0.4 bar: ≤ ± 0.35 % FSO Option: nominal pressure ≥ 0.4 bar: ≤ ± 0.25 % FSO
Permissible load	R _{max} = [(V _S - V _{S min}) / 0.02 A] Ω
Influence effects	supply: 0.05 % FSO / 10 V load: 0.05 % FSO / kΩ
Long term stability	≤ ± 0.1 % FSO / year by reference conditions
Response time	< 10 msec

² accuracy according to IEC 60770 – limit point adjustment (non-linearity, hysteresis, repeatability)

Thermal effects (Offset and Span) / Permissible temperatures				
Nominal pressure P _N	[bar]	-1 ... 0	< 0.4	≥ 0.4
Tolerance band	[% FSO]	≤ ± 0.75	≤ ± 1	≤ ± 0.75
in compensated range	[°C]	-20 ... 85	0 ... 70	-20 ... 85
Permissible temperatures		medium: -40 ... 125°C	electronics / environment: -40 ... 85°C	storage: -40 ... 100°C

Electrical protection	
Short-circuit protection	permanent
Reverse polarity protection	no damage, but also no function
Electromagnetic compatibility	emission and immunity according to - EN 61326 - DNV•GL (Det Norske Veritas • Germanischer Lloyd)

Mechanical stability	
Vibration	4 g (according to DNV•GL: class B, curve 2 / basis: IEC 60068-2-6)

Materials	
Pressure port	stainless steel 1.4404 (316L)
Housing	standard: stainless steel 1.4404 (316L) option field housing: stainless steel 1.4404 (316L), with cable gland
Cable sheath	TPE -U (flame-resistant, halogen free, increased resistance against oil and gasoline, resistant against salt, sea water, heavy oil)
Seals (media wetted)	standard: FKM option: welded version ³ others on request
Diaphragm	stainless steel 1.4435 (316L)
Media wetted parts	pressure port, seals, diaphragm

³ welded version only with pressure ports according to EN 837; possible for nominal pressure ranges P_N ≤ 40 bar

Category of the environment			
Lloyd's Register (LR)	EMV1, EMV2, EMV3, EMV4	number of certificate:	13/20055
Det Norske Veritas • Germanischer Lloyd (DNV•GL)	temperature: D vibration: B humidity: B enclosure: D electromagnetic compatibility: B	number of certificate:	TAA00001GR

Explosion protection	
Approvals DX19-DMP 457	IBExU 10 ATEX 1068 X / IECEx IBE 12.0027X zone 0: II 1G Ex ia IIB T4 Ga zone 20: II 1D Ex ia IIIC T 85°C Da
Safety technical maximum values	U _i = 28 V, I _i = 93 mA, P _i = 660 mW, L _i ≈ 0 μH with field housing: C _i = 105 nF with cable outlet: C _i = 84.7 nF with ISO 4400: C _i = 62.2 nF the supply connections have an inner capacity of max. 90 nF (140 nF with field housing) to the housing
Permissible temperatures for environment	in zone 0: -20 ... 60 °C with p _{atm} 0.8 bar up to 1.1 bar in zone 1 or higher: -20 ... 70 °C
Connecting cables (by factory)	cable capacitance: signal line/shield also signal line/signal line: 160 pF/m cable inductance: signal line/shield also signal line/signal line: 1 μH/m

Miscellaneous	
Current consumption	max. 25 mA
Weight	approx. 140 g (with ISO 4400)
Installation position	any ⁴
Operational life	> 100 x 10 ⁶ pressure cycles
CE-conformity	EMC Directive: 2014/30/EU Pressure Equipment Directive: 2014/68/EU (module A) ⁵
ATEX Directive	2014/34/EU

⁴ Pressure transmitters are calibrated in a vertical position with the pressure connection down. If this position is changed on installation there can be slight deviations in the zero point for pressure ranges $P_N \leq 1$ bar.

⁵ This directive is only valid for devices with maximum permissible overpressure > 200 bar

Wiring diagram

2-wire-system (current)

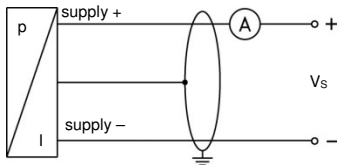

Pin configuration

Electrical connection	ISO 4400	field housing	cable colours (IEC 60757)
Supply +	1	IN +	wh (white)
Supply -	2	IN -	bn (brown)
Shield	ground pin		gnye (green-yellow)

Electrical connections ⁶ (dimensions in mm)

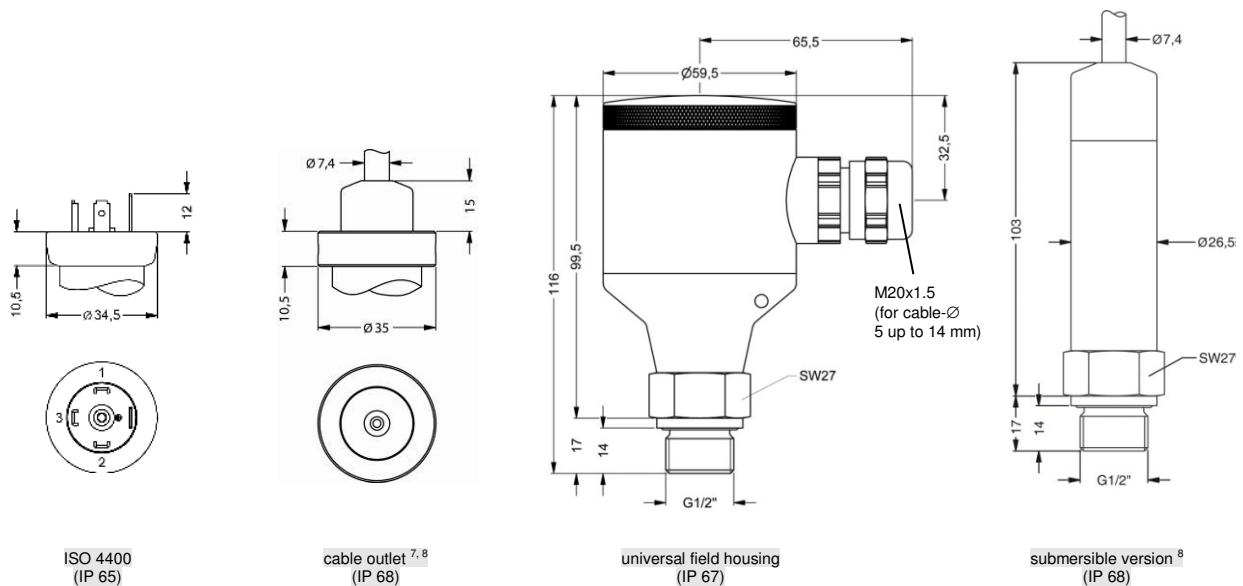

⁶ Generally shielded cable has to be used! Cable versions are delivered with shielded cable. For ISO 4400 the use of shielded cable is compulsory.

⁷ tested at 4 bar or 40 mH₂O for 24 hours

⁸ shielded cable with integrated air tube for atmospheric reference (for nominal pressure ranges absolute, the air tube is closed); different lengths available

Mechanical connection (dimensions in mm)

Standard

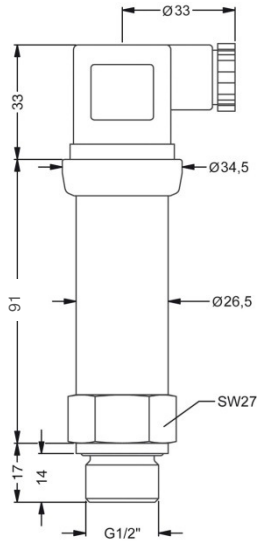

G1/2" DIN 3852

Option

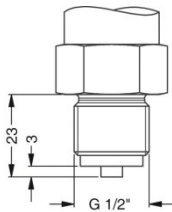

G1/2" EN 837

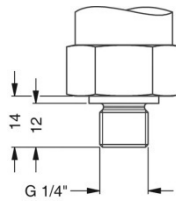

G1/4" DIN 3852

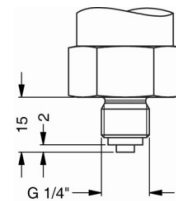

G1/4" EN 837

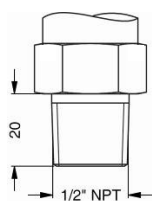

1/2" NPT

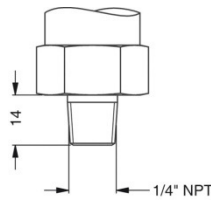

1/4" NPT

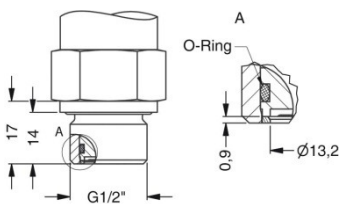

G1/2" flush DIN 3852
(up to 40 bar)

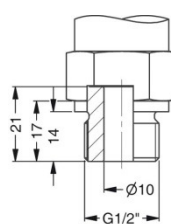

G1/2" open port DIN 3852
(up to 40 bar)

© 2018 BD|SENSORS GmbH – The specifications given in this document represent the state of engineering at the time of publishing. We reserve the right to make modifications to the specifications and materials.

Ordering code DMP 457

DMP 457

□□□□ - □□□□ - □□ - □□ - □□□□ - □□□□ - □□ - □□□□

Pressure		
in bar, gauge	¹	6 0 0
in bar, absolute	²	6 0 1
in mH ₂ O, gauge	¹	6 0 2
in mH ₂ O, absolute	²	6 0 3
Input		
	[mH ₂ O]	[bar]
1	0.1	²
		1 0 0 0
1.6	0.16	²
		1 6 0 0
2.5	0.25	²
		2 5 0 0
4	0.4	
		4 0 0 0
6	0.6	
		6 0 0 0
10	1	
		1 0 0 1
16	1.6	
		1 6 0 1
25	2.5	
		2 5 0 1
40	4	
		4 0 0 1
60	6	
		6 0 0 1
100	10	
		1 0 0 2
160	16	
		1 6 0 2
250	25	
		2 5 0 2
400	40	
		4 0 0 2
	60	
		6 0 0 2
	100	
		1 0 0 3
	160	
		1 6 0 3
	250	
		2 5 0 3
	400	
		4 0 0 3
	600	
		6 0 0 3
-1 ... 0		X 1 0 2
customer		9 9 9 9
Output		
4 ... 20 mA / 2-wire		1
Intrinsic safety 4 ... 20 mA / 2-wire		E
customer		9
Accuracy		
standard for P _N ≥ 0,4 bar	0.35 %	3
standard for P _N < 0,4 bar	0.50 %	5
option for P _N ≥ 0,4 bar	0.25 %	2
customer		9
Electrical connection		
Male and female plug ISO 4400	³	
(for cable Ø 4...6 mm)		G 1 0
Male and female plug ISO 4400 GL	^{3,4}	
(for cable Ø 10...14 mm)		G 0 0
Male and female plug ISO 4400 GL	^{3,4}	
(for cable Ø 4,5...11 mm)		G 0 1
Cable outlet (TPE-U-cable)	⁵	T R 3
Field housing stainless steel		8 8 0
Submersible version (1.4404 / 316L)		T T 3
with TPE-U-cable	⁵	
customer		9 9 9
Mechanical connection		
G1/2" DIN 3852		1 0 0
G1/2" EN 837		2 0 0
G1/4" DIN 3852		3 0 0
G1/4" EN 837		4 0 0
G 1/2" DIN 3852 with	⁶	
flush sensor		F 0 0
G1/2" DIN 3852 open pressure port	⁶	
		H 0 0
1/2" NPT		N 0 0
1/4" NPT		N 4 0
customer		9 9 9
Seals		
FKM		1
without (welded version)	⁷	2
customer		9
Special version		
standard		0 0 0
customer		9 9 9

¹ from 60 bar: measurement starts with ambient pressure
² absolute pressure possible from 0.4 bar
³ Shielded cable has to be used! Cable versions are delivered with shielded cable.
⁴ female plug is GL-approbated
⁵ cable with integrated air tube for atmospheric pressure reference; different lengths deliverable
⁶ possible up to 40 bar
⁷ welded version only with pressure ports according to EN 837; possible with pressure ranges P_N ≤ 40 bar

