



PROPRIETARY ITEM - EXCEPT FOR USES EXPRESSLY GRANTED IN WRITING, INFORMATION DISCLOSED HEREON IS CONFIDENTIAL AND ALL RIGHTS, PATENT AND OTHERWISE ARE RESERVED BY SOUTHCO, INC.

WISE-ACTION™ LATCH-INTERNATIONAL SERIES
ADJUSTABLE GRIP, MIM STAINLESS STEEL

DATE	DRAWN	CHKD	SCALE	DRAWING NUMBER
29MAR2004	AAB	JSS	1:1	J-E3-11-1

NOTES:

- OPERATION: 195° TURN OF DRIVER OR KEY CAUSES PAWL TO ROTATE THEN PULL UP AS SHOWN.
- DETERMINE TOTAL GRIP BY ADDING MAX. OUTER DOOR THICKNESS (INCLUDE ALL ACCESSORIES PLUS COMPRESSED GASKETS AND FRAME THICKNESS.)
- FIND YOUR TOTAL GRIP IN PAWL TABLE TO DETERMINE THE CORRECT PAWL.
- INSTALLATION:
 - INSERT LATCH INTO THE HOLE OF THE DOOR. CHECK FOR PROPER ORIENTATION AND OPERATION OF PAWL.
 - INSTALL LOCKWASHER AND MOUNTING NUT (27mm ACROSS FLATS) ONTO HOUSING. RECOMMENDED TIGHTENING TORQUE FOR MOUNTING NUT IS 20 Nm.
 - INSTALL JAM NUTS, LOCKWASHERS AND PAWL ONTO THE SHAFT. WITH LATCH IN THE CLOSED POSITION, ADJUST JAM NUTS TO POSITION THE PAWL AT THE CORRECT GRIP. TIGHTEN JAM NUTS (20 Nm MAX. TORQUE) USING TWO 17mm WRENCHES.
 - CAUTION: POSITION PAWL SO THAT NO MORE THAN 7.9 Nm TORQUE IS REQUIRED TO CLOSE LATCH.
- THE ASSEMBLY PART NUMBER CONSISTS OF ONE LATCH SUBASSEMBLY AND THE HARDWARE PACKAGED IN ONE BAG OR BOX.
- SEE SHEET 2 FOR DRIVER HEADSTYLES.

ASSEMBLY PART NUMBER (PAWL TYPE)	GRIP RANGE	PAWL POSITION	PAWL OFFSET
E3-VVWW-1Z	11.4 - 27.2	FORWARD	27.4
	66.3 - 76.2	REVERSED	
E3-VVWW-2Z	25.4 - 41.1	FORWARD	13.7
	52.6 - 68.3	REVERSED	
E3-VVWW-3Z	38.9 - 54.6	STRAIGHT	NONE

REV	DATE	DRAWN/CHKD	DESCRIPTION
A	17NOV2004	AAB/MDY	PRN: P2004-1334
B	28FEB2005	AAB/MDY	PRN: P2005-0252
C	14NOV2012	CMS/BGL	PRN: P2012-1549
D	05AUG2014	CMS/KH	PRN: P2014-1487
E	12FEB2016	CMS/LT	PRN: P2016-0117

MILLIMETERS

ALL DIMENSIONS WITHOUT TOLERANCES ARE FOR REFERENCE ONLY.

THIRD ANGLE PROJECTION

B PAPER SIZE

COMPONENT	MATERIAL	FINISH
HOUSING	304/316L STAINLESS STEEL	SEE FINISH TABLE
CAP	304/316L STAINLESS STEEL	SEE FINISH TABLE
RETAINER	302 STAINLESS STEEL	NATURAL
SPRING	302 STAINLESS STEEL	NATURAL
O-RING	BUNA-N	NATURAL
SLEEVE	1075 STEEL	DACROSEALED™
CAM	1076 STEEL	DACROSEALED™
SHAFT	300 SERIES STAINLESS STEEL	PASSIVATED
PIN	1008 STEEL	ZINC PLATE YELLOW CHROMATE
PAWL	304 STAINLESS STEEL	PASSIVATED
M10 LOCKWASHERS (2)	304 STAINLESS STEEL	PASSIVATED
M22 LOCKWASHER	300 SERIES STAINLESS STEEL	PASSIVATED
MOUNTING NUT	STAINLESS STEEL	RESIN IMPREGNATED
FLANGE GASKET	NEOPRENE	NATURAL
JAM NUTS (2)	316 STAINLESS STEEL	PASSIVATED
GASKET SEAL	RUBBER	NATURAL
BUSHING	316 STAINLESS STEEL	PASSIVATED
KEY CAP	303 STAINLESS STEEL	PASSIVATED

ASSEMBLY PART NUMBER

E3 - VV WW - X Z

HOUSING STYLE - DRIVER
GRIP RANGE (PAWL TYPE) - FINISH

HOUSING STYLE - VV

- TYPE A (TURN CLOCKWISE TO LATCH).
- TYPE B (TURN COUNTERCLOCKWISE TO LATCH).

MATERIAL/FINISH - Z

- ELECTROPOLISHED
- HAND BUFFED, ELECTROPOLISHED

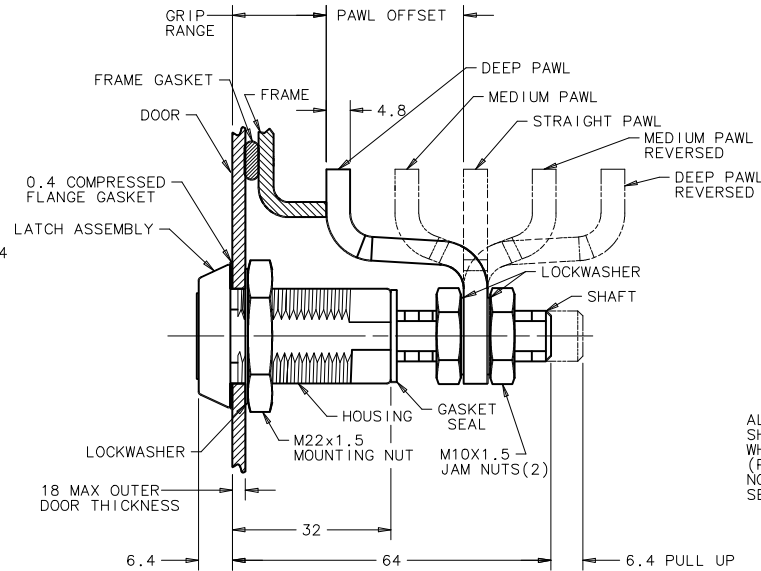
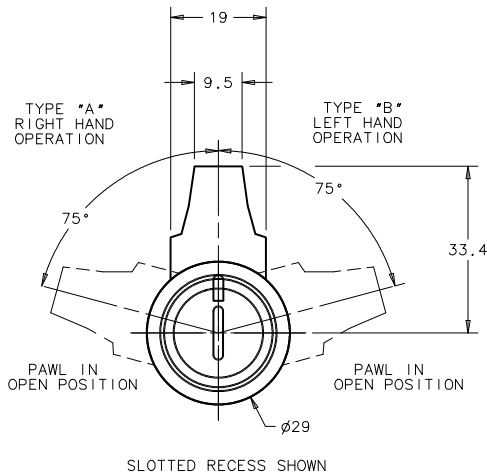

DOOR PREPARATION

METHOD A

METHOD B
(NOT RECOMMENDED FOR GASKETED APPLICATIONS)

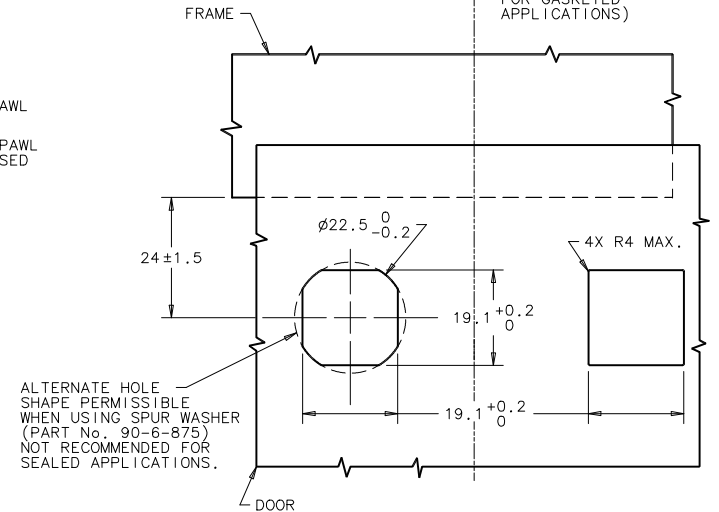

southco

PROPRIETARY ITEM - EXCEPT FOR USES EXPRESSLY GRANTED IN WRITING, INFORMATION DISCLOSED HEREON IS CONFIDENTIAL AND ALL RIGHTS, PATENT AND OTHERWISE ARE RESERVED BY SOUTHCO, INC.

WISE-ACTION™ LATCH-INTERNATIONAL SERIES
ADJUSTABLE GRIP, MIM STAINLESS STEEL

DATE	DRAWN	CHKD	SCALE
29MAR2004	AAB	JSS	1:1

DRAWING NUMBER
J-E3-11-1

ASSEMBLY PART NUMBER (PAWL TYPE)	GRIP RANGE	PAWL POSITION	PAWL OFFSET
E3-VVWW-1Z	11.4 - 27.2	FORWARD	27.4
	66.3 - 76.2	REVERSED	
E3-VVWW-2Z	25.4 - 41.1	FORWARD	13.7
	52.6 - 68.3	REVERSED	
E3-VVWW-3Z	38.9 - 54.6	STRAIGHT	NONE

REV	DATE	DRAWN/CHKD	DESCRIPTION
A	17NOV2004	AAB/MDY	PRN: P2004-1334
B	28FEB2005	AAB/MDY	PRN: P2005-0252
C	14NOV2012	CMS/BGL	PRN: P2012-1549
D	05AUG2014	CMS/KH	PRN: P2014-1487
E	12FEB2016	CMS/LT	PRN: P2016-0117

MILLIMETERS
ALL DIMENSIONS WITHOUT TOLERANCES ARE FOR REFERENCE ONLY.



THIRD ANGLE PROJECTION

B PAPER SIZE

DRIVER

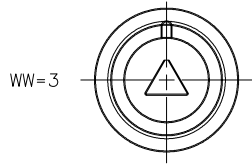

7mm TRIANGLE

DRIVER

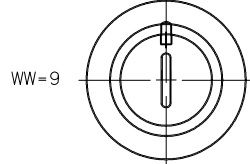

SLOTTED RECESS

DRIVER



TUBULAR KEY

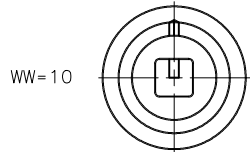

8mm SQUARE

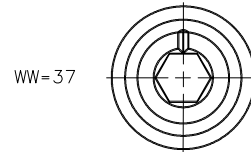

3/8 INCH HEX RECESS

ASSEMBLY PART NUMBER

E3 - VV WW - X Z

HOUSING STYLE
DRIVER
GRIP RANGE (PAWL TYPE)
FINISH

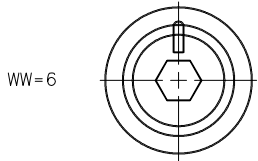

8mm HEX RECESS

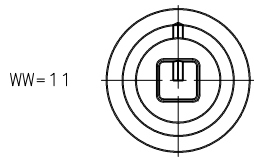

RAILWAY

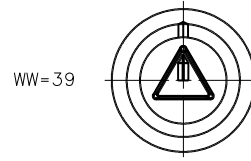

7mm TAPERED TRIANGLE

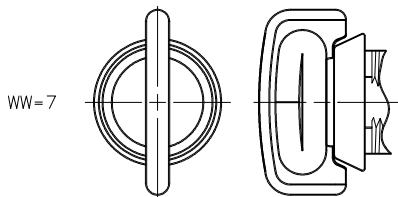

KNOB

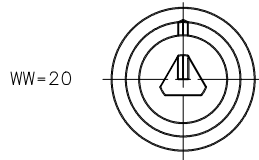

8mm TRIANGLE

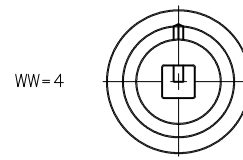

7mm SQUARE