

LMK 458



Probe For Marine And Offshore

Ceramic Sensor

accuracy according to IEC 60770:
standard: 0.25 % FSO
option: 0.1 % FSO

Nominal pressure

from 0 ... 40 cmH₂O up to 0 ... 200 mH₂O

Output signals

2-wire: 4 ... 20 mA
others on request

Special characteristics

- ▶ diameter 39.5 mm
- ▶ LR-certificate (Lloyd's Register)
- ▶ GL-certificate (Germanischer Lloyd)
- ▶ DNV-certificate (Det Norske Veritas)
- ▶ ABS-certificate (American Bureau of Shipping)
- ▶ CCS-certificate (China Classification Society)
- ▶ high overpressure resistance
- ▶ high long-term stability



Optional versions

- ▶ diaphragm Al₂O₃ 99.9 %
- ▶ different housing materials (stainless steel, CuNiFe)
- ▶ IS-version zone 0
- ▶ screw-in and flange version
- ▶ accessories e.g. assembling and probe flange, mounting clamp

The hydrostatic probe LMK 458 has been developed for measuring level in service and storage tanks and is as a consequence certificated for shipbuilding and offshore applications.

A permissible operating temperature of up to 125°C and the possibility to use the device in intrinsic safe areas enable to measure the pressure of various fluids under extreme conditions. The basis for the LMK 458 is a capacitive ceramic sensor element designed by BD|SENSORS, which offers a high overload resistance and medium compatibility.

Preferred areas of use are

-  Water
drinking water abstraction
desalinization plant
- Shipbuilding / Offshore
ballast tanks
-  monitoring of a ship's position and draught
level measurement in ballast and storage tanks

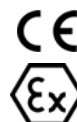

Pressure ranges																
Nominal pressure ¹	[bar]	0.04	0.06	0.1	0.16	0.25	0.4	0.6	1	1.6	2.5	4	6	10	16	20
Level	[mH ₂ O]	0.4	0.6	1	1.6	2.5	4	6	10	16	25	40	60	100	160	200
Overpressure	[bar]	2	2	4	4	6	6	8	8	15	25	25	35	35	45	45
Permissible vacuum	[bar]	-0.2		-0.3		-0.5										-1
¹ available in gauge and absolute; nominal pressure ranges absolute from 1 bar																
Output signal / Supply																
Standard	2-wire: 4 ... 20 mA / V _S = 9 ... 32 V _{DC}								V _{S rated} = 24 V _{DC}							
Option IS-version	2-wire: 4 ... 20 mA / V _S = 14 ... 28 V _{DC}								V _{S rated} = 24 V _{DC}							
Performance																
Accuracy ²	standard: ≤ ± 0.25 % FSO								option: for P _N ≥ 0.6 bar ³ : ≤ ± 0.1 % FSO							
Permissible load	R _{max} = [(V _S - V _{S min}) / 0.02 A] Ω															
Long term stability	≤ ± 0.1 % FSO / year at reference conditions															
Influence effects	supply: 0.05 % FSO / 10 V								permissible load: 0.05 % FSO / kΩ							
Turn-on time	700 msec															
Mean response time	< 200 msec								mean measuring rate 5/sec							
Max. response time	380 msec															
² accuracy according to IEC 60770 – limit point adjustment (non-linearity, hysteresis, repeatability)																
³ Under the influence of disturbance burst according to EN 61000-4-4 (2004) +2 kV accuracy decreased to ≤ ± 0.25 % FSO.																
Thermal effects / Permissible temperatures																
Thermal error	≤ ± 0.1 % FSO / 10 K in compensated range -20 ... 80 °C															
Permissible temperatures	medium / electronics / environment: -25 ... 125 °C								storage: -40 ... 125 °C							
Electrical protection⁴																
Short-circuit protection	permanent															
Reverse polarity protection	no damage, but also no function															
Electromagnetic compatibility	emission and immunity according to - EN 61326 - Germanischer Lloyd (GL) - Det Norske Veritas (DNV)															
⁴ additional external overvoltage protection unit in terminal box KL 1 or KL 2 with atmospheric pressure reference available																
Mechanical stability																
Vibration	4 g (according to GL: curve 2 / according to DNV: Class B / basis: DIN EN 60068-2-6)															
Electrical connection																
Cable outlet	shielded cable with integrated air tube for atmospheric reference (for nominal pressure ranges sealed gauge and absolute, the air tube is plugged)															
Materials																
Housing	standard: stainless steel 1.4404 (316L) option: CuNi10Fe1Mn (resistant against sea water) others on request															
Seals (media wetted)	standard: FKM options: EPDM, FFKM (min. permissible temperature from -15 °C) others on request															
Diaphragm	standard: ceramics Al ₂ O ₃ 96 % option: ceramics Al ₂ O ₃ 99.9 %															
Cable sheath	TPE -U (flame-resistant, halogen free, increased resistance against oil and gasoline, resistant against salt, sea water, heavy oil)															
Miscellaneous																
Optionally cable protection	stainless steel pipe for probe in stainless steel: available as compact product (standard: stainless steel pipe with a total length up to 2 m possible; other lengths on request)															
Ingress protection	IP 68															
Current consumption	max. 21 mA															
Weight	min. 650 g (without cable)															
CE-conformity	EMC Directive: 2014/30/EU															
ATEX Directive	2014/34/EU															
Option Pt 100 temperature element⁵																
Temperature range	-25 ... 125 °C															
Connection temperature element	3-wire															
Resistance	100 Ω at 0 °C															
Temperature coefficient	3850 ppm/K															
Supply I _S	0.3 ... 1.0 mA _{DC}															
Category of the environment																
Lloyd's Register (LR)	EMV1, EMV2, EMV3, EMV4								number of certificate: 13/20055							
Germanischer Lloyd (GL)	D, EMC 1								number of certificate: 60 481 - 09 HH							
Det Norske Veritas (DNV)	temperature: D				humidity: B				vibration: B				number of certificate: A-12144			
electromagnetic compatibility: B																
IS-protection																
Approval DX14A-LMK 458	IBExU 07 ATEX 1180 X								zone 0: II 1G Ex ia IIB T4 Ga							
Safety technical maximum values	U _i = 28 V, I _i = 93 mA, P _i = 660 mW, C _i = 105 nF; L _i = 5 μH; the supply connections have an inner capacity of max. 140 nF opposite the enclosure															
Permissible temp. for environment	in zone 0 ⁶ : -20 ... 60 °C with p _{atm} 0.8 bar up to 1.1 bar zone 1 and higher: -25 ... 70 °C															
Connecting cables (by factory)	cable capacity:				signal line/shield as well as signal line/signal line: 160 pF/m											
	cable inductance:				signal line/shield as well as signal line/signal line: 1 μH/m											
⁵ only for 4...20mA, cable length max. 5m																
⁶ for optional stainless steel pipe the following designation is valid: "II 1 G Ex ia IIC T4" (zone 0)																

Wiring diagrams

2-wire-system (current)

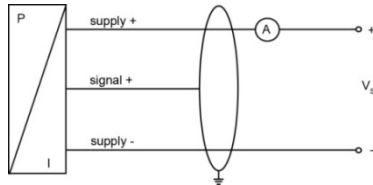

2-wire-system (current) with Pt 100

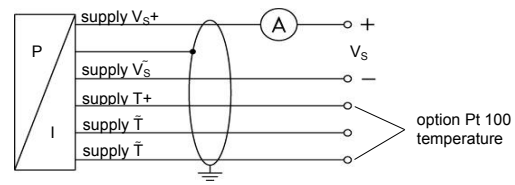

Pin configuration

Electrical connection	cable colours (IEC 60757)
Supply V_S+	wh (white)
Supply V_S-	bn (brown)
Option Pt 100 temperature element:	
Supply T+ (with Pt 100)	ye (yellow)
Supply T- (with Pt 100)	gy (grey)
Supply T- (with Pt 100)	pk (pink)
Shield	gnye (green-yellow)

Dimensions (in mm)

probe versions

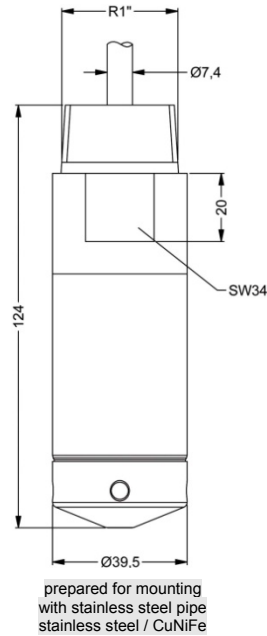
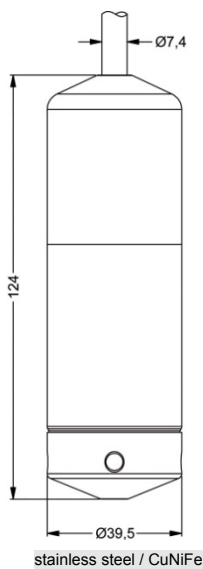

screw-in version

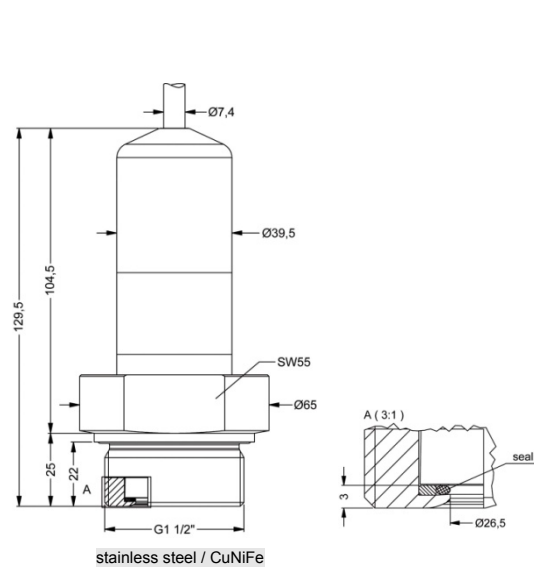

flange version

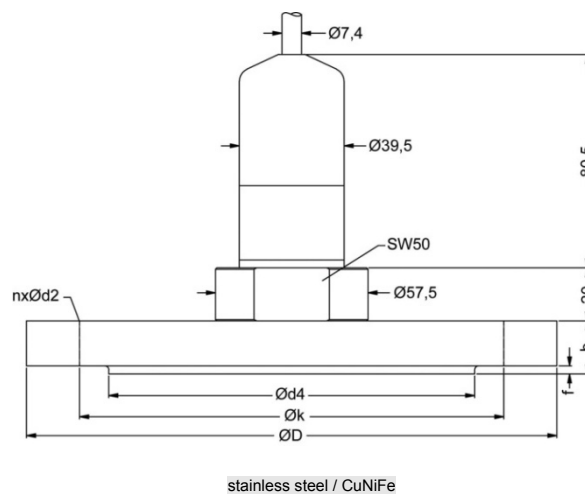

Probe flange for flange version	
Technical Data	
Suitable for	LMK 382, LMK 382H, LMK 458
Flange material	stainless steel 1.4404 (316L)
Hole pattern	according to DIN 2507
Version	Size (in mm)
DN25 / PN40	D = 115, k = 85, d4 = 68, b = 18, f = 2, n = 4, d2 = 14
DN50 / PN40	D = 165, k = 125, d4 = 102, b = 20, f = 3, n = 4, d2 = 18
DN80 / PN16	D = 200, k = 160, d4 = 138, b = 20, f = 3, n = 8, d2 = 18
Ordering type	
Probe flange DN25 / PN40	ZSF2540
Probe flange DN50 / PN40	ZSF5040
Probe flange DN80 / PN16	ZSF8016

Assembling flange with cable gland	
Technical Data	
Suitable for	all probes
Flange material	stainless steel 1.4404 (316L)
Material of cable gland	standard: brass, nickel plated on request: stainless steel 1.4305 (303); plastic
Seal insert	material: TPE (ingress protection IP 68)
Hole pattern	according to DIN 2507
Version	Size (in mm)
DN25 / PN40	D = 115, k = 85, b = 18, n = 4, d = 14
DN50 / PN40	D = 165, k = 125, b = 20, n = 4, d = 18
DN80 / PN16	D = 200, k = 160, b = 20, n = 8, d = 18
Ordering type	
Assembling Flange DN25 / PN40	ZMF2540
Assembling Flange DN50 / PN40	ZMF5040
Assembling Flange DN80 / PN16	ZMF8016

cable gland M16x1.5 with seal insert (for cable-Ø 4 ... 11 mm)

