

<b>VT</b>	<b>Datenblatt</b>	
	<b>Data sheet</b>	

Type **F 680-6-4.1**  
Type **FHE 680-6-4.1**  
Type **FT 680-6-4.1**  
Type **FTHE 680-6-4.1**

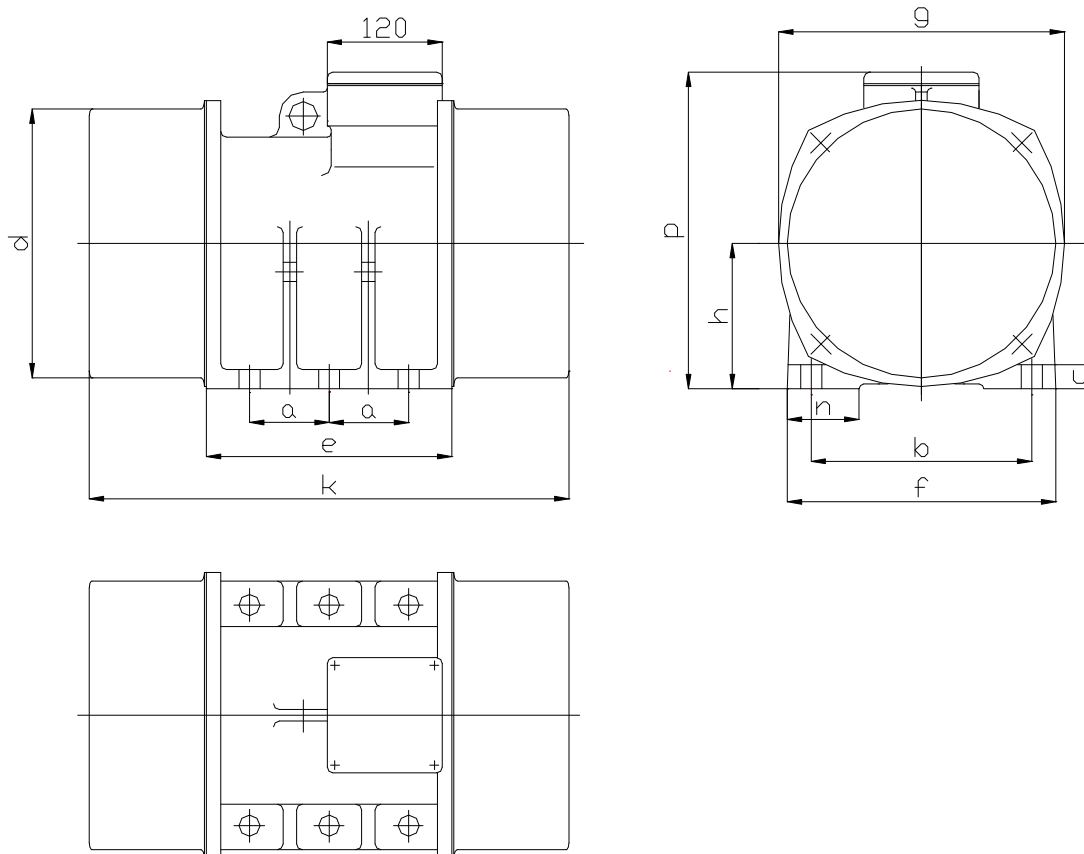

### Maße / Dimensions [ mm ]

a	b	c	d	e	f	g	h	k	n	p
105	248	28	280	300	310	300	160	680	80	344

### Technische Daten / Technical data

Spannung Voltage	Frequenz Frequency	Leistungs- aufnahme Power consumption	Nennstrom Nominal current	Leistungsfaktor Power factor	Anzugsmoment Starting current ratio
[V]	[Hz]	[kW]	[A]	cos φ	$I_A / I_N$
220/380	50	2,70	12,20/7,06	0,60	6,6

Fliehkraft Centrifugal force	Arbeitsmoment Working moment	Befestigungs- Schrauben Hexagon screw	Gewicht weight
[N]	[kgcm]		[kg]
37290	680	6 x M20	168