

SLM20B6

Photoelectric Sensor – Bifurcated Retroreflective Sensor

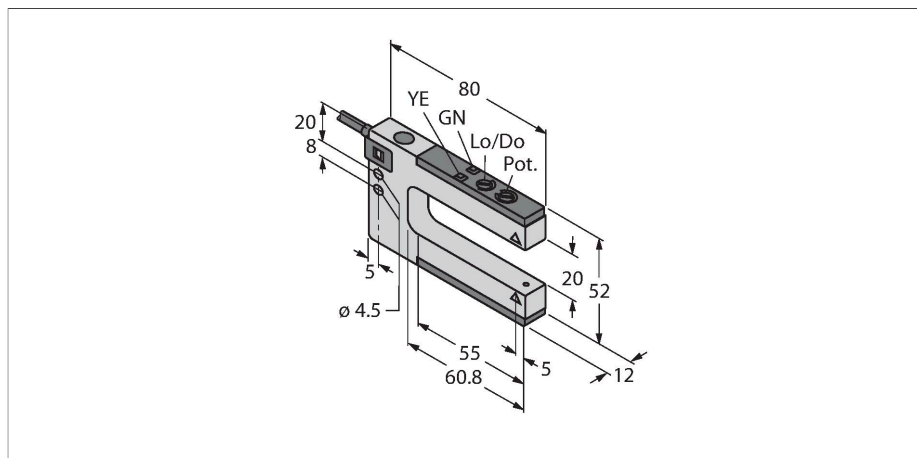

Features

- Cable, PVC, 2 m
- Protection class IP67
- Sensitivity adjusted via potentiometer
- Operating voltage: 10...30 VDC
- Switching output, bipolar, light or dark operation

Wiring diagram

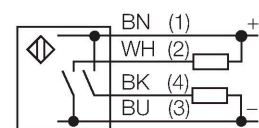

Technical data

Type	SLM20B6
ID	3079217
Optical data	
Function	Slot sensor
Operating mode	Emitter/receiver pair
Light type	Red
Wavelength	680 nm
Range	20 mm
Slot width	20 mm
Electrical data	
Operating voltage	10...30 VDC
Residual ripple	< 10 % U _{ss}
DC rated operational current	≤ 100 mA
No-load current	≤ 25 mA
Short-circuit protection	yes
Reverse polarity protection	yes
Output function	NO contact, PNP/NPN
Switching frequency	≤ 1000 Hz
Readiness delay	≤ 100 ms
Response time typical	< 0.5 ms
Setting option	Potentiometer
Mechanical data	
Design	Fork, SLM20
Dimensions	80 x 12 x 52 mm
Housing material	Metal, Zinc Die-Cast with Nickel-Plating
Lens	plastic, Acrylic
Electrical connection	Cable, 2 m, PVC

Functional principle

Bifurcated retro-reflective sensors and opposed mode sensors - The advantages of two sensor types combined in a single compact housing. Additional alignment of emitter and receiver is no longer required. The slot widths are 10 mm, 30 mm, 50 mm, 80 mm, 120 mm and 220 mm. The sensor features a potentiometer to adjust the sensitivity and a rotary switch to set light or dark switching.

Technical data

Number of cores	4
Core cross-section	0.35 mm ²
Ambient temperature	-20...+60 °C
Relative humidity	0...95 %
Protection class	IP67
Power-on indication	LED, Green
Switching state	LED, Yellow
Error indication	LED
Alarm display	LED yellow Flashing
Tests/approvals	
Approvals	CE