

Accessori Accessories

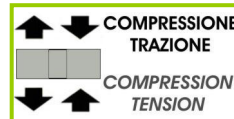

**WIMOD**  
Trasmissione WIRELESS  
WIRELESS transmission

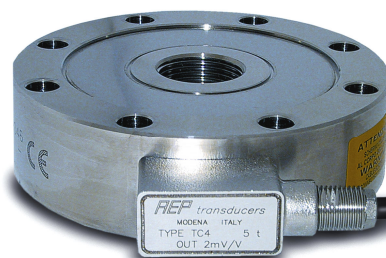

**ACCREDIA**  
CENTRO ITALIANO DI ACCREDITAMENTO

Certificato di Taratura ACCREDIA  
**A RICHIESTA**

LAT N° 093  
**Calibration Centre**  
The products are NOT covered by accreditation

ACCREDIA Calibration Certificate  
**ON REQUEST**

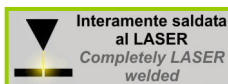

Dimensioni Dimensions

[mm]

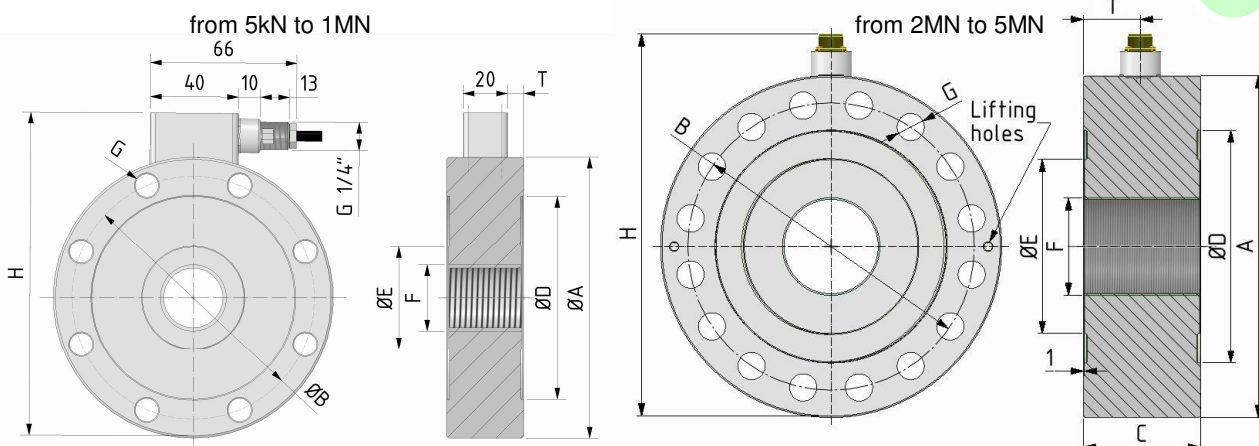

CODE	LOAD	CODE	LOAD	ØA	B	C	ØD	ØE	F	G	n°G	H	T	KHz <sup>(2)</sup>
CTC4100250K5	250 kg	CTC41002KN5I15	2,5 kN	100	86	35	72	32	M20×1.5	9	6	121	7.5	2.5
CTC4100500K5	500 kg	CTC41005KNI15	5 kN											2.5
CTC41001T5	1 t	CTC410010KNI15	10 kN											2.5
CTC41002T55	2.5t	CTC410025KNI15	25 kN											4.8
CTC41005T5	5 t <sup>(3)</sup>	CTC410050KNI15	50 kN <sup>(3)</sup>											8.6
CTC41275T5	5 t	CTC412750KNI15	50 kN	127	110	35	92	47	M30×2	10.5	8	149	7.5	3.8
CTC412710T5	10 t	CTC4127100KNI15	100 kN											5.8
CTC416520T5	20 t	CTC4165200KNI15	200 kN	165	138	50	108	62	M42×3	17	12	188	15	5.7
CTC416530T5	30 t	CTC4165300KNI15	300 kN			7.3								
CTC416550T5	50 t	CTC4165500KNI15	500 kN			20								9.8
CTC423075T5	75 t	CTC4230750KNI15	750 kN	230	185	80	145	98	M60×3	26	12	254	30	3.2
CTC4230100T5	100 t	CTC42301MNI15	1 MN											
<sup>(1)</sup> CTC4300200T5	200 t	<sup>(1)</sup> CTC43002MNI15	2 MN	300	250	100	198	132	M100×3	25	16	339	50	2.7
<sup>(1)</sup> CTC4350300T5	300 t <sup>(4)</sup>	<sup>(1)</sup> CTC43503MNI15	3 MN <sup>(4)</sup>											
<sup>(1)</sup> CTC4350500T5	500 t <sup>(4)</sup>	<sup>(1)</sup> CTC43505MNI15	5 MN <sup>(4)</sup>	350	294	120	238	178	M100×3	28	16	389	60	2.8
						130								

<sup>(1)</sup> La taratura ACCREDIA in TRAZIONE NON può essere eseguita dal Centro LAT N° 093, a richiesta può essere commissionata ad altri centri accreditati.  
ACCREDIA certification in TENSION can NOT be performed by LAT n° 93 Laboratory, on request it can be ordered to other accredited laboratories.

<sup>(2)</sup> Frequenza naturale / Natural frequency

**Dati Tecnici**
**Technical Data**

Classe di precisione: <b>ISO 376</b>		Accuracy class: <b>ISO 376</b>		<b>1</b>				
CARICO NOMINALE	NOMINAL LOAD	2.5 - 5 kN 10 - 25 kN 50 <sup>(3)</sup> kN	50 kN 100 kN	200 kN 300 kN	500 kN	750kN 1 MN	2 MN	3 MN <sup>(4)</sup> 5 MN <sup>(4)</sup>
ERRORI RELATIVI (al valore letto) a) ripetibilità 0°-120°-240° (b) b) interpolazione (fc) c) reversibilità (u) d) zero (fo)	RELATIVE ERRORS (at reading) a) repeatability 0°-120°-240° (b) b) interpolation (fc) c) reversibility (u) d) zero (fo)	$\leq \pm 0.145\%$ <sup>(5)</sup> $\leq \pm 0.090\%$ <sup>(5)</sup> $\leq \pm 0.240\%$ <sup>(5)</sup> $\leq \pm 0.030\%$ F.S.						
LINEARITA' ISTERESI	LINEARITY HYSTERESIS	$\leq \pm 0.05\%$ F.S.						
EFFETTO DELLA TEMPERATURA (10°C) a) sullo zero b) sulla sensibilità EFFETTO CARICO TRASVERSALE: a) al 10% del carico nominale	TEMPERATURE EFFECT (10°C) a) on zero b) on sensitivity EFFECT OF TRANSVERSE LOAD: a) at 10% of nominal load	$\leq \pm 0.028\%$ F.S. $\leq \pm 0.024\%$ F.S. $\leq \pm 0.030\%$ F.S.						
SENSIBILITA' NOMINALE TOLLERANZA DI CALIBRAZIONE	NOMINAL SENSITIVITY SENSIVITY TOLERANCE	2 mV/V <sup>(6)</sup> $\leq \pm 0.1\%$ F.S.						
CARICO NOMINALE RESISTENZA DI INGRESSO RESISTENZA DI USCITA	NOMINAL LOAD INPUT RESISTANCE OUTPUT RESISTANCE	<b>2.5 - 5 - 10 - 25 - 50 - 100 - 200 - 300 - 500 kN</b> 800 ± 20 Ω 705 ± 2 Ω						
CARICO NOMINALE RESISTENZA DI INGRESSO RESISTENZA DI USCITA	NOMINAL LOAD INPUT RESISTANCE OUTPUT RESISTANCE	<b>750 - 1000 - 2000 - 3000 - 5000 kN</b> 430 ± 20 Ω 352 ± 2 Ω						
RESISTENZA DI ISOLAMENTO BILANCIAMENTO DI ZERO ALIMENTAZIONE DI RIFERIMENTO ALIMENTAZIONE NOMINALE ALIMENTAZIONE MAX.	INSULATION RESISTANCE ZERO BALANCE RECOMENDED SUPPLY VOLTAGE NOMINAL SUPPLY VOLTAGE RANGE MAXIMUM SUPPLY VOLTAGE	> 5 GΩ $\leq \pm 1\%$ F.S. 10 V 1-15 V 18 V						
VALORI MECCANICI LIMITE RIFERITI AL CARICO NOMINALE : a) carico di servizio b) carico limite c) carico di rottura d) massimo carico trasversale e) carico dinamico limite	MECHANICAL LIMIT VALUES REFERRED TO NOMINAL LOAD : a) service load b) max permissible load c) breaking load d) max transverse load e) max permissible dynamic load	120 % 150 % > 300 % 100 % 75 % <sup>(7)</sup>						
Freccia max. al carico nominale (mm)	Displacement at nominal load (mm)	~0.06	~0.09	~0.17	~0.17	~0.23	~0.21	~0.21
TEMPERATURA DI RIFERIMENTO CAMPO NOMINALE DI TEMPERATURA TEMPERATURA DI ESERCIZIO TEMPERATURA DI STOCCAGGIO	REFERENCE TEMPERATURE TEMPERATURE NOMINAL RANGE SERVICE TEMPERATURE STORAGE TEMPERATURE	+23 °C -10 / +40 °C -10 / +70 °C -20 / +80 °C						
PESO (kg)	WEIGHT (kg)	~1.6	~2.5	~5.8	~6.8	~16.5	~35	~63
CLASSE DI PROTEZIONE (EN 60529) MATERIALE DINAMOMETRO LUNGHEZZA CAVO	PROTECTION CLASS (EN 60529) EXECUTION MATERIAL CABLE LENGTH	IP67 Acciaio Inox / Stainless Steel 5 m (on request 10 m)						
VITI DI FISSAGGIO: a) diametro b) classe di resistenza c) coppia di serraggio (Nm)	FIXING SCREWS: a) diameter b) resistance class c) tightening torque (Nm)	M8 12.9 40	M10 12.9 70	M16 12.9 368	M16 12.9 368	M24 12.9 460	M24 12.9 460	M27 12.9 1500

(3)  Il trasduttore di forza da **50 kN Ø100** viene garantito in **TRAZIONE** fino a **25 kN**.

*The force transducer 50 kN Ø100 is guaranteed in TENSION up to 25 kN.*

(4)  I trasduttori di forza da **3 MN** e **5 MN** sono garantiti in **TRAZIONE** fino a **2,5 MN**.

*The force transducers 3 MN and 5 MN are guaranteed in TENSION up to 2,5 MN.*

(5) Errori percentuali calcolati al valore letto, min. 1/10 del carico nominale.

*Percentage errors referred to reading, min. 1/10 of nominal load.*

(6) Test e calibrazioni eseguite in **COMPRESSIONE** con il trasduttore montato al supporto e viti di fissaggio correttamente serrate.

*Tests and calibrations performed in COMPRESSION with the transducer mounted on a bearing support with correctly tightened clamping screws.*

(7) Il carico dinamico deve essere applicato al filetto centrale del trasduttore e non sulla corona esterna di fissaggio.

*The dynamic load must be applied to the transducer central thread and not to the external fixing rim.*

A richiesta calibrazioni in kg.

*kg calibration on request.*

A richiesta classificazioni secondo **ASTM E74**.

*Classifications according ASTM E74 on request.*

## Applicazioni Applications

COMPRESIONE COMPRESSION	TRAZIONE TENSION
<b>ATTENZIONE:</b> Verificare che le viti di fissaggio e gli accessori siano correttamente serrati.	<b>WARNING:</b> Check that the fixing screws and the accessories are correctly tightened.
Materiale accessori: da 2.5 a 200 kN da 300 kN a 5 MN	Accessories execution material: from 2.5 to 200 kN from 300 kN to 5 MN
Acciaio inox $R_m \geq 90 \text{ kg/mm}^2$ $R_m \geq 130 \text{ kg/mm}^2$	Stainless Steel $R_m \geq 90 \text{ kg/mm}^2$ $R_m \geq 130 \text{ kg/mm}^2$

### Dimensioni Dimensions

[mm]

TC4:	A	B	C	D	E	F	G	H	L	M
2.5, 5, 10, 25, 50 kN	108	37	35	36	∅ 57	∅ 100	∅ 70	M 20 × 1.5	∅ 32	~ 170
50, 100 kN	108	37	35	36	∅ 76	∅ 127	∅ 100	M 30 × 2	∅ 47	~ 200
200 kN	169	60	50	59	∅ 76	∅ 165	∅ 100	M 42 × 3	∅ 62	~ 224
300 kN	169	60	50	59	∅ 76	∅ 165	∅ 100	M 42 × 3	∅ 62	~ 465
500 kN	179	60	60	59	∅ 76	∅ 165	∅ 100	M 42 × 3	∅ 62	~ 513
750 kN, 1 MN	252	85	80	87	∅ 126	∅ 230	∅ 180	M 60 × 3	∅ 98	/
2 MN	309	85	100	124	∅ 129	∅ 300	∅ 250	M100 × 3	∅ 132	/
3 MN	384	120	120	144	∅ 168	∅ 350	∅ 330	M100 × 3	∅ 178	/
5 MN	394	120	130	144	∅ 168	∅ 350	∅ 330	M100 × 3	∅ 178	/





TC4:	CODE	ACCESSORIES (optional):	ACCESSORI (opzionali):
2.5, 5, 10 kN 25, 50 kN	CTIC22	① Loading head.	Testa di carico.
	CTC425M20	② Spherical loading head M20×1.5.	Testa di carico sferica M20×1.5
	CPBTC4D100	③ Mounting plate ∅ 100 mm.	Piastra base ∅ 100 mm.
	CACCEM20	④ Knuckle joints.	Teste a snodo sferico.
50, 100 kN	CTIC28	① Loading head.	Testa di carico.
	CTC445M30	② Spherical loading head M30×2.	Testa di carico sferica M30×2.
	CPBTC4D127	③ Mounting plate ∅ 127 mm.	Piastra base ∅ 127 mm.
	CACCEM30	④ Knuckle joints.	Teste a snodo sferico.
200, 300, 500 kN	CTIC35	① Loading head.	Testa di carico.
	CTS62M42	② Spherical loading head M42×3 (200-300kN)	Testa di carico sferica M42×3 (200-300kN)
	CTC450M42	② Spherical loading head M42×3 (500kN)	Testa di carico sferica M42×3 (500kN)
	CPBTC4D165	③ Mounting plate ∅ 165 mm.	Piastra base ∅ 165 mm.
	CACCEM42	④ Knuckle joints. (max 200kN)	Teste a snodo sferico. (max 200kN)
	CACCEM4230T	④ Knuckle joints. (max 300kN)	Teste a snodo sferico. (max 300kN)
750 kN, 1 MN	CACCEM4250T	④ Knuckle joints. (max 500kN)	Teste a snodo sferico. (max 500kN)
	CTIC60	① Loading head.	Testa di carico.
	CTS96M60	② Spherical loading head M60×3.	Testa di carico sferica M60×3.
	CPBTC4D230	③ Mounting plate ∅ 230 mm.	Piastra base ∅ 230 mm.
2 MN	CTIC106	① Loading head.	Testa di carico.
	TS160M100	② Spherical loading head M100×3 (2MN)	Testa di carico sferica M100×3 (2MN)
	CPBTC4D300	③ Mounting plate ∅ 300 mm.	Piastra base ∅ 300 mm.
3 MN, 5 MN	CTIC140	① Loading head.	Testa di carico.
	CTS170M100	② Spherical loading head M100×3.	Testa di carico sferica M100×3.
	CPBTC4D350	③ Mounting plate ∅ 350 mm.	Piastra base ∅ 350 mm.

## OPZIONI

Da acquistare separatamente

## OPTIONS

To be purchased separately

	CODE	<sup>(8)</sup> OPZIONE	<sup>(8)</sup> OPTION
	<b>CMIL6MF</b>	Uscita diretta connettore <b>MIL6M</b>	<i>Direct output connector MIL6M</i>
	<b>CMIL6FV5</b>	CONNETTORE <b>MIL6M</b> femmina 6 poli dritto completo di <b>CAVO</b> PVC schermato lunghezza 5 m.	<i>Female 6 poles straight MIL6M CONNECTOR complete PVC CABLE, shielded, length 5 m.</i>
	CODE	<sup>(9)</sup> OPZIONE	<sup>(9)</sup> OPTION
	<b>CONNM12MF</b>	Uscita diretta connettore <b>M12</b>	<i>Direct output connector M12</i>
	<b>CONNM12FV5</b>	CONNETTORE <b>M12x1</b> femmina 5 poli dritto completo di <b>CAVO</b> PVC costampato schermato lunghezza 3 m.	<i>Female 5 poles straight M12x1 CONNECTOR complete PVC molded CABLE, shielded, length 3 m.</i>
	CODE	OPZIONE (2, 3 e 5 MN)	OPTION (2, 3 and 5 MN)
	<b>CMIL7FV5</b>	CONNETTORE <b>MIL7M</b> femmina 7 poli dritto completo di <b>CAVO</b> PVC schermato, 6 fili, lunghezza 5 m.	<i>Female 7 poles straight MIL7M CONNECTOR complete PVC CABLE, shielded, 6 wires, length 5 m.</i>

### Collegamenti Elettrici per trasduttori da 2.5 kN a 1MN

*Electrical connection for transducers from 2.5 kN to 1 MN*

**USCITA STANDARD:** cavo schermato PVC 105°C, Ø 5.2 mm a 4x Ø 0.35mm<sup>2</sup> conduttori stagnati. Schermo collegato al corpo del trasduttore.

**STANDARD OUTPUT:** PVC 105°C shielded cable, Ø 5.2mm with 4x Ø 0.35mm<sup>2</sup> tinned conductors. Shield connected to the body of the transducer.

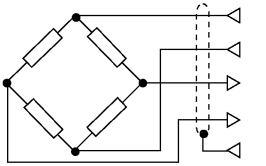
Transducer	OUTPUT	CABLE	CAVO	MIL6M <sup>(8)</sup> (optional)	M12 <sup>(9)</sup> (optional)
	EXCITATION +	Red	Rosso	A	1
	EXCITATION -	Black	Nero	B	3
	OUTPUT +	White	Bianco	D	2
	OUTPUT -	Yellow	Giallo	C	4
	-----	Shield	Schermo	F	5

### Collegamenti Elettrici per trasduttori da 2 MN a 5 MN

*Electrical connection for transducers from 2 MN to 5 MN*

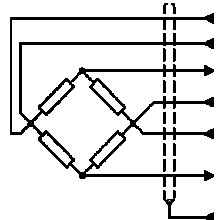
Transducer	OUTPUT	MIL7M	CABLE	CAVO
	EXCITATION +	C	Red	Rosso
	SENSE +	F	Orange	Arancione
	OUTPUT +	A	White	Bianco
	EXCITATION -	B	Black	Nero
	SENSE -	G	Blue	Blu
	OUTPUT -	D	Yellow	Giallo
-----	-----	E	Shield	Schermo

# AEP transducers



Dasa-Rägister  
EN ISO 9001:2008  
IQ-1100-01



LAT N° 093  
Calibration Centre  
The products are NOT  
covered by accreditation



Production Quality  
Assurance Certified n°  
TÜV 06 ATEX 553793 Q

41126 Cognento (MODENA) Italy Via Bottego 33/A Tel:+39-(0)59-346441 Fax:+39-(0)59-346437 E-mail: aep@aep.it

Al fine di migliorare le prestazioni tecniche del prodotto, la società si riserva di apportare variazioni senza preavviso.  
In order to improve the technical performances of the product, the company reserves the right to make any change without notice.