



**Dual Rail LCD KVM Switch  
KL1508Ai / KL1516Ai**

**Full HD Version  
User Manual**



## EMC Information

---

**FEDERAL COMMUNICATIONS COMMISSION INTERFERENCE STATEMENT:** This equipment has been tested and found to comply with the limits for a Class A digital device, pursuant to Part 15 of the FCC Rules. These limits are designed to provide reasonable protection against harmful interference when the equipment is operated in a commercial environment. This equipment generates, uses, and can radiate radio frequency energy and, if not installed and used in accordance with the instruction manual, may cause harmful interference to radio communications. Operation of this equipment in a residential area is likely to cause harmful interference in which case the user will be required to correct the interference at his own expense.

The device complies with Part 15 of the FCC Rules. Operation is subject to the following two conditions: (1) this device may not cause harmful interference, and (2) this device must accept any interference received, including interference that may cause undesired operation.

**FCC Caution:** Any changes or modifications not expressly approved by the party responsible for compliance could void the user's authority to operate this equipment.

**Warning:** Operation of this equipment in a residential environment could cause radio interference.

**Achtung:** Der Gebrauch dieses Geräts in Wohnumgebung kann Funkstörungen verursachen.

**Suggestion:** Shielded twisted pair (STP) cables must be used with the unit to ensure compliance with FCC & CE standards.

### KCC Statement

유선 제품용 / A 급 기기 ( 업무용 방송 통신 기기 )

이 기기는 업무용 (A 급) 전자파적합기기로서 판매자 또는 사용자는 이 점을 주의하시기 바라며, 가정 외의 지역에서 사용하는 것을 목적으로 합니다.

## RoHS

---

This product is RoHS compliant.



## **User Information**

---

### **Online Registration**

Be sure to register your product at our online support center:

---

International	<a href="http://eservice.aten.com">http://eservice.aten.com</a>
---------------	---

---

### **Telephone Support**

For telephone support, call this number:

---

International	886-2-8692-6959
China	86-400-810-0-810
Japan	81-3-5615-5811
Korea	82-2-467-6789
North America	1-888-999-ATEN ext 4988 1-949-428-1111

---

## **User Notice**

All information, documentation, and specifications contained in this manual are subject to change without prior notification by the manufacturer. The manufacturer makes no representations or warranties, either expressed or implied, with respect to the contents hereof and specifically disclaims any warranties as to merchantability or fitness for any particular purpose. Any of the manufacturer's software described in this manual is sold or licensed 'as is'. Should the programs prove defective following their purchase, the buyer (and not the manufacturer, its distributor, or its dealer), assumes the entire cost of all necessary servicing, repair and any incidental or consequential damages resulting from any defect in the software.

The manufacturer of this system is not responsible for any radio and/or TV interference caused by unauthorized modifications to this device. It is the responsibility of the user to correct such interference.

The manufacturer is not responsible for any damage incurred in the operation of this system if the correct operational voltage setting was not selected prior to operation. **PLEASE VERIFY THAT THE VOLTAGE SETTING IS CORRECT BEFORE USE.**

A typical LCD (Liquid Crystal Display) monitor has millions of pixels. A dead pixel refers to a pixel with a defect in its ability to display the correct color output. It most often looks like a tiny black or white spot on your screen, although it can be any other color. Since even a tiny dust particle on one of the pixels during the manufacturing process or a slight bump during shipping can create a dead pixel, the ISO 13406-2 norm defines 4 classes of acceptable screens with dead pixels--Class 1 is the best; Class 4 is the worst. Almost all manufacturers use Class 2 to establish their warranties, which allows a certain amount of dead pixels to exist before they will replace the screen. Since the manufacturers consider these screens to be acceptable under ISO specifications, we cannot be responsible for replacement or warranty of the TFT LCD panel.



## Package Contents

---

### **Basic Package**

The basic KL1508Ai / KL1516Ai package consists of:

- 1 KL1508Ai or KL1516Ai Dual Rail LCD KVM Switch
- 1 Power Cord
- 1 Standard Rack Mount Kit
- 1 Firmware Upgrade Cable
- 1 User Instructions\*

Check to make sure that all of the components are present and in good order. If anything is missing, or was damaged in shipping, contact your dealer.

Read this manual thoroughly and follow the installation and operation procedures carefully to prevent any damage to the switch or to any other devices on the KL1508Ai / KL1516Ai installation.

---

\* Changes may have been made to the manual since it was published. Please visit our Website to check for the most up-to-date version.

---

Copyright © 2020 ATEN® International Co., Ltd.  
Manual Date: 2020-08-19

Altusen and the Altusen logo are registered trademarks of ATEN International Co., Ltd. All rights reserved.  
All other brand names and trademarks are the registered property of their respective owners.

# Contents

---

EMC Information . . . . .	ii
RoHS . . . . .	ii
User Information . . . . .	iii
Online Registration . . . . .	iii
Telephone Support . . . . .	iii
User Notice . . . . .	iv
Package Contents . . . . .	v
Basic Package . . . . .	v
About This Manual . . . . .	xiii
Conventions . . . . .	xv
Product Information . . . . .	xv

## **Chapter 1.**

### **Introduction**

Overview . . . . .	1
Features . . . . .	4
Hardware . . . . .	4
Management . . . . .	5
Easy-to-Use Interface . . . . .	5
Advanced Security . . . . .	6
Virtual Remote Desktop . . . . .	6
Requirements . . . . .	7
General . . . . .	7
External Console . . . . .	7
Computers . . . . .	7
KVM Adapter Cables . . . . .	7
Adapter Cable Resolutions . . . . .	8
Operating Systems . . . . .	9
Components . . . . .	10
Front View . . . . .	10
Keyboard Module . . . . .	11
LCD Module . . . . .	12
Rear View . . . . .	13

## **Chapter 2.**

### **Hardware Setup**

Before You Begin . . . . .	15
Standard Rack Mounting . . . . .	16
Front-L Brackets Mounting . . . . .	18
Optional Rack Mount Kits . . . . .	20
Single Stage Installation . . . . .	21
Daisy Chaining . . . . .	25

## **Chapter 3.**

### **Basic Operation**

Opening the Console . . . . .	27
Opening Separately . . . . .	27
Opening Together . . . . .	29
Operating Precautions . . . . .	30
Closing the Console . . . . .	31
LCD OSD Configuration . . . . .	33
The LCD Buttons . . . . .	33
The Adjustment Settings . . . . .	34
Port Selection . . . . .	35
Manual . . . . .	35
OSD / GUI . . . . .	35
Hotkeys . . . . .	35
Hot Plugging . . . . .	36
Hot Plugging Stations . . . . .	36
Hot Plugging KVM Ports . . . . .	36
Hot Plugging Console Ports . . . . .	36
Powering Off and Restarting . . . . .	37
Port ID Numbering . . . . .	37

## **Chapter 4.**

### **OSD Operation**

OSD Overview . . . . .	39
Manufacturing Number . . . . .	40
OSD Navigation . . . . .	41
OSD Main Screen Headings . . . . .	41
OSD Functions . . . . .	42
F1: GOTO . . . . .	42
F2: LIST . . . . .	43
F3: SET . . . . .	44
F4: ADM . . . . .	47
F5: SKP . . . . .	50
F6: BRC . . . . .	51
F7: SCAN . . . . .	52
F8: LOUT . . . . .	53

## **Chapter 5.**

### **Hotkey Operation**

Hotkey Port Control . . . . .	55
Invoking Hotkey Mode . . . . .	56
Selecting the Active Port . . . . .	57
Auto Scan Mode Switching . . . . .	58
Skip Mode Switching . . . . .	60
Computer Keyboard / Mouse Reset . . . . .	61
Setting the Hotkey Beeper ON/OFF . . . . .	61
Setting the Hotkey key combination . . . . .	62
Setting the OSD Hotkey combination . . . . .	62
Setting the Port Operating System . . . . .	63

Restore the Default Values . . . . .	63
Hotkey Summary Table . . . . .	64

## **Chapter 6.**

### **Keyboard Emulation**

Mac Keyboard . . . . .	65
Sun Keyboard . . . . .	66

## **Chapter 7.**

### **Logging In**

Overview . . . . .	67
Local Login . . . . .	68
Browser Login . . . . .	69
Windows Client AP Login . . . . .	70
The Windows Client AP Connection Screen . . . . .	71
Connecting – Windows Client AP . . . . .	72
Java Client AP Login . . . . .	73
The Java Client AP Connection Screen . . . . .	74
Connecting – Java Client AP . . . . .	75

## **Chapter 8.**

### **The User Interface**

Overview . . . . .	77
The Web Browser Main Page . . . . .	77
Page Components . . . . .	78
The Tab Bar . . . . .	79
The AP GUI Main Page . . . . .	80
The Control Panel . . . . .	81
WinClient Control Panel . . . . .	81
WinClient Control Panel Functions . . . . .	83
Macros . . . . .	86
Video Settings . . . . .	95
The Message Board . . . . .	98
Zoom . . . . .	100
The On-Screen Keyboard . . . . .	101
Mouse Pointer Type . . . . .	103
Mouse DynaSync Mode . . . . .	104
Control Panel Configuration . . . . .	106
The Java Control Panel . . . . .	108

## **Chapter 9.**

### **Port Access**

Overview . . . . .	109
Browser GUI . . . . .	109
AP GUI . . . . .	109
The Sidebar . . . . .	111
The Sidebar Tree Structure . . . . .	111

Scan .....	112
Array Mode .....	112
Filter .....	112
Connections .....	114
Device Level .....	114
Port Level .....	115
Favorites .....	116
User Preferences .....	118
Sessions .....	120
Access .....	121
Browser GUI Interface .....	121
AP GUI Interface .....	123
Saving Changes .....	123
Port Configuration .....	124
Associated Link .....	126
Occupy Timeout .....	127

## **Chapter 10.**

### **User Management**

Overview .....	129
Browser GUI .....	129
AP GUI .....	129
Users .....	130
Adding Users .....	130
Modifying User Accounts .....	134
Deleting User Accounts .....	134
Device Assignment .....	135
Assigning Device Permissions From the User's Notebook .....	135

## **Chapter 11.**

### **Device Management**

KVM Devices .....	137
Device Information .....	137
Operating Mode .....	139
Network .....	140
ANMS .....	144
Security .....	148
Date/Time .....	159

## **Chapter 12.**

### **Log**

Overview .....	161
Browser GUI .....	161
AP GUI .....	161
Log Information .....	162

## **Chapter 13.**

**Maintenance**

Overview . . . . .	163
Browser GUI . . . . .	163
AP GUI . . . . .	163
Device IP Card Firmware Upgrade . . . . .	164
Mainboard and KVM Adapter Cable Firmware Upgrade . . . . .	165
Mainboard Firmware Upgrade . . . . .	165
KVM Adapter Cable Firmware Upgrade . . . . .	166
Station/Adapter Firmware Info . . . . .	167
Recovering from Failed Firmware Upgrade . . . . .	168
Station (mainboard) and Adapter Firmware . . . . .	168
Backup/Restore . . . . .	169
Backup . . . . .	169
Restore . . . . .	170
Ping Host . . . . .	171
System Operation . . . . .	172
Clear Port Names: . . . . .	172
Reset Default Values: . . . . .	172
Apply: . . . . .	172

**Chapter 14.**

**Download**

Overview . . . . .	173
--------------------	-----

**Chapter 15.**

**Port Operation**

Overview . . . . .	175
Connecting to a Port . . . . .	176
The Port Toolbar . . . . .	177
The Toolbar Icons . . . . .	178
Toolbar Hotkey Port Switching . . . . .	179
Recalling the Port Access Page . . . . .	181
GUI Hotkey Summary Table . . . . .	181
Panel Array Mode . . . . .	182
Panel Array Toolbar . . . . .	183
Multuser Operation . . . . .	184

**Chapter 16.**

**The Log Server**

Installation . . . . .	185
Starting Up . . . . .	186
The Menu Bar . . . . .	187
Configure . . . . .	187
Events . . . . .	188
Options . . . . .	190
Help . . . . .	190
The Log Server Main Screen . . . . .	191

Overview . . . . .	191
The List Panel . . . . .	192
The Event Panel . . . . .	192

## Appendix

Safety Instructions . . . . .	193
General . . . . .	193
Rack Mounting . . . . .	195
Technical Support . . . . .	196
International . . . . .	196
North America . . . . .	196
Specifications . . . . .	197
KL1508AiM / KL1508AiN . . . . .	197
KL1516AiM / KL1516AiN . . . . .	200
IP Address Determination . . . . .	203
The Local Console . . . . .	203
IP Installer . . . . .	203
Browser . . . . .	204
IPv6 . . . . .	205
Link Local IPv6 Address . . . . .	205
IPv6 Stateless Autoconfiguration . . . . .	206
Trusted Certificates . . . . .	207
Overview . . . . .	207
Installing the Certificate . . . . .	208
Certificate Trusted . . . . .	209
Self-Signed Private Certificates . . . . .	210
Examples . . . . .	210
Importing the Files . . . . .	210
Troubleshooting . . . . .	211
Administration . . . . .	211
General Operation . . . . .	211
The Windows Client . . . . .	214
The Java Client . . . . .	214
The Log Server . . . . .	215
Panel Array Mode . . . . .	215
Sun Systems . . . . .	216
Screen Resolutions Higher than 1280 x 1024 . . . . .	217
Additional Mouse Synchronization Procedures . . . . .	219
Windows: . . . . .	219
Connection Tables . . . . .	221
KL1508Ai . . . . .	221
KL1516Ai . . . . .	221
Supported Devices . . . . .	222
Clear Login Information . . . . .	223
Dedicated Invocation Keys . . . . .	224
OSD Factory Default Settings . . . . .	225

Limited Warranty . . . . . 226



## About This Manual

---

This User Manual is provided to help you get the most from your KL1508Ai / KL1516Ai system. It covers all aspects of installation, configuration and operation. An overview of the information found in the manual is provided below.

**Chapter 1, Introduction**, introduces you to the KL1508Ai / KL1516Ai System. Its purpose, features and benefits are presented, and its front and back panel components are described.

**Chapter 2, Hardware Setup**, provides step-by-step instructions for setting up your installation, and explains some basic operating procedures.

**Chapter 3, Basic Operation**, explains the fundamental concepts involved in operating the KL1508Ai / KL1516Ai.

**Chapter 4, OSD Operation**, provides a complete description of the KL1508Ai / KL1516Ai's OSD (On Screen Display), and how to work with it.

**Chapter 5, Hotkey Operation**, details all of the concepts and procedures involved in the keyboard hotkey operation of your KL1508Ai / KL1516Ai installation.

**Chapter 6, Keyboard Emulation**, provides tables that list the PC to Mac and PC to Sun keyboard emulation mappings.

**Chapter 7, Logging In**, describes how to log into the KL1508Ai / KL1516Ai via its Graphical User Interface (GUI) with each of the available access methods: from the local console; an internet browser; a standalone Windows application (AP) program; and a standalone Java application (AP) program.

**Chapter 8, The User Interface**, describes the layout and explains the components of the KL1508Ai / KL1516Ai's user interface.

**Chapter 9, Port Access**, describes the Port Access page and how to use it to configure the options it provides regarding port manipulation.

**Chapter 10, User Management**, shows administrators how to create, modify, and delete users, and assign attributes to them.

**Chapter 11, Device Management**, shows administrators how to configure and control overall KL1508Ai / KL1516Ai operations.

**Chapter 12, Log**, shows how to use the log file utility to view all the events that take place on the KL1508Ai / KL1516Ai.

**Chapter 13, Maintenance**, explains how to upgrade the KL1508Ai / KL1516Ai's firmware, as well as the firmware of the KVM Adapter Cables used to connect its ports to the installed devices.

**Chapter 14, Download**, describes how to download standalone AP versions of the Win Client, the Java Client, the Log Server, and Power Over the Net (PON) programs.

**Chapter 15, Port Operation**, provides detailed information on accessing and operating the devices connected to the KL1508Ai / KL1516Ai's ports.

**Chapter 16, The Log Server**, explains how to install and configure the Log Server.

**An Appendix** at the end of the manual provides technical and troubleshooting information.

## Conventions

This manual uses the following conventions:

- Monospaced      Indicates text that you should key in.
- [ ]                Indicates keys you should press. For example, [Enter] means to press the **Enter** key. If keys need to be chorded, they appear together in the same bracket with a plus sign between them: [Ctrl+Alt].
- 1.                 Numbered lists represent procedures with sequential steps.
- ◆                 Bullet lists provide information, but do not involve sequential steps.
- Indicates selecting the option (on a menu or dialog box, for example), that comes next. For example, Start → Run means to open the *Start* menu, and then select *Run*.
-                 Indicates critical information.

## Product Information

For information about all ALTUSEN products and how they can help you connect without limits, visit ALTUSEN on the Web or contact an ALTUSEN Authorized Reseller. Visit ALTUSEN on the Web for a list of locations and telephone numbers:

International	<a href="http://www.aten.com">http://www.aten.com</a>
North America	<a href="http://www.aten-usa.com">http://www.aten-usa.com</a>

This Page Intentionally Left Blank

# Chapter 1

## Introduction

### Overview

---

The KL1508Ai and KL1516Ai Dual Rail LCD KVM Switches are control units that allow secure access to multiple computers from a single KVM (keyboard, video, and mouse) console. A single KL1508Ai or KL1516Ai can control up to 8 or 16 computers, respectively. They consist of an integrated LED-backlit LCD monitor, keyboard, and touchpad in a 1U rack-mountable retractable sliding housing.

The similarities and differences among the models in the KL1508Ai / KL1516Ai series are shown in the following table:

Model	LCD Panel	Ports
KL1508AiM	17"	8
KL1508AiN	19"	8
KL1516AiM	17"	16
KL1516AiN	19"	16

The LCD and keyboard/touchpad modules slide independently of each other. To maximize space in your data center, the keyboard/touchpad module slides back to "hide away" when not in use, while the thin profile LCD monitor rotates back – flush against the rack – allowing convenient monitoring of computer activity.

The KL1508Ai / KL1516Ai features IP-based connectivity that allows one local operator and multiple remote operators to concurrently monitor and access the computers on your installation. Because it uses TCP/IP for its communications protocol, the KL1508Ai / KL1516Ai can be accessed from any computer on the LAN, WAN, or Internet – whether that computer is located down the hall, down the street, or halfway around the world.

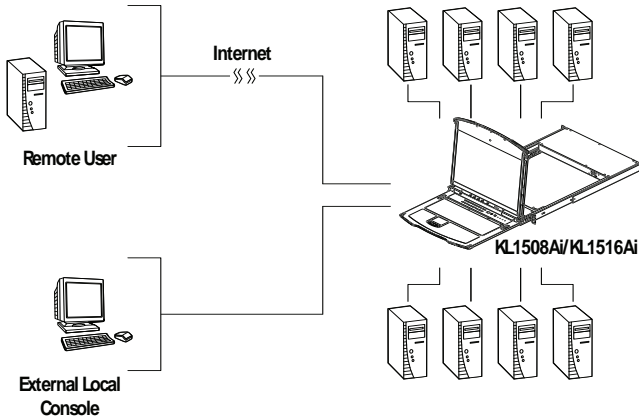

By daisy chaining up to 15 additional switches, as many as 256 computers can be controlled from the original KVM console. An auto-sensing function recognizes the position of each station on the chain, eliminating the need to manually set the position, and a two digit seven-segment LED display on the keyboard module showing each station's position for easy identification.

Compact, high-density, RJ-45 connectors and CAT 5e/6 cable make for a compact, efficient, wiring configuration, while the use of PS/2 and USB *KVM Adapter Cables* to link to the computers, permits any combination of Windows, Macs, Sun computers, and serial devices to coexist on the installation.

For added convenience, ports for an external keyboard, monitor, and mouse are provided on the rear panel – permitting you to manage the switch from an external local console. There is also an external USB mouse port on the keyboard module, allowing you to use an external mouse, rather than the touchpad.

Access to any computer connected to the installation from the local console is easily accomplished by means of a powerful mouse driven graphical OSD (On Screen Display) menu system. A convenient *Auto Scan* feature also permits automatic scanning and monitoring of the activities of all computers running on the installation one by one.

Remote operators connect to the KL1508Ai / KL1516Ai via its IP address from anywhere on the LAN, WAN, or Internet via their browsers. Once they successfully log in, they can take control using either the *Windows Client* or *Java Client* utility. Inclusion of a Java-based client ensures that the KL1508Ai / KL1516Ai is platform independent, and is able to work with most operating systems.

System administrators can handle a multitude of maintenance tasks smoothly and efficiently – from installing and running GUI applications, to BIOS level troubleshooting, routine monitoring, concurrent maintenance, system administration, rebooting and even pre-booting functions – all from a remote connection.

Remote operators can exchange keyboard, video and mouse signals with the computers attached to the KL1508Ai / KL1516Ai just as if they were present locally and working on the equipment directly.

Enhanced features include a *Panel Array Mode* that displays the video output of up to 8 (KL1508Ai) or 16 (KL1516Ai) computers at the same time, and a *Message Board* that allows logged in users to conveniently and instantly communicate with one other – no matter where in the world they actually are.

The unit can be integrated into ATEN's CC2000 Management Software. CC2000 puts administrators in complete control of remote data centers and branch offices no matter where they are in the world – allowing them to remotely monitor and control all devices on a network. Refer to ATEN's website to get more information on CC2000.

Setup is fast and easy - plugging cables into their appropriate ports is all that is entailed. Because the KL1508Ai / KL1516Ai intercepts keyboard input directly, there is no need to get involved in complex installation routines or to be concerned with incompatibility problems.

Since the KL1508Ai / KL1516Ai's firmware is upgradable over the Internet, you can stay current with the latest functionality improvements simply by downloading firmware updates from our website as they become available.

With its advanced security features, the KL1508Ai / KL1516Ai is the fastest, most reliable, most cost effective way to remotely access and manage widely distributed multiple computer installations.

## Features

---

### Hardware

- ◆ Integrated KVM console with 17” or 19” LED-backlit LCD monitor in a Dual Rail housing
- ◆ Exclusive LED illumination light – designed by ATEN to illuminate the keyboard and touchpad to allow visibility in low-light conditions
- ◆ A single console controls up to 8 (KL1508Ai) or 16 (KL1516Ai) computers
- ◆ Daisy chain up to 15 additional KVM switches to control up to 256 computers\*
- ◆ One bus for remote KVM over IP access
- ◆ Space-saving RJ-45 connectors and Cat 5e/6 cabling
- ◆ KVM adapter cables designed with auto conversion to allow interface combinations (PS/2, USB, Sun and serial) to control all computer types
- ◆ Superior Video Quality – supports input video resolutions up to 1920 x 1200 @ 60 Hz\*\* up to 30 meters, 1600 x 1200 @ 60 Hz up to 40 meters, and 1280 x 1024 @ 75 Hz up to 50 meters
- ◆ Extra console ports – manage computers on the LCD KVM switch from an external console (monitor, USB or PS/2 keyboard, and USB or PS/2 mouse)
- ◆ Multiplatform support: PC, Mac, Sun and Serial
- ◆ Supports external USB mouse
- ◆ Dual Rail housing is slightly less than 1U with top and bottom clearance for smooth operation in 1U of rack space
- ◆ Dual Rail – LCD monitor slides independently of the keyboard/touchpad
- ◆ LCD module rotates up to 120 degrees for a comfortable viewing angle
- ◆ Console lock – enables the console drawer to remain securely locked away in position when not in use
- ◆ LCD power button helps save energy and prolong displays’ life
- ◆ Optional rack mount kits available, including easy installation options

---

**Note:**◆ Compatible KVM switches: KH1508A/KH1516A, KH0116, ACS1208A/ACS1216A, CS1708A/CS1716A, and KH1508/KH1516.

---



- ◆ With KVM Adapter Cable KA71xx or KA75xx series; please check the product label to ensure it's the FHD version.
- 

## **Management**

- ◆ Supports 64 user accounts and up to 32 users can be logged in at the same time for control and management
- ◆ End session feature – administrators can terminate any running session
- ◆ Adapter ID – stores port information allowing administrators to relocate servers to different ports, without having to reconfigure the adapters and switch
- ◆ Port Share Mode allows multiple users to gain access to a server simultaneously
- ◆ Remote power control for attached Power Over the NET™ devices
- ◆ Supports integration into ATEN CC2000 Centralized Management Software
- ◆ Event logging and Windows-based Log Server support
- ◆ Local Log Event
- ◆ Firmware upgradeable
- ◆ IPv6 capable

## **Easy-to-Use Interface**

- ◆ Easy computer selection via pushbuttons, Hotkey Mode, OSD (On-Screen Display), and Browser-based GUI
- ◆ Local Console, Browser, and AP GUIs offer a unified multi language interface to minimize user training time and increase productivity
- ◆ Multiplatform client support (Windows, Mac OS X, Linux, Sun)
- ◆ Multi-browser support: Internet Explorer, Chrome, Firefox, Safari, Opera, Mozilla, Netscape
- ◆ Browser-based UI in pure Web technology allows administrators to perform administrative tasks without the need for Java to be pre-installed
- ◆ Panel Array Mode™
- ◆ Keyboard broadcast\* – keyboard input can be duplicated on all the attached servers

- ◆ Keyboard Language support: English (US); English (UK); German; German (Swiss); French; Spanish; Traditional Chinese; Japanese; Korean; Swedish; Italian; Russian; Hungarian and Greek

---

**Note:** Local Console only

---

## **Advanced Security**

- ◆ Remote authentication support: RADIUS, LDAP, LDAPS, and MS Active Directory
- ◆ Supports TLS 1.2 data encryption and RSA 2048-bit certificates to secure user log ins from a browser
- ◆ Flexible encryption design allows users to choose any combination of DES, 3DES, AES, RC4, or Random for independent keyboard/mouse and video data encryption
- ◆ IP/MAC Filter support for enhanced security protection
- ◆ Configurable user and group permissions for server access and control

## **Virtual Remote Desktop**

- ◆ Video quality and video tolerance can be adjusted to optimize data transfer speed; monochrome color depth setting, threshold and noise settings for compression of the data bandwidth in low bandwidth situations
- ◆ Full-screen or sizable and scalable Virtual Remote Desktop
- ◆ Message board feature allows logged in users to communicate with each other
- ◆ Mouse DynaSync™ – automatically synchronizes the local and remote mouse movements
- ◆ On-screen keyboard with multi language support
- ◆ BIOS-level access

## Requirements

---

### General

- ◆ We recommend computers with at least a P 4 2GHz processor, and 1 GB RAM.
- ◆ Browsers must support TLS 1.2 encryption.
- ◆ A network transfer speed of at least 512kbps is recommended.
- ◆ For the *Log Server*, you must have the Microsoft Jet OLEDB 4.0 or higher driver installed.

### External Console

- ◆ A VGA, SVGA, or Multisync monitor capable of the highest resolution that you will be using on any computer in the installation.
- ◆ A USB or PS/2 style mouse
- ◆ A USB or PS/2 style keyboard

### Computers

The following equipment must be installed on the computers that connect to the KL1508Ai or KL1516Ai's KVM ports:

- ◆ A VGA, SVGA or Multisync port
- ◆ A Type A USB port and USB host controller (for USB KVM Adapter Cable Connection, see below)
- ◆ 6-pin mini-DIN keyboard and mouse ports (for PS/2 KVM Adapter Cable Connection, see below)

---

**Note:** The integrated LCD monitor's maximum screen resolution is 1280 x 1024 @ 75 Hz. If you want to use a higher setting for the screen resolutions of the attached computers, see *Screen Resolutions Higher than 1280 x 1024*, page 217.

---

### KVM Adapter Cables

- ◆ Cat 5e/6 cable is required to connect the KL1508Ai / KL1516Ai to one of the KVM adapter cables.

- ♦ The following KVM adapter cables are required for use with the KL1508Ai / KL1516Ai:

Function	Module
Connect to devices with PS/2 ports	KA7920 / KA7520 / KA7120 KA9520 / KA9120
Connect to devices with USB ports	KA7970 / KA7570 / KA7166 / KA7168 / KA7169 / KA7170 KA9570 / KA9170
Connect to Sun Legacy systems (with 13W3 port)	KA9130 / KA7130
Connect to Sun USB systems	KA9170 / KA7170
Connect to serial based devices	KA9140

- Note:** 1. KVM adapter cables are referred to as *I/O Modules* in some dialog boxes.
2. The following cable models support the Adapter Cable ID function:  
KA7920 / KA7970 / KA7520 / KA7570 / KA7120 / KA7130 / KA7166  
/ KA7168 / KA7169 / KA7170.

## **Adapter Cable Resolutions**

The table below provides the maximum resolutions available for each KVM adapter cable.

Model No.	Computer Ports	Video Resolution
KA71xx	KA7120	2 x PS/2, 1 x HDB-15
	KA7130	1 x Min Din 8 Male
	KA7166	2 x USB Type A, 1 x DVI-D
	KA7168	2 x USB Type A, 1 x HDMI
	KA7169	2 x USB Type A, 1 x DisplayPort
	KA7170	1 x USB Type A, 1 x HDB-15
KA75xx	KA7520	2 x PS/2, 1 x HDB-15
	KA7570	1 x USB, 1 x HDB-15
KA79xx	KA7920	2 x PS/2, 1 x HDB-15
	KA7970	1 x USB, 1 x HDB-15
KA91xx	KA9140	N/A

## **Operating Systems**

Supported operating systems are shown in the table below:

<b>OS</b>		<b>Version</b>
Windows		NT <sup>1</sup> , Server 2003, Server 2008, 2000 or later
Linux <sup>2</sup>	RedHat	9.0, Fedora or later, RHEL AS 4, RHEL 5
	SuSE	10 or later, OpenSUSE 10.2; SLES 10 SP1
	Debian	3.1, 4.0
	Ubuntu	7.04, 7.10
UNIX	IBM	AIX4.3, 5L (V5.2,V5.3), V6 (V6.1)
	FreeBSD	5.5, 6.1, 6.2
Novell	Netware	5.0 or later
Sun		Solaris 8, 9, 10
Mac		9.0, 9.1, 10.1, 10.2, 10.3, 10.4 , 10.5
DOS		6.2 or later <sup>1</sup>

<sup>1</sup> Does not support USB. <sup>2</sup> Kernels below 2.6 do not support USB 2.0

# Components

## Front View

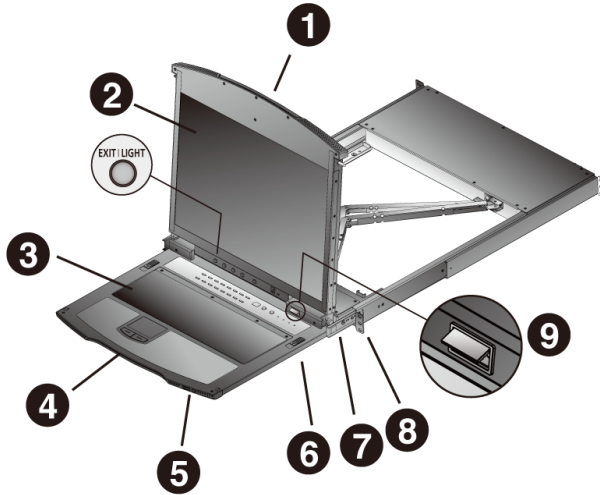

No.	Component	Description
1	Upper Handle	Pull to slide the LCD module out; push to slide the module in. See <i>Opening the Console</i> , page 27, for details on sliding the console in and out.
2	LCD Module	See <i>LCD Module</i> , page 12.
3	Keyboard Module	See <i>Keyboard Module</i> , page 11.
4	Lower Handle	Pull to slide the keyboard module out. See <i>Opening the Console</i> , page 27, for more details on sliding the console in and out.
5	Power LED	Lights (blue) to indicate that the unit is receiving power.
6	Keyboard Release Catch	These catches (one on each side) release the keyboard module so you can slide it away.
7	LCD Release Catch	These catches (one on each side) release the LCD module so you can slide it away.
8	Rack Mounting Brackets	The rack mounting brackets located at each corner of the unit secure the chassis to a system rack. See <i>Standard Rack Mounting</i> , page 16, for details.
9	LED Illumination Light	Illuminates the keyboard and touchpad to allow visibility in low-light conditions.

## Keyboard Module

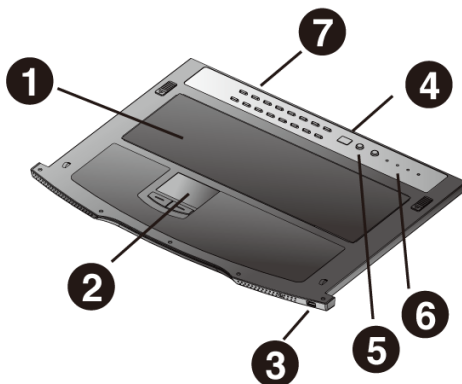

No.	Component	Description
1	Keyboard	Standard 105-key keyboard
2	Touchpad	Standard mouse touchpad
3	External Mouse Port	This USB-type mouse port is provided for users who prefer to use an external mouse.
4	Station ID LED	In a daisy chained installation, the Station ID of the currently selected station displays as a 2-digit figure in this panel. See <i>Port ID Numbering</i> , page 37 for further details.
5	Station Selection Area	<ul style="list-style-type: none"> <li>◆ The LED displays the station number that the port with the KVM focus is located on.</li> <li>◆ The left button shifts the KVM focus down the chain (Station 2 → Station 1, etc.). After Station 1, it cycles back to the last Station.</li> </ul> <p>The right button shifts the KVM focus up the chain. After the last Station, it cycles to Station 1.</p>
6	Lock LEDs & Reset Switch	<p>The Num Lock, Caps Lock, Scroll Lock LEDs are located here.</p> <p>A Reset Switch is located just to the right of the Lock LEDs. Press this recessed switch in with a thin object to perform a system reset.</p>
7	Port Selection Buttons and LEDs	<p>To access a Port on the currently selected Station press its corresponding port selection button. Indicator LEDs are built into the switches:</p> <ul style="list-style-type: none"> <li>◆ An <b>On Line</b> LED lights to indicate that the computer attached to its corresponding port is up and running.</li> </ul> <p>A <b>Selected</b> LED lights to indicate which port has the KVM focus.</p>

## LCD Module

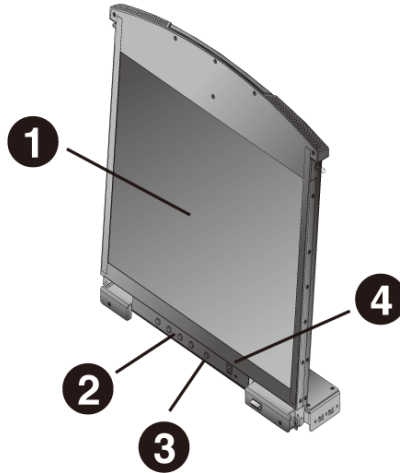

No.	Component	Description
1	LCD Display	To access the LCD monitor, slide the LCD module out and flip up the cover. See <i>Opening the Console</i> , page 27, for details on sliding the LCD module out.
2	LCD Controls	These buttons control the position and picture settings of the LCD display. See <i>LCD OSD Configuration</i> , page 33, for details.
3	LCD On/Off Button	Push this button to turn the LCD monitor on and off. The button lights when the LCD monitor is off to indicate that only the monitor is off – not the KVM switch itself.)
4	Firmware Upgrade Section	<p><b>Firmware Upgrade Port:</b> The Firmware Upgrade Cable that transfers the firmware upgrade data from the administrator's computer to the KL1508Ai / KL1516Ai plugs into this RJ-11 connector.</p> <p><b>Firmware Upgrade Switch:</b> During normal operation this switch should be in the NORMAL position. If firmware upgrade fails, this switch is used to recover the situation. See <i>Recovering from Failed Firmware Upgrade</i>, page 168, for details.</p>



## Rear View

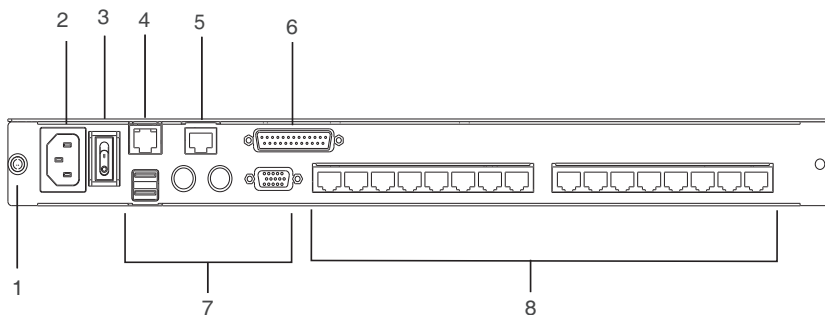

No.	Component	Description
1	Grounding Terminal	The grounding wire used to ground the switch attaches here.
2	Power Socket	This is a standard 3-pin AC power socket. The power cord from an AC source plugs in here.
3	Power Switch	This is a standard rocker switch that powers the unit on and off.
4	LAN Port	The cable that connects the to the LAN plugs in here. The LEDs indicate data transmission speed: ORANGE: 100 Mbps / GREEN: 1000 Mbps.
5	PON Port	This connector is provided for a Power over the Net™ (PON) unit to plug into. A PON device allows computers attached to the KL1508Ai / KL1516Ai to be booted remotely over the net. Contact your dealer for more details.
6	Daisy Chain Port	When Daisy Chaining Units (See <i>Daisy Chaining</i> , page 25), the daisy chain cable plugs in here.
7	Local Console Port Section	If this is a Single Station installation, or if this is the First Station of a daisy chained installation, the keyboard, monitor, and the mouse that make up the Local Console plug in here.
8	KVM Port Section	The Cat 5e/6 cables that link to the KVM Adapter Cables (which link to the computers) plug in here.

\* The KL1516Ai is pictured above. The KL1508Ai rear panel is the same as that of the KL1516Ai, except that it has 8 KVM ports instead of 16.

This Page Intentionally Left Blank

## Chapter 2

# Hardware Setup

### Before You Begin

---



1. Important safety information regarding the placement of this device is provided on page 193. Please review it before proceeding.
2. Make sure that power to all the devices you will be connecting up has been turned off. You must unplug the power cords of any computers that have the Keyboard Power On function.
3. Packing material has been inserted to protect the KL1508Ai / KL1516Ai during shipping. Slide the LCD module out (see *Opening the Console*, page 27), until the packing material is visible. Remove the packing material before installing the unit, as shown in the diagram below.

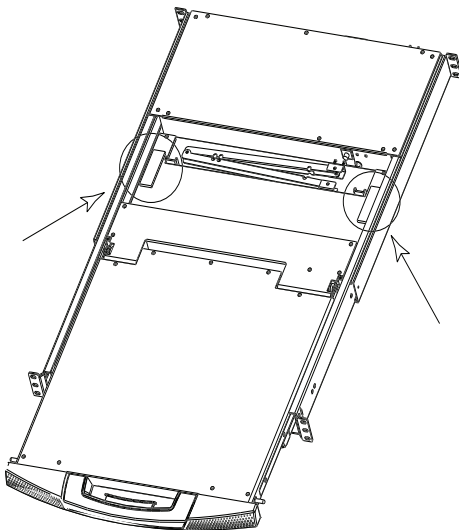

## Standard Rack Mounting

---

A standard rack mounting kit is provided with your KL1508Ai / KL1516Ai. The kit enables the switch to be mounted in a rack with a depth of 42–77 cm.

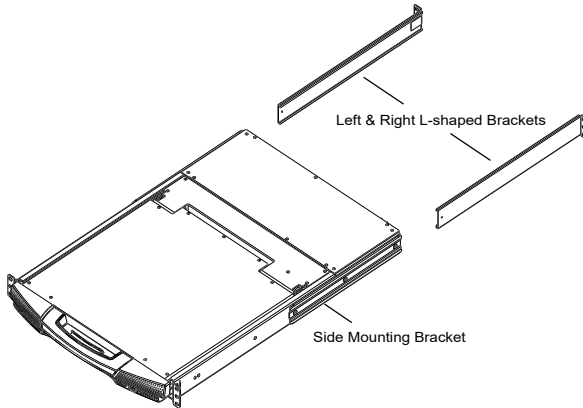

- 
- Note:**
- ◆ It takes two people to mount the console.
  - ◆ The standard rack mounting kit does not include screws or cage nuts. If you need additional screws or cage nuts, contact your rack dealer.
-

To rack mount the switch, do the following:

1. Have one person position the unit in the rack and hold it steady. Have the second person screw the front brackets to the rack.

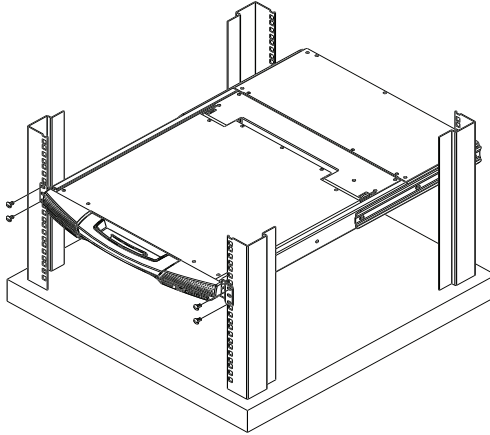

2. While the first person still holds the unit in place, the second person slides the left & right L-shaped brackets into the unit's side mounting brackets from the rear, installing four screws in the brackets to secure them in place.

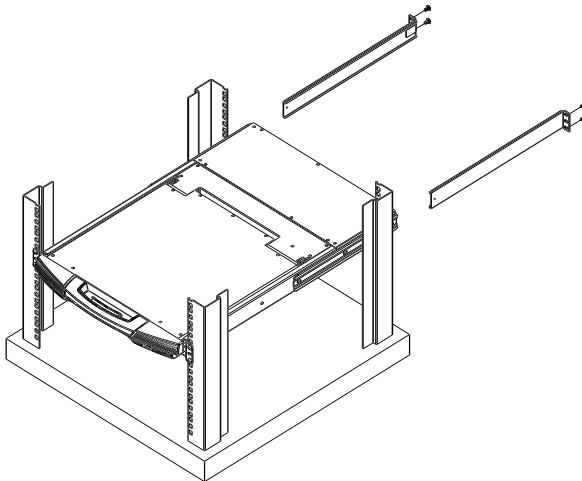

3. After the L-shaped brackets are secured, tighten all the screws.  
Allow at least 5.1 cm on each side for proper ventilation, and at least 12.7 cm at the back for the power cord and cable clearance.

## Front-L Brackets Mounting

To have a comfortable and safe posture, install the Front-L Brackets which provide an extension at the front of the rack to help the unit slide further out and thus allowing you to tilt the LCD screen more. Instructions to use this option are shown below:

1. Attach the left and right Front-L brackets to the front of the rack, placing screws in the tabs to secure them in place.

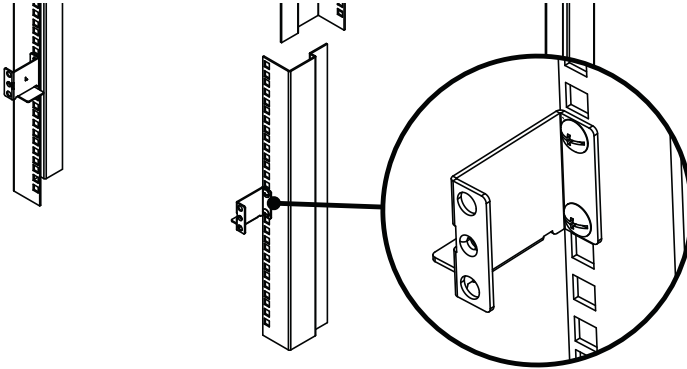

**Note:** Rack screws are not provided to mount the unit. We recommend that you use M5 x P0.8 screws.

2. Have one person position the unit in the rack and hold it steady. Have the second person screw the front brackets to the front-L bracket.

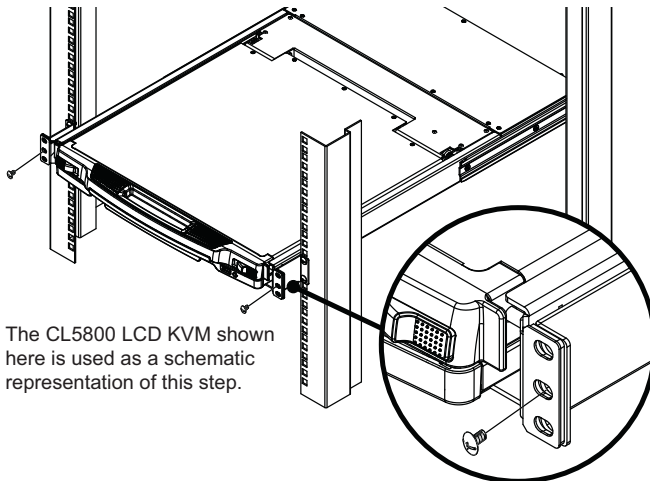

The CL5800 LCD KVM shown here is used as a schematic representation of this step.

3. While the first person still holds the unit in place, the second person slides the left & right L-shaped brackets into the unit's side mounting brackets from the rear, installing four screws in the brackets to secure them in place.

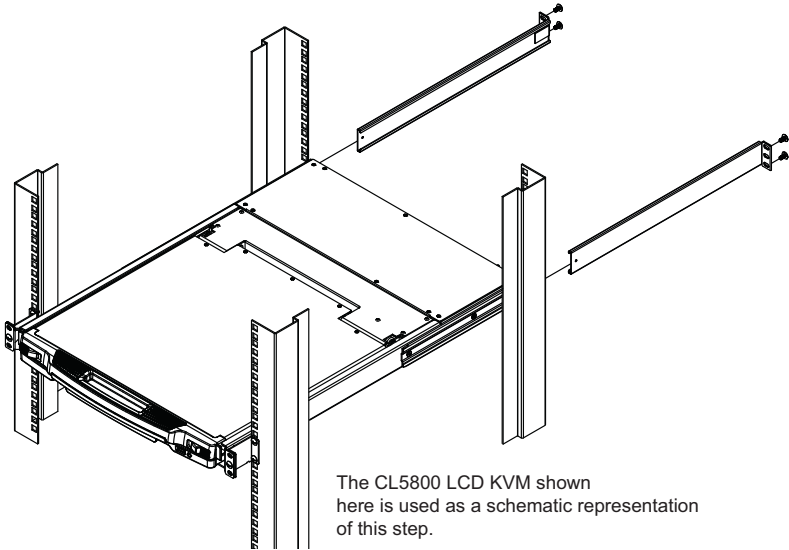

4. After the L-shaped brackets are secured, tighten all the screws.  
Allow at least 5.1 cm on each side for proper ventilation, and at least 12.7 cm at the back for the power cord and cable clearance.

## Optional Rack Mount Kits

---

For convenience and flexibility, optional rack mount kits are available and are listed in the table below:

Mounting Kit	Description
Standard Long Rack Mount Kit	This kit is the long-railed version of your standard mounting kit that lets you fit your device to racks with greater depth.
Easy Installation Rack Mount Kit	This kit is designed to be easy to install and can be installed by one person

- 
- Note:**
- ◆ For more information, visit the product webpage and refer to the **Compatible Accessories**.
  - ◆ For detailed installation steps, visit the product webpage and refer to the *Optional Rack Mount Kits Installation Guide*.
-



---

## Single Stage Installation

---

In a Single Stage installation, there are no additional switches daisy chained down from the first unit. To set up a single stage installation, refer to the installation diagrams beginning on the following page (the numbers in the diagram correspond to the numbers of the installation steps), and do the following:

1. Ground the KL1508Ai / KL1516Ai by connecting one end of a grounding wire to the grounding terminal, and the other end of the wire to a suitable grounded object.

---

**Note:** Do not omit this step. Proper grounding helps to prevent damage to the unit from surges or static electricity.

---

2. If you choose to install an external console, plug your keyboard, monitor, and mouse into the *Console Ports* located on the switch's rear panel. The ports are color coded and marked with an icon to identify themselves.

---

**Note:** This step is optional.

---

3. For each of the computers you are installing, use Cat 5e cable to connect any available KVM port to a KVM adapter cable that is appropriate for the computer you are installing. (See *KVM Adapter Cables*, page 7, for adapter cable details.)

---

**Note:** The maximum supported distance to the adapter cable is 50 m.

---

4. Connect the KVM Adapter cable to the computer. Refer to the *KVM Adapter Cable Installation Diagram*, page 23, to plug the adapter cable connectors into their respective ports on the computers you are installing.
5. Plug the LAN or WAN cable into the KL1508Ai / KL1516Ai's LAN port.
6. Connect the power cord to the switch and to an AC power source.

After the KL1508Ai / KL1516Ai is cabled up, you can turn on the power. After the switch is powered up, you can turn on the servers.

## Single Stage Installation Diagram

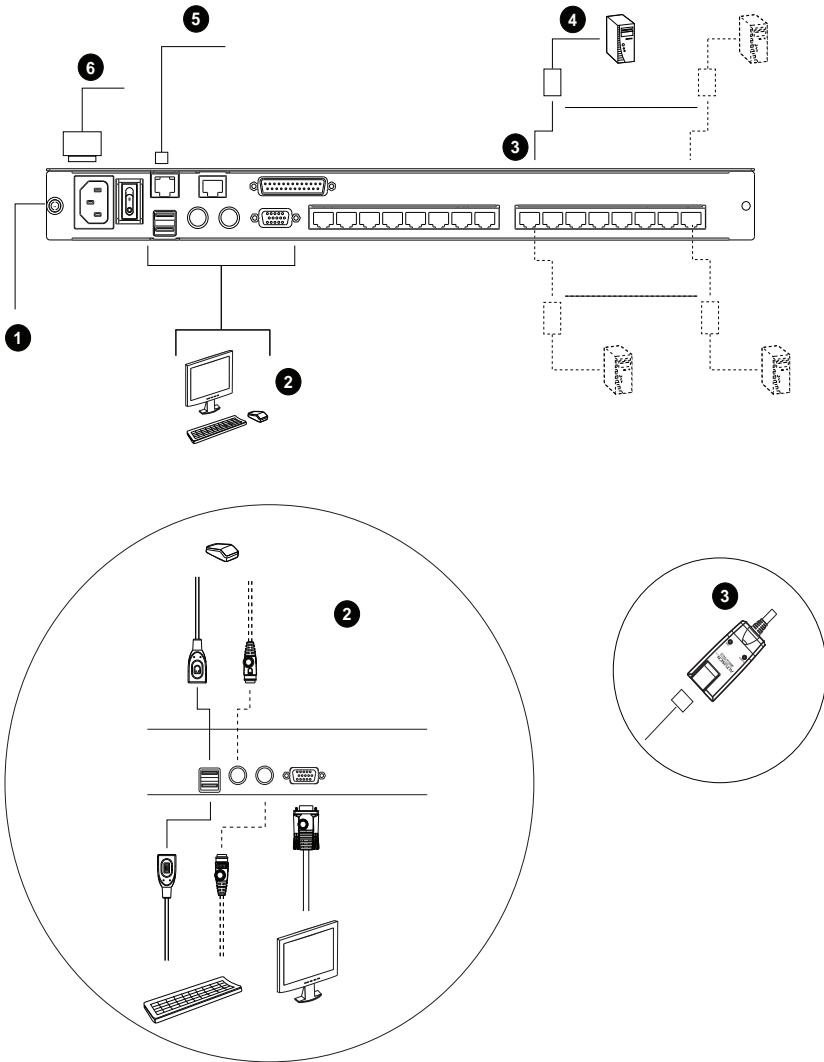

## **KVM Adapter Cable Installation Diagram**

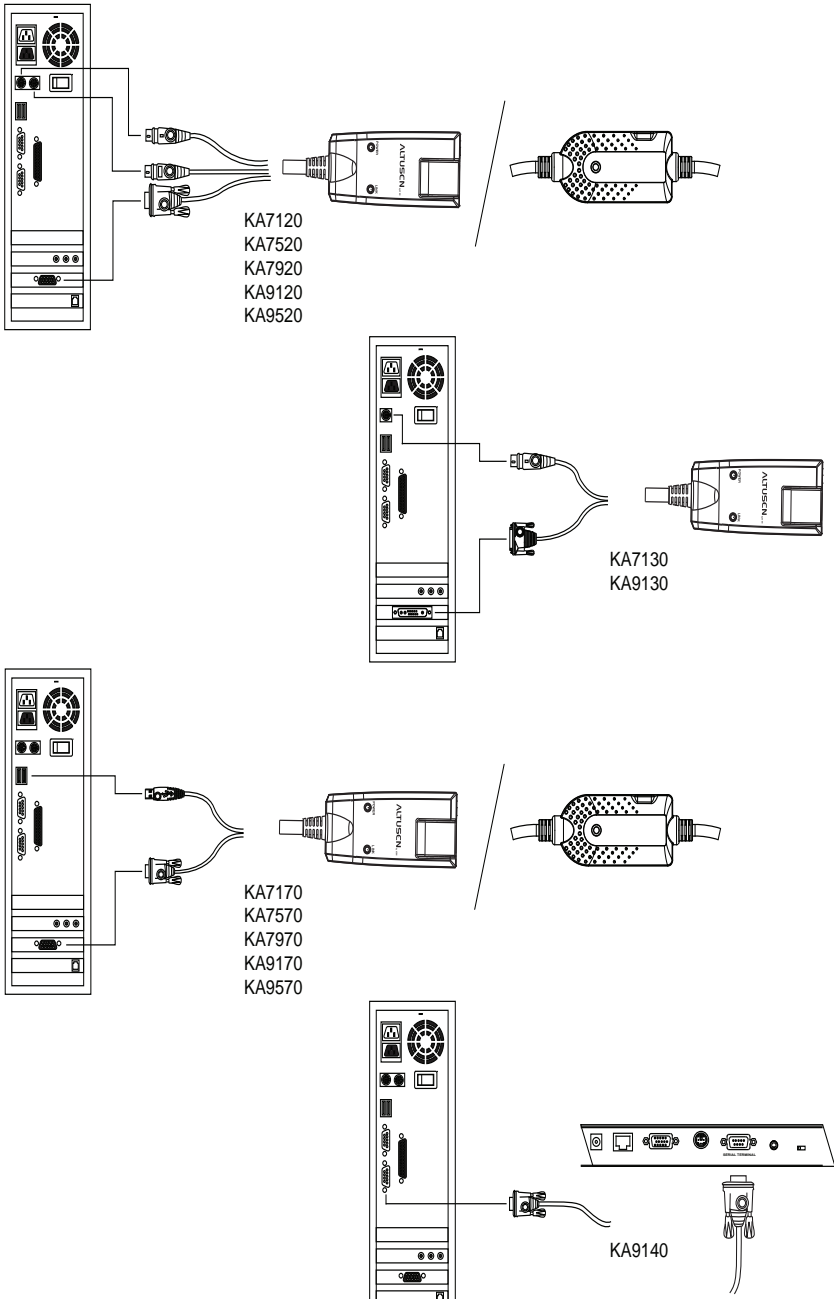

## **KVM Adapter Cable Installation Diagram cont.**

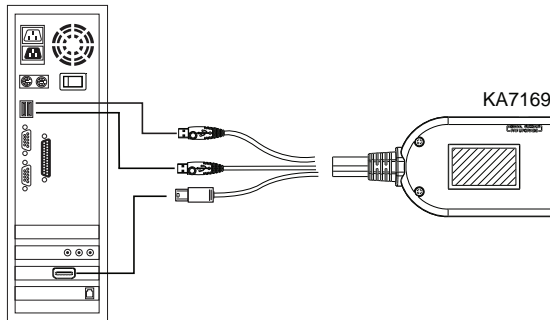
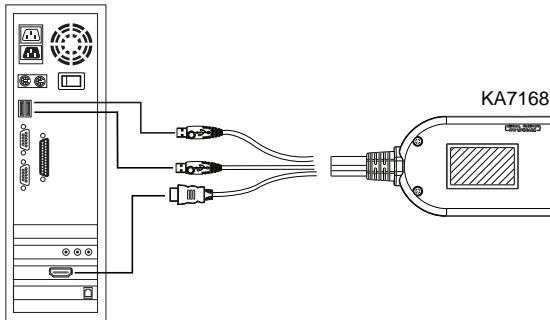
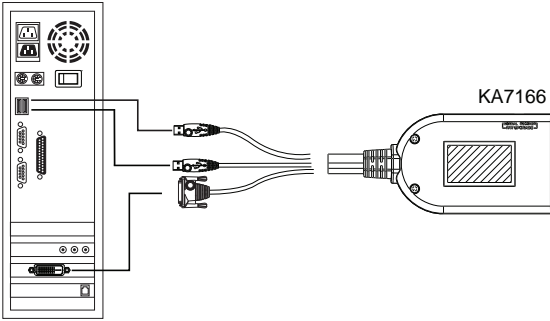

---

## Daisy Chaining

---

To control even more computers, up to 15 additional compatible KVM switches can be daisy chained from the original KL1508Ai or KL1516Ai. As many as 256 computers can be controlled from a single console in a complete installation.

---

**Note:** Refer to the table *Supported Devices*, page 222 for a list of ATEN switches that can be installed on a KL1508Ai / KL1516Ai daisy chain.

---

Tables showing the relation between the number of computers and the number of compatible KVM switch units needed to control them are provided on page 221.

To set up a daisy chained installation, make sure that power to all the devices you will be connecting up has been turned off, and refer to the *Daisy Chain Installation Diagram*, page 26 as you do the following:

1. Use a daisy chain cable set to connect the *Chain Out* port of the first station (the KL1508Ai / KL1516Ai unit) to the *Chain In* port of the chained compatible KVM Switch unit (first station out to second station in, second station out to third station in, etc.).

---

**Note:** 1. You cannot use the chain in port of the First Station.

2. Daisy chain cable sets require a separate purchase. See your dealer for details.
- 

2. Cable up the computers and the switch according to the information provided under *Single Stage Installation*, page 21.
  3. Repeat the above for any other switches you want to add to the chain.
  4. Power up the installation according to the following procedure:
    - a) Plug in the power cord for the first station. Wait for the unit to ascertain its station ID and display it on the Station ID LED. (The station ID for the first stage unit is 01, the ID for the second stage unit is 02, the ID for the third stage unit is 03, etc.)
    - b) Power on each station on the installation in turn (second station, then third station, etc.). In each case, wait for the station ID to be ascertained and displayed before powering on the next station.
    - c) After all the stations are up, power on the computers.
-

## Daisy Chain Installation Diagram

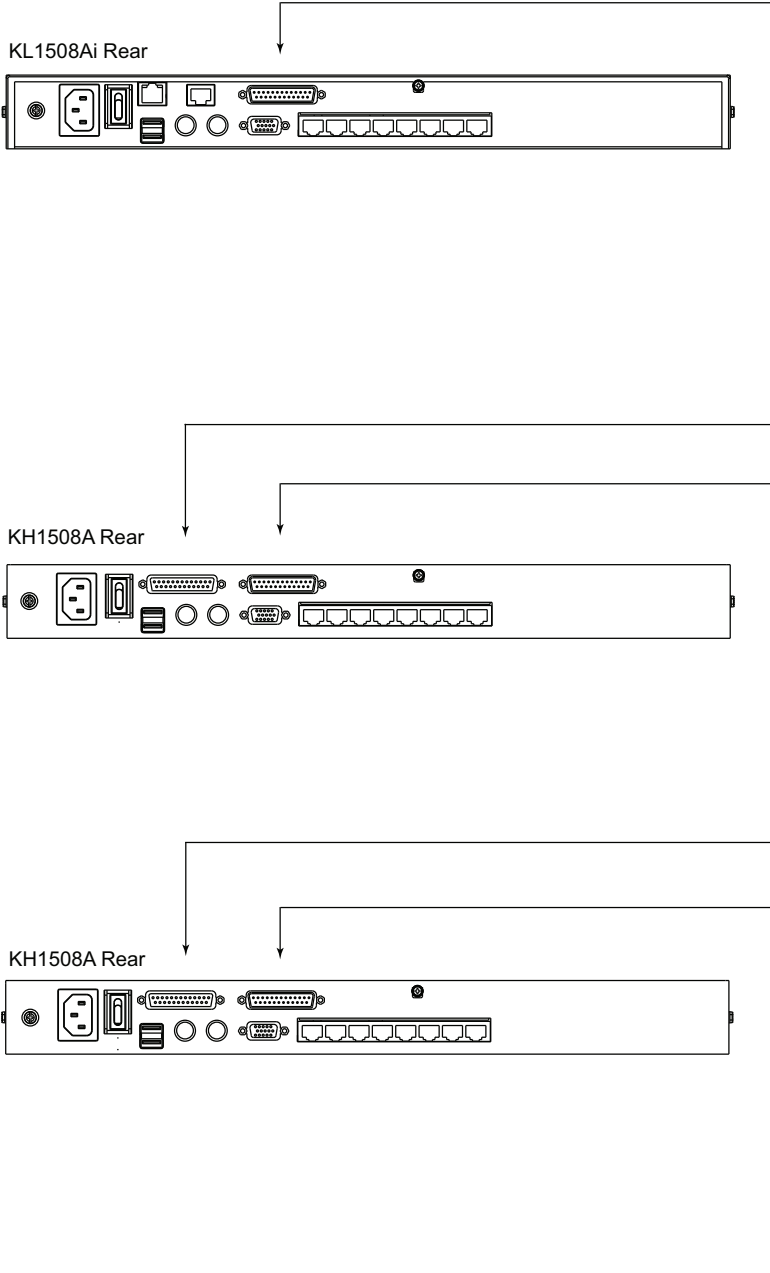

# Chapter 3

## Basic Operation

### Opening the Console

---

The KL1508Ai / KL1516Ai's console consists of two modules: an LCD display module located under the top cover; and a keyboard/touchpad module below the LCD module.

The modules can either slide together, or independently. This allows you to have the LCD display available for viewing while the keyboard/touchpad module is conveniently out of the way when not in use.

### Opening Separately

1. Pull the release catch to release the console, and pull the top panel a few centimeters toward you. Once the console has been released, you can let go of the catch.

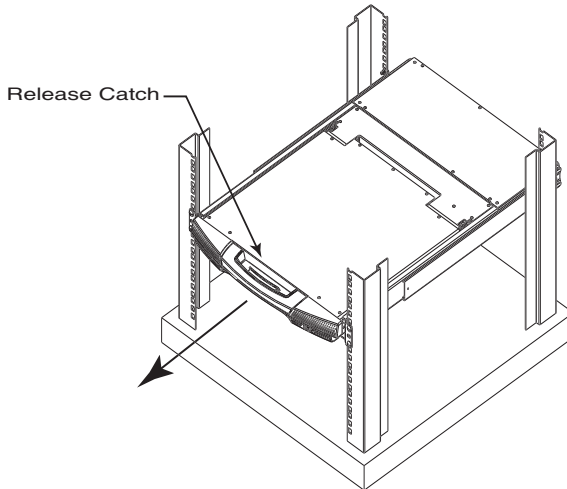

2. Pull the top panel all the way out until it clicks into place.

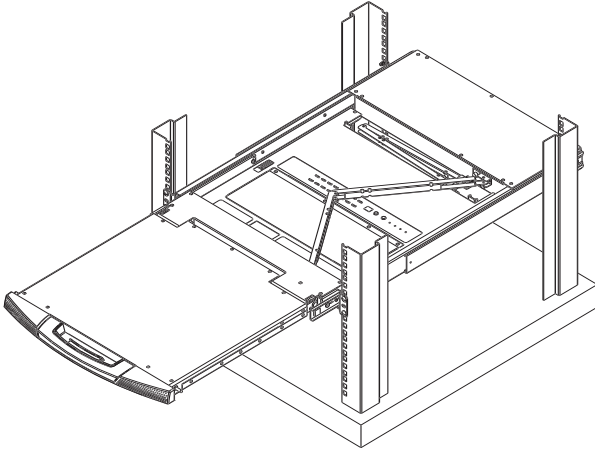

3. Rotate the top panel all the way back to expose the LCD screen.

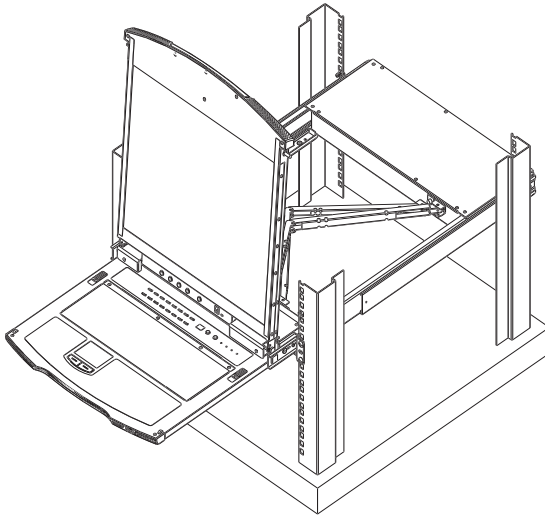



4. Reach underneath and pull the keyboard module all the way out until it clicks into place.

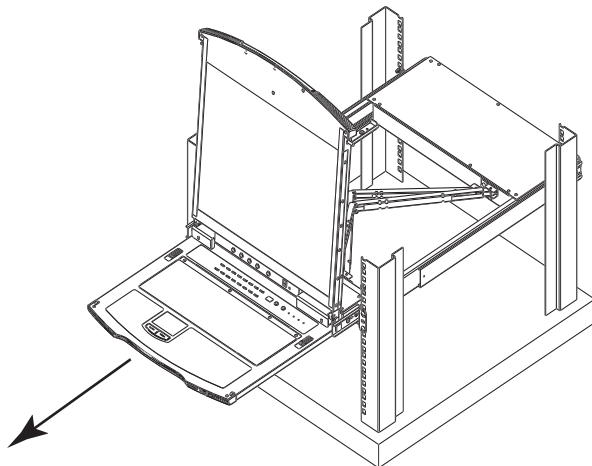

### **Opening Together**

Refer to the diagrams in the *Opening Separately* section as you do the following:

1. Pull the release catch and pull the top and bottom panels out until the keyboard module clicks into place.

---

**Note:** Once the console has been released, you can let go of the catch.

---

2. Pull the top panel the rest of the way out until it clicks into place.
3. Rotate the top panel all the way back to expose the LCD screen.

---

**Note:** Refer to the warning regarding placing excessive weight on the keyboard module on the following page.

---

## Operating Precautions

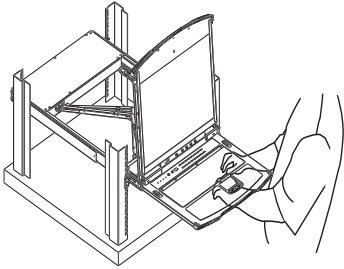
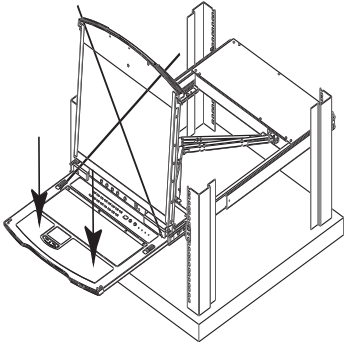

The maximum load bearing capacity of the keyboard module is 30kg. Failure to heed the information below can result in damage to the keyboard module.

	<p>RIGHT</p> <p>Rest your hands and arms lightly on the keyboard module as you work.</p>
	<p>WRONG!</p> <ul style="list-style-type: none"><li>◆ <b>DO NOT</b> lean your body weight on the keyboard module.</li><li>◆ <b>DO NOT</b> place heavy objects on the keyboard module.</li></ul>

## Closing the Console

---

1. Pull the release catches located on either side of the keyboard toward you to release the keyboard module, then slide the module slightly in.

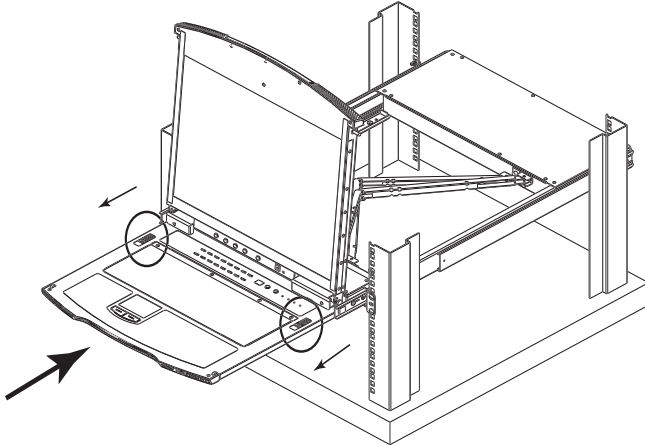

2. Let go of the catches. Using the front handle, push the keyboard module all the way in.

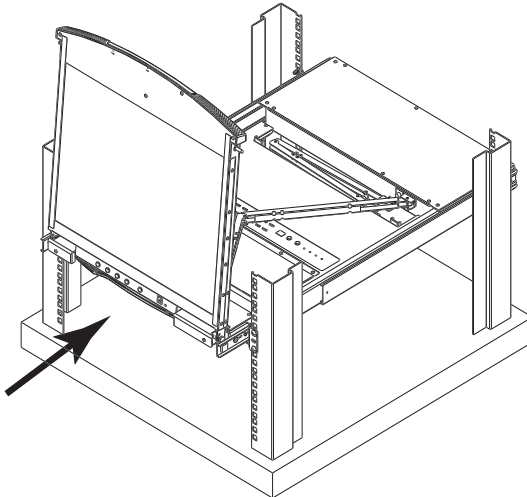

3. Rotate the LCD module all the way down, then pull the rear catches to release the LCD module.

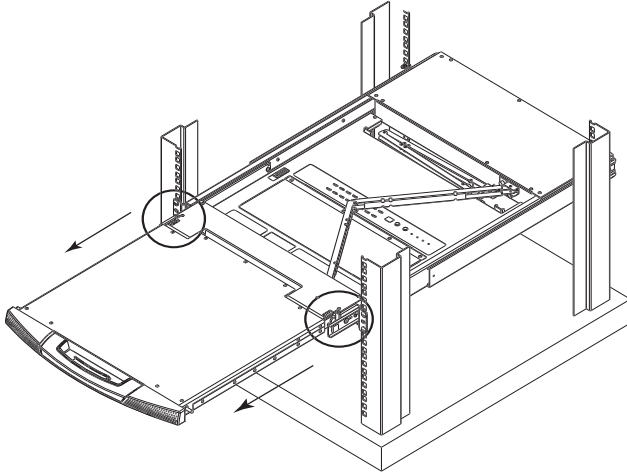

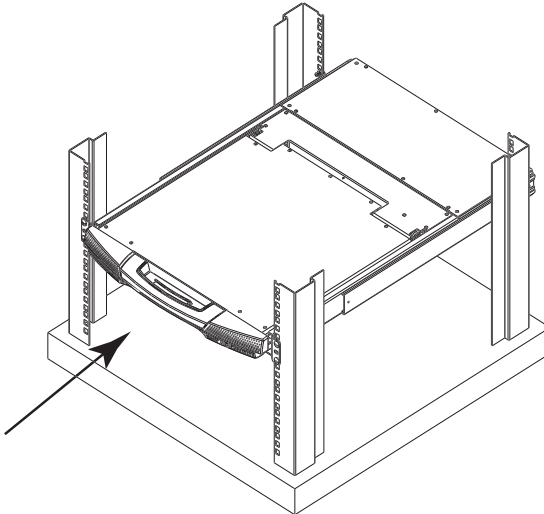

4. Using the front handle, push the module all the way in.



## LCD OSD Configuration

### The LCD Buttons

The LCD OSD allows you to set up and configure the LCD display. Four buttons (see *LCD Controls*, page 12), are used to perform the configuration, as described in the table below:

Button	Function
MENU	When you have not entered the LCD OSD Menu function, pressing this button invokes the Menu function and brings up the Main Menu.
	When navigating through the menus, this button moves you right or up. When making an adjustment, it increases the value.
	When navigating through the menus, this button moves you left or down. When making an adjustment, it decreases the value.
EXIT	<ul style="list-style-type: none"> <li>◆ When you have not entered the LCD OSD Menu function, pressing this button performs an auto adjustment. An auto adjustment automatically configures all the settings for the LCD panel to what the OSD considers their optimum values to be.</li> <li>◆ When you have entered the LCD OSD Menu function, pressing this button exits the current menu and returns you to the previous menu. Use it to leave an adjustment menu when you are satisfied with the adjustment you have made.</li> <li>◆ When you are at the Main Menu, pressing this button exits the LCD OSD.</li> </ul>

## **The Adjustment Settings**

An explanation of the LCD OSD adjustment settings is given in the table below:

<b>Setting</b>	<b>Explanation</b>
Brightness	Adjusts the background black level of the screen image.
Contrast	Adjusts the foreground white level of the screen image.
Phase	If pixel jitter or horizontal line noise is visible on the display, your LCD may have the wrong phase setting. Adjust the phase setting to eliminate these problems.
Clock	If vertical banding is visible on the display, your LCD may have the wrong clock setting. Adjust the clock setting to eliminate vertical banding.
H-Position	Positions the display area on the LCD panel horizontally (moves the display area left or right).
V-Position	Positions the display area on the LCD panel vertically (moves the display area up or down).
Color Temperature	Adjusts the color quality of the display. You can adjust the "warmth" value, color balance, etc. The <i>Adjust Color</i> selection has a further submenu that lets you fine tune the RGB values.
Language	Selects the language that the OSD displays its menus in.
OSD Duration	Lets you set the amount of time that the OSD displays on the screen. If there is no input for the amount of time you choose, the OSD display turns off.
Reset	Resets the menu and submenu adjustments (except for language settings) to the original factory default settings.

## Port Selection

---

KL1508Ai / KL1516Ai installations provide three methods to obtain instant access to any computer in your installation: Manual, OSD/GUI, and *Hotkey*.

### Manual

For manual port selection, simply press the Port Switch that corresponds to the device you wish to access.

### OSD / GUI

The KL1508Ai / KL1516Ai provides menu driven interfaces to the computer switching procedure. There are two systems: A text-based OSD when you log in from the local console; and a graphical user interface (GUI) when you log in remotely over the internet. Local console OSD operation is discussed in the next chapter; GUI operation is discussed from Chapter 5 onwards for Internet browser, and Windows and Java logins.

### Hotkeys

Hotkeys allow you to conveniently provide KVM focus to a particular computer from the local console keyboard, instead of having to manually select them by pressing Port Selection switches. See *Hotkey Port Control*, page 55, for details.

## Hot Plugging

---

The KL1508Ai / KL1516Ai supports hot plugging – components can be removed and added back into the installation by unplugging and replugging their cables from their ports without the need to shut the unit down. In order for hot plugging to work properly, however, the procedures described below must be followed.

### **Hot Plugging Stations**

You can switch station positions by simply unplugging from the old parent and plugging into a new one. After you do, in order for the OSD menus to correspond to the change, you must reset the OSD. See *RESET STATION IDS*, page 48, for details.

### **Hot Plugging KVM Ports**

After switching KVM ports, in order for the OSD menus to correspond to the change, you must manually reconfigure the OSD information for the new Port information. See *F3: SET*, page 44, and the Port Setting selections under the *F4 ADM* function, page 47, for details.

---

**Note:** If the computer's Operating System doesn't support hot plugging, this function may not work properly.

---

### **Hot Plugging Console Ports**

Keyboard, monitor, and mouse can all be hot plugged. When hot plugging the mouse:

- ♦ You may unplug the mouse and plug it back in again (to reset the mouse, for example), as long as you use the *same* mouse.
- ♦ If you plug in a different mouse, all the stations and all the computers on the installation must be shut down for 10 seconds, then restarted following the Power Up Sequence described under Step 6 on page 25.
- ♦ Some older operating systems may not support hot-plugging.

---

**Note:** If, after hot plugging (or at any other time), there is no response to keyboard and/or mouse input, perform a Keyboard and Mouse Reset by pressing in the Reset switch (see page 61).

---



---

## Powering Off and Restarting

---

If it becomes necessary to power off the KL1508Ai / KL1516Ai, or if the switch loses power and needs to be restarted, before starting it back up you must follow these procedures:

1. Shut down all the computers that are attached to it.

---

**Note:** You must unplug the power cords of any computers that have the Keyboard Power On function.

---

2. Wait 10 seconds then power it back on. If you have shut down more than one station, power up the highest station first and work your way down to the lowest one. Wait for each station to display its Station ID on the front panel LED before powering on the next one.
3. After the station(s) is (are) up, power the computers back on.

---

## Port ID Numbering

---

Each computer on the installation is assigned a unique Port ID. The Port ID is a one or two segment number that is determined by the Stage Level and KVM Port number of the KVM switch that the computer is connected to.

The first segment represents the KVM Port number of the First Stage unit; the second segment represents the KVM Port number of the Second Stage unit.

A computer attached to a First Stage unit has a one segment Port ID (from 1–16) that corresponds to the KVM Port number that it is connected to.

A computer attached to a Second Stage unit has a two segment Port ID:

- ◆ The second segment (from 1–16), represents the KVM Port number on the Second Stage unit that the computer is connected to. The first segment (from 1–16) represents the KVM Port number on the First Stage unit that the Second Stage unit links back to.
- ◆ For example, a Port ID of 12–3 refers to a computer that is connected to KVM Port 3 of a Second Stage unit that links back to KVM Port 12 of the First Stage unit.

This Page Intentionally Left Blank

# Chapter 4

## OSD Operation

### OSD Overview

---

The On Screen Display (OSD) is a menu driven method to handle computer control and switching operations. All procedures start from the OSD Main Screen. To display the Main Screen, tap the OSD hotkey twice.

The default hotkey is [Scroll Lock]. You can change the hotkey to the Ctrl key or the Alt key if you like (see *OSD HOTKEY*, page 44).

- 
- Note:**
1. If you use the Ctrl or Alt key method you must press the same Ctrl or Alt key both times.
  2. Once you start the OSD, the keyboard lock will be controlled by the device. When the OSD is being accessed, the number lock and caps lock will always be on and usernames/passwords are not case-sensitive.
- 

The OSD incorporates a two level (administrator / user) password system. Before the OSD Main Screen comes up, a login dialog box appears that asks for a username and password. You must provide a valid username and password in order to continue.

The first time that the OSD is accessed, you must use the default username and password. The default username is *administrator* and the default password is *password*. For security purposes, it is STRONGLY recommended that you change the password.

After logging in with the default username and password, the OSD Main Screen opens in Administrator mode. In this mode, you have administrator privileges, with access to all administrator and user functions, and can set up operations (including password authorization for the future), as you would like.

When you invoke the OSD, a screen similar to the one below appears:

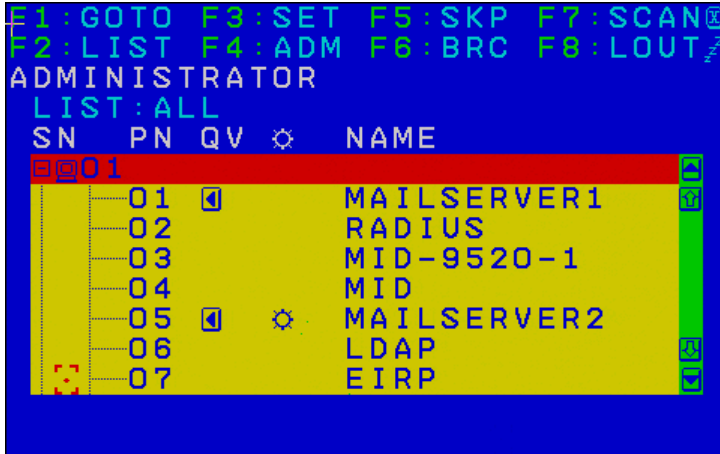

**Note:** The diagram depicts the Administrator's Main Screen. The User Main Screen does not show the **F4** and **F6** functions, since these are reserved for the administrator and can't be accessed by ordinary users.

## Manufacturing Number

The “MFG Number” (Manufacturing Number) is an internal serial number used by ATEN’s factory and technical support staff to identify products. This number does not affect products’ warranty. If your product requires after-sales services, you may provide the MFG Number to ATEN’s sales or technical support staff to identify the product and model number.

## OSD Navigation

- ◆ To dismiss the menu, and deactivate the OSD, click the **X** at the upper right corner of the OSD Window or press **Esc**.
- ◆ To Logout click **F8** or the **ZZ<sup>Z</sup>** symbol at the top of the Main Screen, or press **[F8]**.
- ◆ The OSD uses a tree view. To see the ports for a particular station, click the plus sign [ **+** ] in front of the station number. The port number list drops down. To dismiss the list, click the circle symbol [ **o** ] in front of the station number.
- ◆ To move up or down through the list one line at a time, click the up and down triangle symbols (**▲▼**) or use the up and down arrow keys. If there are more list entries than there is room for on the Main Screen, the screen will scroll.
- ◆ To move up or down through the list one screen at a time, click the up and down arrow symbols (**↑↓**), or use the [Pg Up] and [Pg Dn] keys. If there are more list entries than there is room for on the Main Screen, the screen will scroll.
- ◆ To bring the KVM focus to a port, double-click it, or move the highlight bar to it and then press **[Enter]**.
- ◆ After executing any action, you automatically go back to the menu one level above.

## OSD Main Screen Headings

Heading	Explanation
SN-PN	This column lists the port ID numbers (station number-port number) for all the KVM ports on the installation. The simplest method to access a particular computer is to click it, or move the highlight bar to it, and then press <b>[Enter]</b> .
QV	If a port has been selected for Quick View scanning an arrowhead displays in this column.
	The computers that are powered on and are online have a sun symbol in this column.
NAME	If a port has been given a name (see <i>EDIT PORT NAMES</i> , page 47), its name appears in this column.

## OSD Functions

---

OSD functions are used to configure and control the OSD. For example, you can rapidly switch to any port, scan selected ports only, limit the list you wish to view, designate a port as a Quick View Port, create or edit a port name, or make OSD setting adjustments.

To access an OSD function:

1. Either click a function key field at the top of the Main Screen, or press a function key on the keyboard.
2. In the submenus that appear make your choice either by double clicking it, or moving the highlight bar to it, and then pressing [**Enter**].
3. Press [**Esc**] to return to the previous menu level.

### **F1: GOTO**

Accessing the GOTO function allows you to switch directly to a port either by keying in the port's name or its port ID.

- ♦ To use the Name method, key in **1**, key in the port's name, and then press [**Enter**].
- ♦ To use the Port ID method, key in **2**, key in the port ID, and then press [**Enter**].

---

**Note:** You can key in a partial name or port ID. The screen will show all the computers that the user has *View* rights to that match the name or port ID pattern, regardless of the current *List* settings (see *F2: LIST*, page 43, for details).

---

To return to the OSD Main Menu without making a choice, press [**Esc**].

## **F2: LIST**

Many of the switch's OSD functions only operate on the computers currently selected for listing on the Main Screen. Accessing this function lets you broaden or narrow the scope of ports that get listed. The submenu choices and their meanings are given in the table below:

<b>Choice</b>	<b>Meaning</b>
ALL	Lists all of the ports on the installation.
QUICK VIEW	Lists only the ports that have been selected as Quick View Ports.
POWERED ON	Lists only the ports that have attached computers Powered On.
QUICK VIEW + POWERED ON	Lists only the ports that have been selected as Quick View Ports, and that have their attached computers Powered On.

Move the highlight bar to the choice you want, then press **[Enter]**. An icon appears before the choice to indicate that it is the currently selected one.

### **F3: SET**

Accessing this function allows the administrator and each user to set up an individual working environment. A separate profile for each operator is stored by the OSD and is activated according to the username provided during login.

To change a setting:

1. Double-click it; or move the highlight bar to it, then press **[Enter]**.
2. After you select an item, a submenu with further choices appears. To make a selection, either double click it; or move the highlight bar to it, then press **[Enter]**. An icon appears before the selected choice to indicate which one it is. The settings are explained in the following table:

<b>Setting</b>	<b>Function</b>
OSD HOTKEY	Selects which hotkey activates the OSD function: [Scroll Lock] [Scroll Lock]; [Ctrl] [Ctrl] or [Alt] [Alt]. Since the [Ctrl] or [Alt] key combinations may conflict with programs running on the computers, the default is the [Scroll Lock] combination.
PORT ID DISPLAY POSITION	Allows you to position where the port ID appears on the monitor. The default is the upper left corner, but you can choose to have it appear anywhere on the screen. Use the mouse or the arrow Keys plus Pg Up, Pg Dn, Home, End, and 5 (on the numeric keypad with Num Lock off), to position the port ID display, then click or press [Enter] to lock the position and return to the Set submenu. <b>Note:</b> The setting affects the currently selected port. If you don't want to use the default position, you must change the setting for each port individually.
PORT ID DISPLAY DURATION	Determines how long a port ID displays on the monitor after a port change has taken place. There are two choices: <b>3 seconds</b> and <b>Off</b> .
PORT ID DISPLAY MODE	Selects how the port ID is displayed: the port number alone ( <b>PORT NUMBER</b> ); the port name alone ( <b>PORT NAME</b> ); or the port number plus the port name ( <b>PORT NUMBER + PORT NAME</b> ). The default is <b>PORT NUMBER + PORT NAME</b> .
SCAN DURATION	Determines how long the focus dwells on each port as it cycles through the selected ports in Auto Scan mode (see <i>F7: SCAN</i> , page 52). Key in a value from 1–255 seconds, then press <b>[Enter]</b> . Default is 5 seconds; a setting of 0 disables the Scan function.



Setting	Function
SCAN/SKIP MODE	<p>Selects which computers will be accessed under Skip mode (see <i>F5: SKP</i>, page 50), and Auto Scan mode (see <i>F7: SCAN</i>, page 52). Choices are:</p> <p><b>ALL</b> – All the ports which have been set Accessible;</p> <p><b>POWERED ON</b> – Only those ports which have been set Accessible and are Powered On;</p> <p><b>QUICK VIEW + POWERED ON</b> – Only those ports which have been set Accessible and have been selected as Quick View Ports and are Powered On. The default is ALL.</p>
SCREEN BLANKER	<p>If there is no input from the console for the amount of time set with this function, the screen is blanked. Key in a value from 1–30 minutes, then press <b>[Enter]</b>. A setting of 0 disables this function. The default is Off.</p>
HOTKEY COMMAND MODE	<p>Enables / Disables the Hotkey function (see <i>OSD Operation</i>, page 39), in case a conflict with programs running on the computers occurs. The default is On.</p>
HOTKEY	<p>This setting selects the Hotkey invocation keys (see <i>Hotkey Operation</i>, page 55). Choices are <b>[NUM LOCK] + [-]</b>, or <b>[CTRL] + [F12]</b>. The default is <b>[NUM LOCK] + [-]</b>.</p>
OSD LANGUAGE	<p>Sets the language that the OSD displays in. Choices are: English, German, Japanese, Simplified Chinese, Traditional Chinese, Spanish, Russian, and French. The default is English.</p>
SET CONSOLE KEYBOARD	<p>Sets the keyboard language mapping of the console keyboard. The default is Auto. If the switch does not automatically receive language mapping from the keyboard, it will set to English (US).</p>
SET LOGOUT TIMEOUT	<p>If there is no input from the console for the amount of time set with this function, the operator is automatically logged out. A login is necessary before the console can be used again.</p> <p>This enables other operators to gain access to the computers when the original operator is no longer accessing them, but has forgotten to log out. To set the timeout value, key in a number from 1–180 minutes, then press <b>[Enter]</b>. If the number is 0 (zero), this function is disabled. Default is Off.</p>
ACTIVATE BEEPER	<p>Choices are <b>Y</b> (for Yes), or <b>N</b> (for No). When activated, the beeper sounds whenever a port is changed, when activating the Auto Scan function (see <i>F7: SCAN</i>, page 52), or an invalid entry is made on an OSD menu. The default is On.</p>

(Continues on next page.)

*(Continued from previous page.)*

Setting	Function
PREFERRED RESOLUTION	<p>This function allows you to set the preferred resolution for a second external display* connected to the switches console port, which will be sent to the KVM adapter cables. The KVM adapter cables provide the connected computer's video card with EDID information about the monitor connected to the switch. This affects the video quality displaying on the external console monitor. Choices are:</p> <ul style="list-style-type: none"> <li>◆ <b>MONITOR DEFAULT SETTING</b> – Sends the EDID information provided by the switches LCD monitor – to the KVM adapter cable.</li> <li>◆ <b>Alternative Resolution</b> – Sends the alternative resolution (EDID information) selected for the external display connected to the switches console port, to the KVM adapter cables. Select a resolution that best suits the video display for the monitor connected to the switches console port.</li> </ul> <p><b>Note:</b> When using the built in LCD monitor the default resolution must be set to 1280x1024 60HZ. Only change the preferred resolution when connecting an external display to the console monitor port.</p>
TOUCHPAD	<p>Enables / Disables the touchpad function of the console. Choices are <b>Y</b> (for Yes), or <b>N</b> (for No). The active status (Touchpad On / Touchpad Off) is also shown.</p>

## **F4: ADM**

F4 is an administrator only function. Accessing this function allows the administrator to configure and control the overall operation of the OSD. To change a setting double click it; or use the up and down arrow keys to move the highlight bar to it, then press **[Enter]**.

After you select an item, a submenu with further choices appears. Double click the choice you want, or move the highlight bar to it, then press **[Enter]**. An icon appears before the selected choice. The settings are explained in the table on the next three pages:

<b>Setting</b>	<b>Function</b>
SET IP ADDRESS	<p>This function is used to select whether to assign the KL1508Ai/ KL1516Ai's IP address automatically (DHCP), or to give it a fixed IP address.</p> <ul style="list-style-type: none"> <li>◆ Enable DHCP to assign the IP address automatically.</li> <li>◆ Disable DHCP to assign a fixed IP address and specify the IP, Mask, and Gateway in the appropriate fields.</li> </ul> <p><b>Note:</b> The default setting for DHCP is disabled.</p>
EDIT PORT NAMES	<p>To identify which computer is attached to a particular port, every port can be assigned a name. This function allows the administrator to create, modify, or delete port names. To assign a port name:</p> <ol style="list-style-type: none"> <li>1. Click the port you want, or use the navigation keys to move the highlight bar to it, then press <b>[Enter]</b>.</li> <li>2. Key in the new port name, or modify/delete the old one. The maximum number of characters allowed for the port name is 14. Legal characters include: <ul style="list-style-type: none"> <li>◆ All alpha characters: <b>A–Z*</b></li> <li>◆ All numeric characters: <b>0–9</b></li> </ul> <p>*You can enter the port names in either upper or lower case however the OSD displays the port name only in UPPERCASE.</p> </li> <li>3. When you have finished editing, press <b>[Enter]</b> to have the change take effect. To abort the change, press <b>[Esc]</b>.</li> </ol>
RESTORE DEFAULT VALUES	<p>This function is used to undo all changes and return the setup to the original factory default settings (see <i>OSD Factory Default Settings</i>, page 225) – except for the <i>Names</i> settings that were assigned to the ports, which are saved.</p>
CLEAR THE NAME LIST	<p>This function clears the port name list.</p>

*(Continues on next page.)*

(Continued from previous page.)

Setting	Function
RESET STATION IDS	<p>If you change the position of one of the stations in the daisy chain, the OSD settings will no longer correspond to the new situation. This function directs the OSD to rescan the station positions of the entire installation and updates the OSD so that the OSD station information corresponds to the new physical layout.</p> <p><b>Note:</b> Only the station numbers get updated. Except for the port names, all administrator settings, for all of the computers affected by the change, have to be manually redone.</p>
SET OPERATING SYSTEM	<p>Specifies the operating platform of the computer attached to each port. You must configure each port on the installation. For each port, press the [Spacebar] to cycle through the choices (PC, Mac or Sun). Repeat until all the ports have been set, then press [Esc]. The default is PC.</p> <p><b>Note:</b> If you are installing a Sun or Mac computer it may not boot when you run it for the first time unless you first set the correct operating system for the port it is connected to.</p>
SET CAT 5 LENGTH	<p>Lets you specify how long the Cat 5e/6 cable between the port and the KVM adapter cable is. Press <b>[Spacebar]</b> to cycle through the cable length settings:</p> <p style="padding-left: 20px;"><b>S:</b> Short – for up to 25 m  <b>M:</b> Medium – for between 20 and 35 m  <b>L:</b> Long – for above 35 m</p> <p>An S, M, or L appears next to the port to indicate the choice.</p>
SET KEYBOARD LANGUAGE	<p>Sets the keyboard language layout for the computers attached to each port. Press <b>[Spacebar]</b> to cycle through the choices: The default is English (US).</p>
FIRMWARE UPGRADE	<p>In order to upgrade the KL1508Ai/KL1516Ai and adapter cable firmware you must first enable <i>Firmware Upgrade</i> mode with this setting.</p> <p>When you bring up this menu, the current firmware version of the KVM switch and the iCard will be displayed. Select <b>Y</b> to enable Firmware Upgrade mode, or <b>N</b> to leave this menu without enabling it.</p>
ADAPTER UPGRADE	<p>This function allows the administrator to check the firmware version of the KVM adapter cable. When you bring up this menu, the current firmware version levels display. See <i>FIRMWARE UPGRADE</i>, above, also.</p>
SET CONSOLE MODE	<p>This setting selects which console(s) (internal/external) are enabled:</p> <p style="padding-left: 20px;"><b>0</b> Both Consoles enabled  <b>1</b> LCD Console only  <b>2</b> External console only</p> <p>Use the spacebar to cycle through the choices. The default is 0. Changes will not be saved until you logout.</p>

---

SET VIDEO HV MODE	<p>This setting selects the video mode (separate or composite video sync signals) the port(s) (internal/external) is using. Press <b>[Spacebar]</b> to enter this setting and see a list of ports.</p> <p>Use the <b>[Spacebar]</b> to cycle through the choices. The choices are:</p> <ul style="list-style-type: none"><li><b>S</b> Separate (default)</li><li><b>C</b> Composite</li></ul> <p>Changes will not be saved until you exit to the main menu.</p> <p><b>Note:</b> If your dongle does not support video HV mode, the unit will emit a beeping sound whenever you cycle through the choices. The supported dongles are KA7170, KA7570, KA7166, KA7168 and KA7169.</p>
----------------------	--

---

## **F5: SKP**

This function enables you to easily skip backward or forward, switching the console focus from the currently active KVM Port to the previous or next available one.

- ◆ The selection of computers to be available for Skip mode switching is made with the *Scan/Skip* mode setting under the **F3 SET** function (see page 45).
- ◆ When you are in Skip mode, press:
  - ← To skip to the previous port in the List.
  - To skip to the next port in the List.
  - ↑ To skip to the last port of the previous station in the List.
  - ↓ To skip to the first port of the next station in the List.

---

**Note:** When you skip, you only skip to the previous or next available computer that is in the *Scan/Skip* mode selection (see page 45).

---

- ◆ If a port has been selected for *Scan/Skip* mode, when the focus switches to that port a left/right triangle symbol appears before its port ID display.
- ◆ While Skip mode is in effect, the console will not function normally. You must exit Skip mode in order to regain control of the console.
- ◆ To exit Skip mode, press the [Spacebar] or [Esc].

## **F6: BRC**

F6 is an administrator only function. When this function is in effect, commands sent from the console are broadcast to all available computers on the installation.

This function is particularly useful for operations that need to be performed on multiple computers, such as performing a system wide shutdown, installing or upgrading software, etc.

- ◆ While BRC mode is in effect, a speaker symbol appears before the port ID display of the port that currently has the console focus.
- ◆ While BRC mode is in effect, the mouse will not function normally. You must exit BRC mode in order to regain control of the mouse.
- ◆ To exit BRC mode, invoke the OSD (with the OSD Hotkey), then click the **F6** field, or press [F6], to turn BRC mode off.

## **F7: SCAN**

This function automatically switches among the available computers at regular intervals so that you can monitor their activity without having to take the trouble of switching manually.

- ◆ The selection of computers to be included for Auto Scanning is made with the *Scan/Skip* mode setting under the **F3 SET** function (see page 45).
- ◆ The amount of time that each port displays for is set with the *Scan Duration* setting under the **F3 SET** function (see page 44).
- ◆ As each computer is accessed, an **S** appears in front of the port ID display to indicate that it is being accessed under *Auto Scan* mode.
- ◆ While you are in Auto Scan mode, you can pause the scanning in order to keep the focus on a particular computer either by pressing **P**, or with a left click of the mouse. To resume scanning, press any key or left click again. See *Auto Scan Mode Switching*, page 58, for details.
- ◆ While Auto Scan mode is in effect, the console will not function normally. You must exit Auto Scan mode in order to regain control of the console.
- ◆ To exit Auto Scan mode, press the [Spacebar] or [Esc].



## **F8: LOUT**

Clicking the **F8** field, or pressing [**F8**], logs you out of the OSD and blanks the console screen. This is different from simply deactivating the OSD when you are at the Main Screen by pressing [Esc].

With this function you must log in all over again to regain access to the OSD, whereas with [Esc], all you have to do to reenter the OSD is tap the OSD Hotkey.

- 
- Note:**
1. When you reenter the OSD after logging out, the screen stays blank except for the login dialog box. You must input your username and password before you can continue (see page 39).
  2. If you reenter the OSD after logging out, and immediately use [Esc] to deactivate the OSD without having selected a port from the OSD menu, a Null Port message displays on the screen. The OSD hotkey will bring up the OSD Main Screen.
-

This Page Intentionally Left Blank

# Chapter 5

## Hotkey Operation

### Hotkey Port Control

---

Hotkey port control allows you to provide KVM focus to a particular computer directly from the keyboard. The KL1508Ai / KL1516Ai provides the following Hotkey port control features:

- ◆ Selecting the Active Port
- ◆ Auto Scan Mode Switching
- ◆ Skip Mode Switching
- ◆ Computer Keyboard / Mouse Reset

The following settings can also be controlled in *Hotkey* mode:

- ◆ Setting the Beeper
- ◆ Setting the Quick Hotkey
- ◆ Setting the OSD Hotkey
- ◆ Setting the Port Operating System
- ◆ Restoring the OSD Default Values

## Invoking Hotkey Mode

---

All Hotkey operations begin by invoking *Hotkey* mode.<sup>1</sup> To invoke *Hotkey* mode you may use two possible keystroke sequences shown below. Only one of the two key-sequences below can be operational (see *Setting the Hotkey key combination* on page 62):

### Number Lock and Minus Keys

1. Hold down the **[Num Lock]** key;
2. Press and release the **[Minus]** key;
3. Release the **[Num Lock]** key:  
**[Num Lock] + [-]**

### Control and F12 Keys

1. Hold down the **[Ctrl]** key;
2. Press and release the **[F12]** key;
3. Release the **[Ctrl]** key:  
**[Ctrl] + [F12]**

### Hotkey Mode Environment

When *Hotkey* mode is active:

- ♦ A command line appears on the monitor screen. The command line prompt is the word *Hotkey:* in white text on a blue background, and displays the subsequent Hotkey information that you key in.
- ♦ Ordinary keyboard and mouse functions are suspended – only Hotkey compliant keystrokes (described in the sections that follow), can be input.

### Exiting Hotkey Mode

Pressing **[Esc]** exits Hotkey mode.

---

1. Make sure that the *Hotkey Command Mode* function is enabled and that you key in the appropriate *Hotkey*. See page 45 for details.

## Selecting the Active Port

---

Each computer port is assigned a port ID (see *Port ID Numbering*, page 37). You can directly access any computer with a Hotkey combination that specifies the port ID that the computer is connected to. The steps are:

1. Enter the Hotkey mode with the:

**[Num Lock] + [-] or [Ctrl] + [F12]** combination.

2. Key in the port ID.

The port ID numbers display on the command line as you key them in. If you make a mistake, use **[Backspace]** to erase it.

3. Press **[Enter]**.

After you press **[Enter]**, the KVM focus switches to the designated computer and you automatically exit Hotkey mode.

---

**Note:** In Hotkey mode, the KVM focus will not switch to a port if an invalid switch or port number is entered. The Hotkey command line will continue to display on the screen until you enter a valid switch and port number combination, or exit Hotkey mode.

---

## Auto Scan Mode Switching

---

Auto Scan automatically switches among all the active computer ports that are accessible to the currently logged on user at regular intervals. This allows their activity to be monitored automatically (See *SKAN/SKIP MODE* of the OSD F3 SET function, page 45).

### Setting the Scan Interval

The amount of time Auto Scan keeps the focus on each port is set with the *SCANDURATION* setting of the OSD **F3 SET** function (see page 44). You can change the scan interval, before you activate Hotkey Auto Scanning, by entering the following Hotkey combination:

1. Enter the Hotkey mode:

**[Num Lock] + [-] or [Ctrl] + [F12]** combination.

2. Key in **[A] [n]**

Where **[A]** is the letter **A**, and **[n]** is a number from 1–255 that represents the length of the focus time in seconds.

The letter **A** and the numbers display on the command line as you key them in. Use **[Backspace]** to erase any wrong entry.

3. Press **[Enter]**

After you press **[Enter]**, you exit Hotkey mode, and are ready to start Auto Scanning.

### Entering Auto Scan

To enter the Auto Scanning mode, key in the following Hotkey combination:

1. Enter the Hotkey mode:

**[Num Lock] + [-] or [Ctrl] + [F12]** combination.

2. Press **[A] + [Enter]**.

- ♦ While you are in Auto Scan mode, you can pause the scanning to keep the focus on a particular computer by pressing **[P]**. When Auto Scanning is paused, the Command Line displays: **Auto Scan: Paused**.

When you want to keep the focus on a particular computer, *Pausing* is more convenient than exiting Auto Scan mode. When you resume scanning it starts at the computer where you paused. If you exited and

then restarted Auto Scanning, it starts, at the beginning, from the first computer on the installation.

To resume Auto Scanning, press any key. Scanning continues from the computer you paused at.

- ◆ While the Auto Scan mode is operating, ordinary keyboard and mouse functions are suspended - only Auto Scan mode compliant keystrokes can be input. You must exit Auto Scan mode to regain normal control of the console.

### **Exiting Auto Scan**

1. To exit Auto Scan mode press **[Esc]** or **[Spacebar]**. Auto Scanning stops when you exit Auto Scan mode.

## Skip Mode Switching

---

This feature allows you to switch between computers in order to monitor them manually. You can focus on a particular port for as long as you like – as opposed to auto-scanning, which automatically switches the port focus after a fixed interval.

### Entering Skip Mode

To enter *Skip* mode, key in the following Hotkey combination:

1. Enter the Hotkey mode by pressing the:  
**[Num Lock] + [-] or [Ctrl] + [F12]** combination.
2. Press one of the **[Arrow]** keys.

After you press one of the keyboard arrows, you automatically exit Hotkey mode and enter *Skip* mode where you can switch ports as follows:

←	Skips to the first accessible port. (See <i>SCAN/SKIP MODE</i> , page 45, for information regarding accessible ports.)
→	Skips to the next accessible port.
↑	Skips to the last accessible port of the previous station.
↓	Skips to the first accessible port of the next station.

Once you are in *Skip* mode, you can continue skipping by pressing the arrow keys. You do not have to use the **[Num Lock] + [-]** combination again.

While *Skip* mode is in effect, ordinary keyboard and mouse functions are suspended – only *Skip* mode compliant keystrokes can be input. You must exit *Skip* mode to regain normal control of the console.

### Exiting Skip Mode

1. To exit *Skip* mode, press **[Esc]** or **[Spacebar]**.



## Computer Keyboard / Mouse Reset

---

If either the keyboard or mouse stop functioning on the computer connected to the currently selected port, you can perform a keyboard / mouse reset on the computer by executing the following steps:

1. Enter the Hotkey mode with the:

**[Num Lock] + [-] or [Ctrl] + [F12]** combination.

2. Press **[F5]**.

After you press **[F5]** you automatically exit *Hotkey* mode and regain keyboard and mouse control on the computer connected to the KVM port. If you fail to regain keyboard / mouse control on the computer after pressing **[F5]**, perform a system reset. For more information see *Lock LEDs & Reset Switch*, page 11.

This function is essentially the same as unplugging and replugging the keyboard and mouse on the target computer.

## Setting the Hotkey Beeper ON/OFF

---

The beeper (see Activate Beeper, page 45) can be turned on and off with Hotkeys by the following steps:

1. Enter the Hotkey mode with the:

**[Num Lock] + [-] or [Ctrl] + [F12]** combination.

2. Press **[B]**.

After you press **[B]**, the beeper turns on or off. The command line displays *Beeper On* or *Beeper Off* for one second; then the message disappears and you automatically exit Hotkey mode.

## Setting the Hotkey key combination

---

The keys used to enter the *Hotkey Mode* (see *HOTKEY COMMAND MODE*, page 45) can be switched between:

**[Num Lock] + [-]**, and **[Ctrl] + [F12]**

by the following steps:

1. Enter the Hotkey mode with the:

**[Num Lock] + [-]** or **[Ctrl] + [F12]** combination.

2. Press **[H]**.

After you press **[H]**, the command line displays *HOTKEY HAS BEEN CHANGED* for one second; then the message disappears and you automatically exit *Hotkey* mode.

## Setting the OSD Hotkey combination

---

The *Hotkeys* used to access the *OSD* (see *OSD HOTKEY*, page 44) can be switched between **[Scroll Lock]**, **[Scroll Lock]**, **[Ctrl]**, **[Ctrl]**, and **[Alt]**, **[Alt]** by the following steps:

1. Enter the Hotkey mode with the:

**[Num Lock] + [-]** or **[Ctrl] + [F12]** combination.

2. Press **[T]**.

After you press **[T]**, the command line displays *HOTKEY HAS BEEN CHANGED* for one second; then the message disappears and you automatically exit *Hotkey* mode.

---

## Setting the Port Operating System

---

A port's operating system configuration can be matched to that of the computer attached to the port by performing the following steps:

1. Enter the Hotkey mode with the:  
[Num Lock] + [-] or [Ctrl] + [F12] combination.
2. Press a [Function] key, where [Function] refers to one of the function keys in the following table:

Key	Description
F1	Sets the Port OS to Windows
F2	Sets the Port OS to Mac
F3	Sets the Port OS to Sun

After pressing a function key you automatically exit *Hotkey* mode.

---

## Restore the Default Values

---

This administrator-only Hotkey restores the KL1508Ai / KL1516Ai default values (see on page 163) by performing the following steps:

1. Enter the Hotkey mode with the:  
[Num Lock] + [-] or [Ctrl] + [F12] combination.
2. Press [R].
3. Press [Enter].

After you press [Enter], the command line displays *RESET TO DEFAULT SETTING* for three seconds; then the message disappears and you automatically exit *Hotkey* mode.

## Hotkey Summary Table

[Num Lock] + [-] or [Ctrl] + [F12]	[A] [Enter]	Invokes <i>Auto Scan</i> mode. When <i>Auto Scan</i> mode is in effect, [P] or left-click pauses auto-scanning. When auto-scanning is paused, pressing any key or another left-click resumes auto-scanning.
	[B]	Toggles the Beeper On or Off.
	[Esc] or [Spacebar]	Exits hotkey mode.
	[F1]	Sets Operating System to Windows
	[F2]	Sets Operating System to Mac
	[F3]	Sets Operating System to Sun
	[H]	Toggles the Hotkey invocation keys.
	[Port ID] [Enter]	Switches access to the computer that corresponds to that Port ID.
	[R] [Enter]	Administrator only hotkey. It returns the switch's settings to their default values.
	[T]	Toggles the <i>OSD Hotkey</i> between [Ctrl] [Ctrl] and [Scroll Lock] [Scroll Lock].
	[←]	Invokes Skip Mode and skips from the current port to the first accessible port previous to it.
	[→]	Invokes Skip Mode and skips from the current port to the next accessible port.
	[↑]	Invokes Skip Mode and skips from the current port to the last accessible port of the previous Station.
	[↓]	Invokes Skip Mode and skips from the current port to the first accessible port of the next Station.









# Chapter 6

## Keyboard Emulation

### Mac Keyboard

---

The PC compatible (101/104 key) keyboard can emulate the functions of the Mac keyboard. The emulation mappings are listed in the table below.

PC Keyboard	Mac Keyboard
[Shift]	Shift
[Ctrl]	Ctrl
	
[Ctrl] [1]	
[Ctrl] [2]	
[Ctrl] [3]	
[Ctrl] [4]	
[Alt]	Alt
[Print Screen]	F13
[Scroll Lock]	F14
	=
[Enter]	Return
[Backspace]	Delete
[Insert]	Help
[Ctrl] 	F15











---

**Note:** When using key combinations, press and release the first key (Ctrl), then press and release the activation key.

---

## Sun Keyboard

The PC compatible (101/104 key) keyboard can emulate the functions of the Sun keyboard when the Control key [Ctrl] is used in conjunction with other keys. The corresponding functions are shown in the table below.

PC Keyboard	Sun Keyboard
[Ctrl] [T]	Stop
[Ctrl] [F2]	Again
[Ctrl] [F3]	Props
[Ctrl] [F4]	Undo
[Ctrl] [F5]	Front
[Ctrl] [F6]	Copy
[Ctrl] [F7]	Open
[Ctrl] [F8]	Paste
[Ctrl] [F9]	Find
[Ctrl] [F10]	Cut
[Ctrl] [1]	 
[Ctrl] [2]	 
[Ctrl] [3]	 
[Ctrl] [4]	
[Ctrl] [H]	Help
	Compose
	

**Note:** When using key combinations, press and release the first key (Ctrl), then press and release the activation key.

# Chapter 7

## Logging In

### Overview

---

The KL1508Ai / KL1516Ai can be accessed via its Graphical User Interface (GUI) locally, and remotely from an Internet browser; a Windows application (AP) program; and a Java application (AP) program.

No matter which access method you choose, the KL1508Ai / KL1516Ai switch's authentication procedure requires you to submit a valid username and password. If you supply invalid login information, the authentication routine will return an *Invalid Username or Password*, or *Login Failed* message. If you see this type of message, log in again with a correct username and password.

---

**Note:** If the number of invalid login attempts exceeds a specified amount, a timeout period is invoked. You must wait until the timeout period expires before you can attempt to log in again. See *Login Failures*, page 148 for further details.

---

## Local Login

---

For instructions on logging in locally to your KL1508Ai/KL1516Ai refer to Chapter 4, *OSD Operation*.



---

## Browser Login

---

The KL1508Ai / KL1516Ai can be accessed via an Internet browser running on any platform. To access the switch, do the following:

1. Open the browser and specify the IP address of the switch you want to access in the browser's location bar.

---

**Note:** 1. For security purposes, a login string may have been set by the administrator (see page 149 for details). If so, you must include a forward slash and the login string along with the IP address when you log in. For example:

192.168.0.100/kl1516ai

2. If you don't know the IP address and login string, ask your Administrator. The KL1508Ai / KL1516Ai's default IP address is: 192.168.0.60
- 

2. When a Security *Alert* dialog box appears, accept the certificate – it can be trusted. (See *Trusted Certificates*, page 207, for details.) If a second certificate appears, accept it as well.

Once you accept the certificate(s), the login page appears:

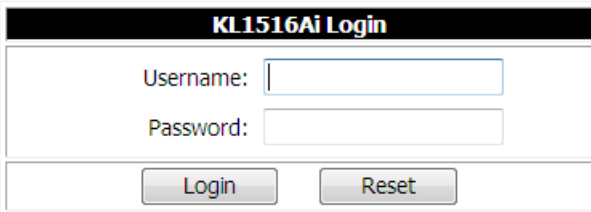

The screenshot shows a web browser window with a black title bar containing the text "KL1516Ai Login". The main content area has a white background. It features two text input fields. The first is labeled "Username:" and the second is labeled "Password:". Below these fields are two buttons: "Login" and "Reset".

3. Provide your username and password (set by the administrator), then click **Login** to bring up the Web Main Page. For a discussion of the Web Main Page, see page 77.

---

**Note:** If you are the administrator and are logging in for the first time, use the default username (*administrator*) and the default password (*password*). For security purposes, the system will prompt you to change the login password. The password must be different from your login password.

---

## Windows Client AP Login

The Windows AP Client allows direct remote access to Windows systems users, without having to go through a browser (although you initially download the Windows AP Client program from the browser page – see Chapter 14, *Download*). To connect to the KL1508Ai / KL1516Ai, go to the location on your hard disk that you downloaded the Windows AP Client program to, and double-click its icon (*WinClient.exe*).

To connect to the KL1508Ai / KL1516Ai, click the *WinClient.exe* program icon (on your desktop) to bring up the Windows Client Connection screen:

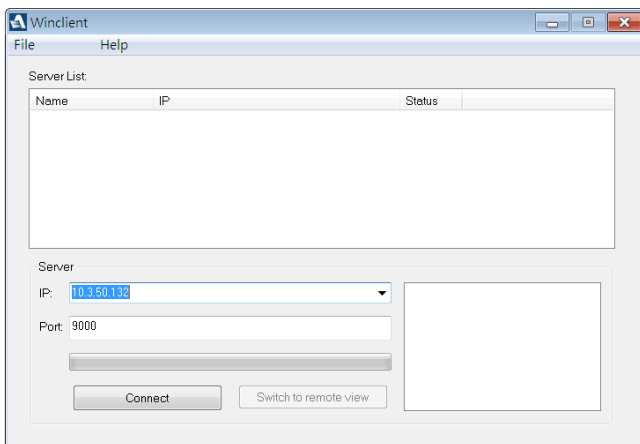

## The Windows Client AP Connection Screen

A description of the Connection Screen is given in the following table:

Item	Description
Server List	<p>Each time the WinClient.exe file is run, it searches the user's local LAN segment for KL1508Ai / KL1516Ai, and lists whichever ones it finds in this box. If you want to connect to one of these units, <b>double-click</b> it. (See <i>Connecting – Windows Client AP</i>, page 72 for details.)</p> <p><b>Note:</b></p> <ol style="list-style-type: none"> <li>1. The switch will not appear in the list unless its <i>Enable Device List</i> configuration parameter has been enabled.</li> <li>2. Only units whose Access Port settings for <i>Program</i> match the number specified for <i>Port</i> in the Server area of this dialog box appear in the Server List window.</li> </ol>
Server	<p>This area is used when you want to connect to a KL1508Ai / KL1516Ai at a remote location. You can drop down the IP list box and select an address from the list. If the address you want isn't listed, you can key in the target IP address in the IP field, and its port number in the Port field. (If you don't know the port number, contact your Administrator.)</p> <ul style="list-style-type: none"> <li>◆ When the IP address and Port number have been specified, click <b>Connect</b>. (See <i>Connecting – Windows Client AP</i>, page 72 for details.)</li> <li>◆ When you have finished with your session and come back to this dialog box, click <b>Disconnect</b> to end the connection.</li> </ul>
Message List	<p>Located just to the right of the Server panel, the Message List panel lists status messages regarding the connection to the KL1508Ai / KL1516Ai.</p>
Connect	<p>Click <b>Connect</b> after selecting a device in the Server list to login with a secure connection.</p>
Switch to Remote View	<p>Once you have been authenticated (see <i>Connecting – Windows Client AP</i>, page 72 for details), this button becomes active. Click it to switch to the GUI Main Page. The GUI Main Page is described on page 77.</p>

## **Connecting – Windows Client AP**

To connect to a KL1508Ai / KL1516Ai do the following:

1. From the *Server List* box, **double-click** the device that you wish to connect to.  
– Or –  
Specify its IP address and port number in the *Server IP* and *Port* input boxes.
2. Click **Connect**.  
The *Login* dialog box appears:

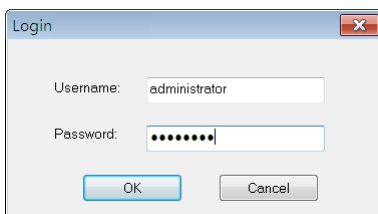

3. Key in a valid Username and Password, and then click **OK**.
4. Once you have been authenticated, the *Remote View* button becomes active:

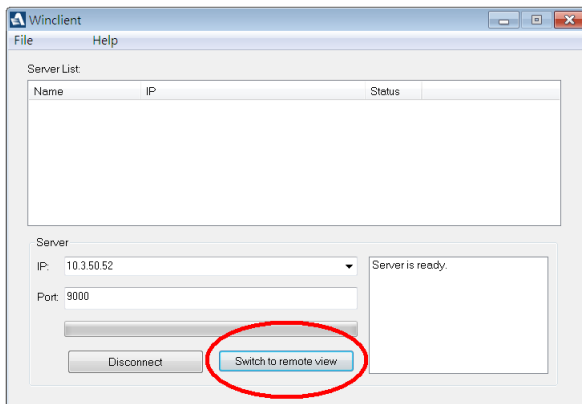

5. Click it to connect to the switch and bring up its GUI Main Page. For a description of the GUI Main Page, see page 77.

## Java Client AP Login

The Java AP Client provides direct remote access to non-Windows systems users (although you initially download the Java AP Client program from the browser page – see Chapter 14, *Download*). To connect to the KL1508Ai / KL1516Ai, go to the location on your hard disk that you downloaded the Java AP Client program to, and double-click its icon (*JavaClient.jar*).

To connect to the KL1508Ai / KL1516Ai, click the *JavaClient.jar* program icon (on your desktop) to bring up the Windows Client Connection screen:

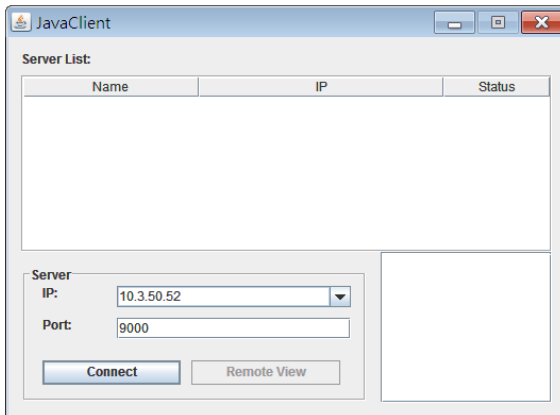

## The Java Client AP Connection Screen

A description of the Connection Screen is given in the following table:

Item	Description
Server List	<p>Each time the JavaClient.jar file is run, it searches the User's local LAN segment for KL1508Ai / KL1516Ai, and lists whichever ones it finds in this box. If you want to connect to one of these units, <b>double-click</b> it. (See <i>Connecting – Windows Client AP</i>, page 72 for details.)</p> <p><b>Note:</b></p> <ol style="list-style-type: none"> <li>1. The switch will not appear in the list unless its <i>Enable Device List</i> configuration parameter has been enabled.</li> <li>2. Only units whose Access Port settings for <i>Program</i> (see <i>Service Ports</i>, page 141) match the number specified for <i>Port</i> in the Server area of this dialog box appear in the Server List window.</li> </ol>
Server	<p>This area is used when you want to connect to a KL1508Ai / KL1516Ai at a remote location. You can drop down the IP list box and select an address from the list. If the address you want isn't listed, you can key in the target IP address in the IP field, and its port number in the Port field. (If you don't know the port number, contact your Administrator.)</p> <ul style="list-style-type: none"> <li>◆ When the IP address and Port number have been specified, click <b>Connect</b>. (See <i>Connecting – Windows Client AP</i>, page 72 for details.)</li> <li>◆ When you have finished with your session and come back to this dialog box, click <b>Disconnect</b> to end the connection.</li> </ul>
Message Panel	<p>Located just to the right of the Server panel, the Message panel lists status messages regarding the connection to the KL1508Ai / KL1516Ai.</p>
Connect	<p>Click <b>Connect</b> after selecting a device in the <i>Server</i> list to login with a secure connection.</p>
Switch to Remote View	<p>Once you have been authenticated (see <i>Connecting – Windows Client AP</i>, page 72 for details), this button becomes active. Click it to switch to the GUI Main Page. The GUI Main Page is described on page 77.</p>

## **Connecting – Java Client AP**

To connect to a KVM switch do the following:

1. From the *Server List* box, **double-click** the device that you wish to connect to.  
– Or –  
Specify its IP address and port number in the *Server IP* and *Port* input boxes.

2. Click **Login**

The *Login* dialog box appears:

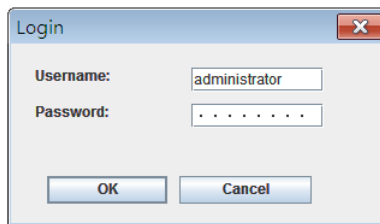

3. Key in a valid Username and Password, and then click **OK**.
4. Once you have been authenticated, the *Remote View* button becomes active:

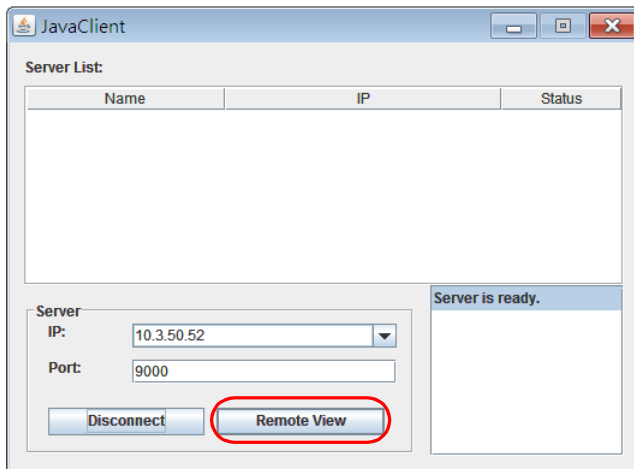

5. Click it to connect to the switch and bring up its GUI Main Page. For a description of the GUI Main Page, see page 77.

This Page Intentionally Left Blank



# Chapter 8

## The User Interface

### Overview

Once you have successfully logged in, the KL1508Ai / KL1516Ai user interface Main Page appears. The look of the page varies slightly, depending on which method you used to log in. Each of the interfaces is described in the sections that follow.

### The Web Browser Main Page

To ensure multi-platform operability, access to the KL1508Ai / KL1516Ai can be accomplished with most standard web browsers. Once users log in and are authenticated (see page 67), the *Web Browser Main Page* comes up, with the Port Access page displayed:

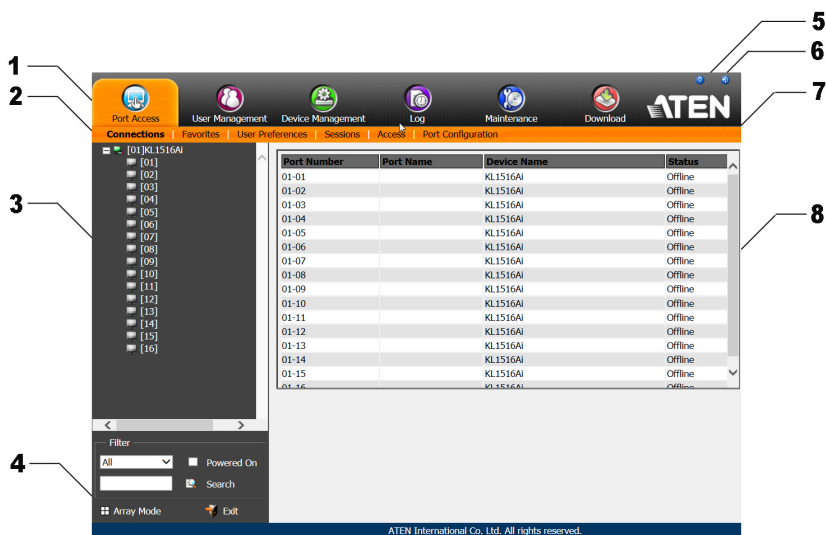

**Note:** The screen depicts an Administrator's page. Depending on a user's type and permissions, not all of these elements appear.







## Page Components

The web page screen components are described in the table below:



No.	Item	Description
1	Tab Bar	The tab bar contains the KL1508Ai / KL1516Ai main operation categories. The items that appear in the tab bar are determined by the user's type, and the authorization options that were selected when the user's account was created.
2	Menu Bar	The menu bar contains operational sub-categories that pertain to the item selected in the tab bar. The items that appear in the menu bar are determined by the user's type, and the authorization options that were selected when the user's account was created.
3	Sidebar	The Sidebar provides a tree view listing of ports that relate to the various tab bar and menu bar selections. Clicking a node in the Sidebar brings up a page with the details that are relevant to it.
4	Filter	<p>The filter section at the bottom of the Sidebar lets you expand or narrow the scope of the ports that appear in the Sidebar tree, as follows:</p> <ul style="list-style-type: none"> <li>◆ <i>All</i> – Lists all of the ports on the installation</li> <li>◆ <i>Power On</i> – Lists only the ports that have their attached devices powered on</li> <li>◆ <i>Search</i> – Lists only the ports that relate to the text typed in the search box. Enter text then click <b>Search</b>.</li> </ul>
5	Help	About provides information regarding the switch's current firmware version.
6	Logout	Click this button to log out of your KL1508Ai / KL1516Ai session.
7	Welcome Message	If this function is enabled (see <i>Welcome Message</i> , page 78), a welcome message displays here.
8	Interactive Display Panel	This is your main work area. The screens that appear reflect your menu choices and Sidebar node selection.

## The Tab Bar

The number and type of icons that appear on the Tab Bar at the top of the page are determined by the user's type (Administrator or User) and the permissions assigned when the user's account was created. The functions associated with each of the icons are explained in the table below:

Icon	Function
	<b>Port Access:</b> The Port Access page is used to access and control the devices on the KL1508Ai / KL1516Ai installation. This page is available to all users.
	<b>User Management:</b> The User Management page is used to create and manage Users and Groups. It can also be used to assign devices to them. User Management is discussed on page 129. This tab is available to the Administrator, as well as users who have been given User Management permission. The tab doesn't appear for other users.
	<b>Device Management:</b> The Device Management page is used to configure and control the overall operation of the KL1508Ai / KL1516Ai. This page is available to the Administrator, as well as users who have been given Device Management permission. The tab doesn't appear for other and users.
	<b>Log:</b> The Log page displays the contents of the log file. The Log page is discussed on page 161.
	<b>Maintenance:</b> The Maintenance page is used to install new firmware; backup and restore configuration and account information; ping network devices; and restore default values. The Maintenance page is discussed on page 163. This page is available to the Administrator and Users with <i>Maintenance</i> permission. The icon doesn't display on the page of ordinary users.
	<b>Download:</b> Users can click this icon to download AP versions of the Windows Client; the Java Client; and the Log Server. This page is available to all users. The programs that can be downloaded depend on the user's permissions.

There are two small icons at the extreme right of the page. Their functions are described in the table, below:

Icon	Function
	Click this icon to brings up a panel with information about the KVM switch firmware version.
	Click this icon to log out and end your KVM switch session.

## The AP GUI Main Page

With WinClient AP, and Java Client AP access, once users log in (see *Logging In*, page 67), the *GUI Main Page* comes up:

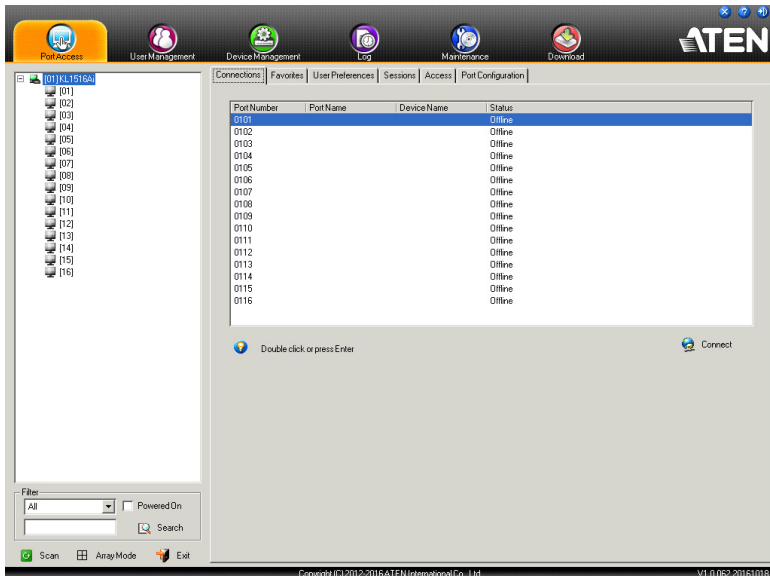

The GUI Main Page is similar to that of the Web Browser. The differences between them are as follows:

1. The AP GUI version doesn't have a menu bar below the tab bar; it has a series of tabs like a notebook, instead. Like the Web Browser interface, however, the makeup of the tabbed notebook changes depending on the items selected on the main Tab Bar and in the Sidebar.
2. There is a hidden *Control Panel* at the upper or lower center of the screen that becomes visible when you mouse over it. (The default is at the upper center of the screen.)

---

## The Control Panel

---

### WinClient Control Panel

Since the WinClient Control Panel contains the most complete functionality, this section describes the WinClient Control Panel. Although the Java Control Panel does not enable all of the features that this one does, the functions that they do share are the same, and you can refer to the information described here when using it.

The Control Panel is hidden at the upper or lower center of the screen (the default is at the lower center), and becomes visible when you mouse over it. The panel consists of three rows: an icon row at the top, and two text rows below it:



---

**Note:** The above image shows the complete Control Panel. The icons that appear can be user selected. See *Control Panel Configuration*, page 106, for details.

---

- ♦ By default, the upper text row shows the video resolution of the remote display. As the mouse pointer moves over the icons in the icon bar, however, the information in the upper text row changes to describe the icon's function. In addition, if a message from another user is entered in the message board, and you have not opened the message board in your session, the message will appear in the upper row.
- ♦ The lower row shows the IP address of the device you are accessing at the left of the row.



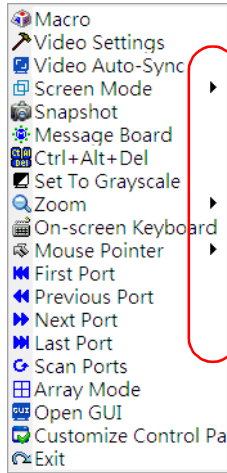









- ◆ Right clicking in the text row area brings up a menu-style version of the toolbar. In addition, it allows you to select options for the *Screen Mode*, *Zoom*, *Mouse Pointer* type, and *Mouse Pointer*. These functions are discussed in the sections that follow.













- ◆ To move the Control Panel to a different location on the screen, place the mouse pointer over the text row area, then click and drag.

## WinClient Control Panel Functions

The Control Panel functions are described in the table below.

Icon	Function
	This is a toggle. Click to make the Control Panel persistent – i.e., it always displays on top of other screen elements. Click again to have it display normally.
	Click to bring up the Macros dialog box (see page 86 for details).
	Click to bring up the Video Options dialog box. Right-click to perform a quick Auto Sync (see <i>Video Settings</i> , page 95, for details).
	Click to perform a video and mouse autosync operation. It is the same as clicking the Auto-sync button in the <i>Video Options</i> dialog box (see <i>Video Settings</i> , page 95).
	Toggles the display between <i>Full Screen Mode</i> and <i>Windowed Mode</i> .
	Click to take a snapshot (screen capture) of the remote display. See <i>Snapshot</i> , page 107, for details on configuring the Snapshot parameters.
	Click to bring up the Message Board (see <i>The Message Board</i> , page 98).
	Click to send a Ctrl+Alt+Del signal to the remote system.
	Click to toggle the remote display between color and gray scale views.
	Click to zoom the remote display window. <b>Note:</b> This feature is only available in windowed mode (Full Screen Mode is off). See <i>Zoom</i> , page 100 for details.
	Click to bring up the on-screen keyboard (see <i>The On-Screen Keyboard</i> , page 101).
	Click to select the mouse pointer type. <b>Note:</b> This icon changes depending on which mouse pointer type is selected (see <i>Mouse Pointer Type</i> , page 103).

	<p>Click to toggle Automatic or Manual mouse sync.</p> <ul style="list-style-type: none"> <li>◆ When the selection is <i>Automatic</i>, a green ✓ appears on the icon.</li> <li>◆ When the selection is <i>Manual</i>, a red X appears on the icon.</li> </ul> <p>See <i>Mouse DynaSync Mode</i>, page 104 for a complete explanation of this feature.</p>
	<p>Click to display a dropdown list of <i>User</i> macros in order to access and run macros more conveniently than using the Macros dialog box (see the <i>Macros</i> icon in the table above, and the <i>Macros</i> section on page 86).</p>
	<p>Under an accessed port, click to skip to the first port accessible to the user on the entire installation without having to recall the Port Access page.</p>
	<p>Under an accessed port, click to skip to the first port accessible to the user that is previous to the current one without having to recall the Port Access page.</p>
	<p>Under an accessed port, click to skip to the first port accessible to the user that is after the current one without having to recall the Port Access page.</p>
	<p>Under an accessed port, click to skip to the last port accessible to the user on the entire installation without having to recall the Port Access page.</p>
	<p>Under an accessed port, click to begin Auto Scan Mode. The KVM over IP switch automatically switches among the ports that were selected for Auto Scanning with the Filter function (see <i>Filter</i>, page 112). This allows you to monitor their activity without having to switch among them manually.</p>
	<p>Under an accessed port, click to invoke Panel Array Mode (See <i>Panel Array Mode</i>, page 182).</p>
	<p>Under an accessed port, click to recall the GUI.</p>
	<p>Click to bring up the Control Panel Configuration dialog box. See <i>Control Panel Configuration</i>, page 106, for details on configuring the Control Panel.</p>
	<p>Click to exit the viewer.</p> <ul style="list-style-type: none"> <li>◆ Exiting from a Browser Viewer session brings you back to the web browser Main Page.</li> <li>◆ Exiting from a WinClient AP session brings you back to the login dialog box (see page 70).</li> <li>◆ Exiting from a Java Client AP session brings you back to the login dialog box (see page 73).</li> </ul>





These icons show the Num Lock, Caps Lock, and Scroll Lock status of the remote computer.

- ◆ When the lock state is *On*, the LED is bright green and the lock hasp is closed.
- ◆ When the lock state is *Off*, the LED is dull green and the lock hasp is open.

Click on the icon to toggle the status.

**Note:** These icons and your local keyboard icons are in sync. Clicking an icon causes the corresponding LED on your keyboard to change accordingly. Likewise, pressing a Lock key on your keyboard causes the icon's color to change accordingly.



## Macros

The Macros icon provides access to three functions found in the Macros dialog box: Hotkeys, User Macros, and System Macros. Each of these functions is described in the following sections.

### Hotkeys

Various actions related to manipulating the remote server can be accomplished with hotkeys. The *Hotkey Setup* utility (accessed by clicking this icon), lets you configure which hotkeys perform the actions.

The hotkeys that invoke an action are shown to the right of its name. Use the checkbox to the left of an action's name to enable or disable its hotkey.

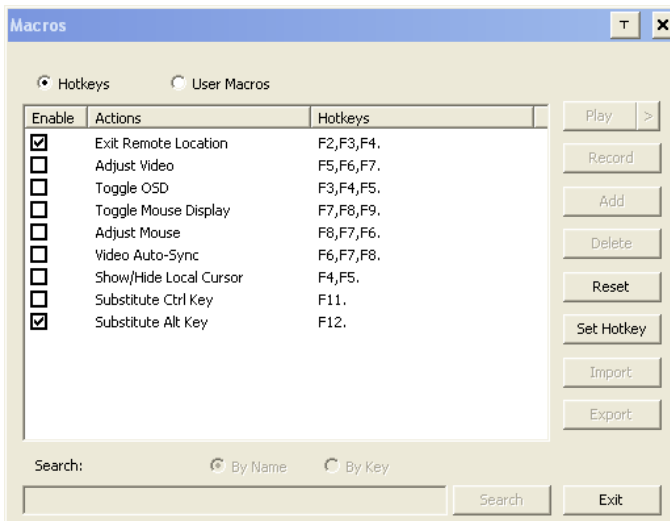

To change the hotkey for an action, do the following:

1. Highlight the *Action*, then click **Set Hotkey**.
2. Press your selected Function keys (one at a time). The key names appear in the *Hotkeys* field as you press them.
  - ◆ You can use the same function keys for more than one action, as long as the key sequence is not the same.
  - ◆ To cancel setting a hotkey value, click **Cancel**; to clear an action's Hotkeys field, click **Clear**.
3. When you have finished keying in your sequence, click **Save**.

To reset all the hotkeys to their default values, click **Reset**.

An explanation of the Hotkey actions is given in the table below:

Action	Explanation
Exit Remote Location	Breaks the connection to the KL1508Ai / KL1516Ai and returns you to local client computer operation. This is equivalent to clicking the <i>Exit</i> icon on the Control Panel. The default keys are F2, F3, F4.
Adjust Video	Brings up the <i>Video Settings</i> dialog box. This is equivalent to clicking the <i>Video Settings</i> icon on the Control Panel. The default keys are F5, F6, F7.
Toggle OSD	Toggles the OSD Control Panel Off and On. The default keys are F3, F4, F5.
Toggle Mouse Display	If you find the display of the two mouse pointers (local and remote) to be confusing or annoying, you can use this function to shrink the non-functioning pointer down to a barely noticeable tiny circle, which can be ignored. Since this function is a toggle, use the hotkeys again to bring the mouse display back to its original configuration. This is equivalent to selecting the <i>Single</i> pointer type from the <i>Mouse Pointer</i> icon on the Control Panel. The default keys are F7, F8, F9. <b>Note:</b> The Java Control Panel does not have this feature.
Adjust Mouse	This synchronizes the local and remote mouse movements. The default keys are F6, F7, F8.
Video Autosync	This combination performs an auto-sync operation. It is equivalent to clicking the <i>Video Autosync</i> icon on the Control Panel. The default keys are F8, F7, F6.
Show/Hide Local Cursor	Toggles the display of your local mouse pointer off and on. This is equivalent to selecting the <i>Null</i> pointer type from the <i>Mouse Pointer</i> icon on the Control Panel. The default keys are F4, F5.
Substitute Ctrl key	If your local client computer captures Ctrl key combinations, preventing them from being sent to the remote server, you can implement their effects on the remote server by specifying a function key to substitute for the Ctrl key. If you substitute the F11 key, for example, pressing [F11 + 5] would appear to the remote server as [Ctrl + 5]. The default key is F11.
Substitute Alt key	Although all other keyboard input is captured and sent to the KL1508Ai / KL1516Ai switch, [Alt + Tab] and [Ctrl + Alt + Del] work on your local client computer. In order to implement their effects on the remote server, another key may be substituted for the Alt key. If you substitute the F12 key, for example, you would use [F12 + Tab] and [Ctrl + F12 + Del]. The default key is F12.

## User Macros

User Macros are created to perform specific actions on the remote server. To create the macro, do the following:

1. Select *User Macros*, then click **Add**.

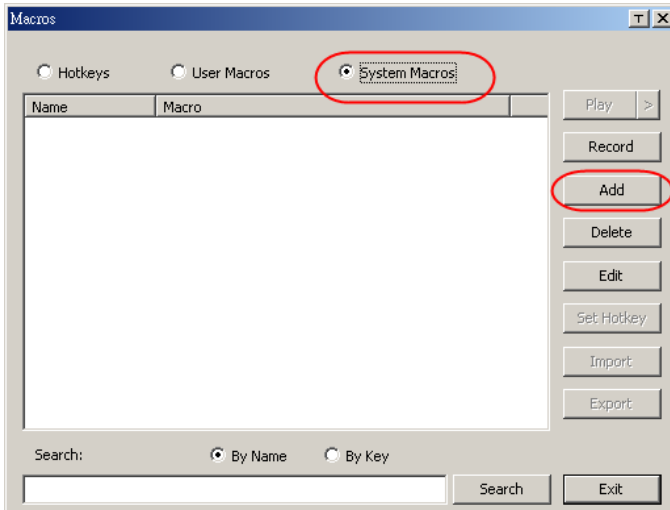

2. In the dialog box that comes up, replace the “New Macro” text with a name of your choice for the macro:

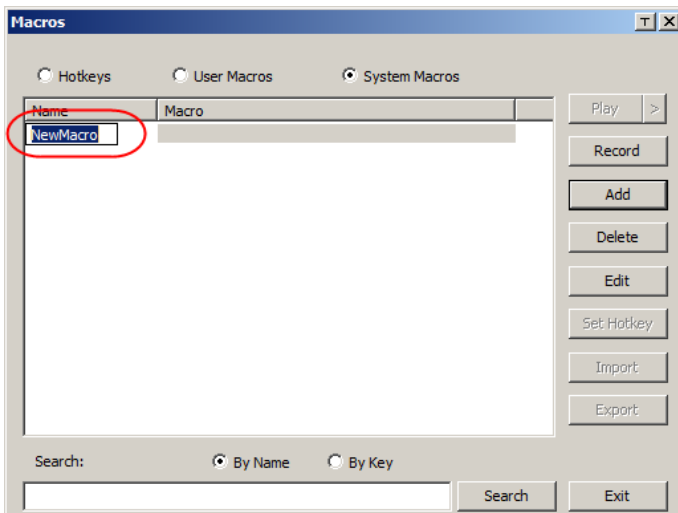

### 3. Click **Record**.

The dialog box disappears, and a small panel appears at the top left of the screen:



### 4. Press the keys for the macro.

- ◆ To pause macro recording, click **Pause**. To resume, click **Pause** again.
- ◆ Clicking **Show** brings up a dialog box that lists each keystroke that you make, together with the amount of time each one takes:

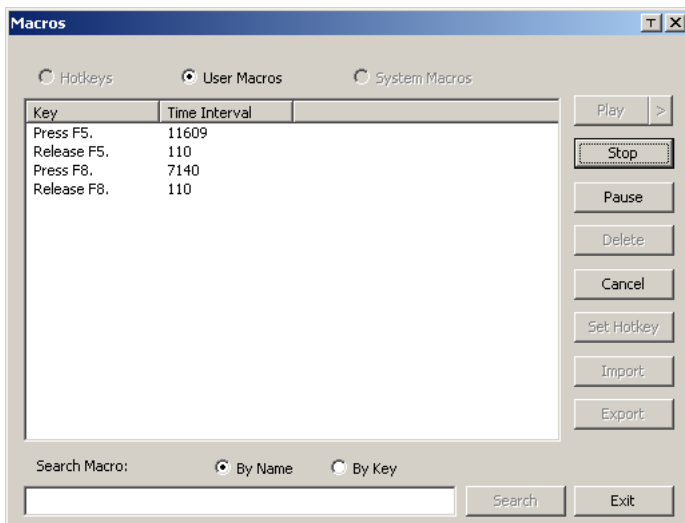

- ◆ Clicking **Cancel** cancels all keystrokes.
- ◆ When you have finished, click **Stop**. (This is the equivalent of clicking *Done* in Step 5.)

---

**Note:** 1. Case is not considered – typing **A** or **a** has the same effect.

2. When recording the macro the focus must be on the remote screen. It cannot be in the macro dialog box.
  3. Only the default keyboard characters may be used. Alternate characters cannot be used. For example, if the keyboard is Traditional Chinese and default character is **A** the alternate Chinese character obtained via keyboard switching is not recorded.
-

- If you haven't brought up the Show dialog, click **Done** when you have finished recording your macro. You return to the Macros dialog box with your macro key presses displayed in the Macro column:

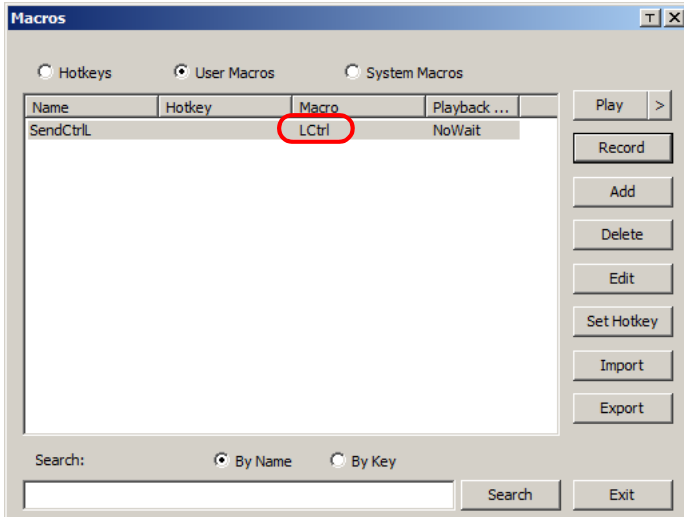

- If you want to change any of the keystrokes, select the macro and click **Edit**. This brings up a dialog box similar to the one for Show. You can change the content of your keystrokes, change their order, etc.
- Repeat the procedure for any other macros you wish to create.

After creating your macros, you can run them in any of three ways:

1. By using the hotkey (if one was assigned).
2. By opening the Macro List on the Control Panel and clicking the one you want (see page 84).
3. By opening this (Macros) dialog box and clicking **Play**.



If you run the macro from this dialog box, you have the option of specifying how the macro runs.

- ◆ If you choose *Play Without Wait*, the macro runs the key presses one after another with no time delay between them.
- ◆ If you choose *Play With Time Control*, the macro waits for the amount of time between key presses that you took when you created it. Click on the arrow next to *Play* to make your choice.
- ◆ If you click *Play* without opening the list, the macro runs with the default choice (*NoWait* or *TimeCtrl*), which is shown in the *Playback* column.

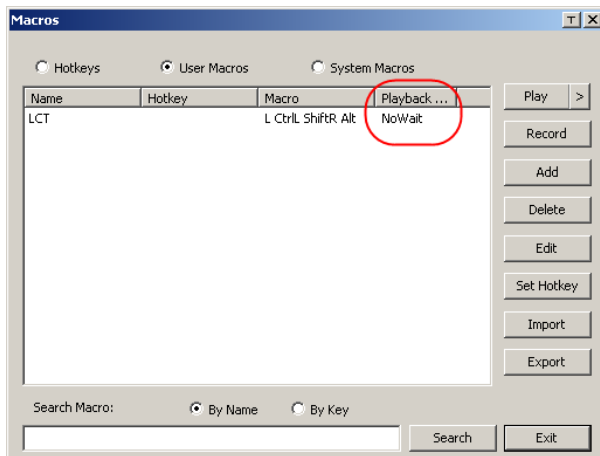

(*NoWait* in the screenshot above), and selecting the alternate choice.

**Note:** 1. Information about the Search function is given on page 92.

2. User Macros are stored on the Local Client computer of each user. Therefore, there is no limitation on the of number of macros, the size of the macro names, or makeup of the hotkey combinations that invoke them

## ■ Search

Search, at the bottom of the dialog box, lets you filter the list of macros that appear in the large upper panel for you to play or edit. Click a radio button to choose whether you want to search by name or by key; key in a string for the search; then click **Search**. All instances that match your search string appear in the upper panel.

## System Macros

System Macros are used to create exit macros for when you close a session. For example, as an added measure of security, you could create a macro that sends the Winkey-L combination which would cause the remote server's log in page to come up the next time the device was accessed. To create the macro, do the following:

1. Select *System Macros*, then click **Add**.

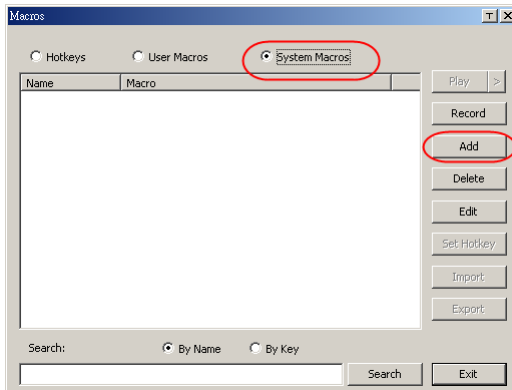

2. In the dialog box that comes up, replace the "New Macro" text with a name of your choice for the macro:

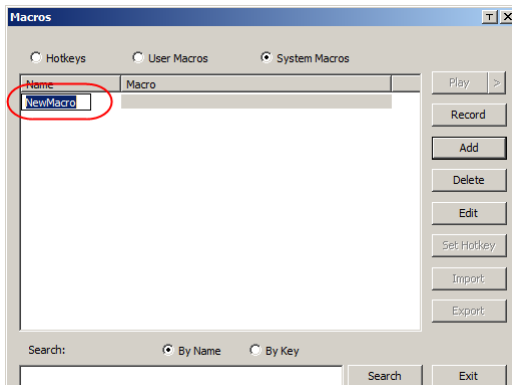



### 3. Click **Record**.

The dialog box disappears, and a small panel appears at the top left of the screen:

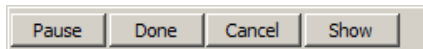

### 4. Press the keys for the macro.

- ◆ To pause macro recording, click **Pause**. To resume, click **Pause** again.
- ◆ Clicking **Show** brings up a dialog box that lists each keystroke that you make, together with the amount of time each one takes (see page 93).

---

**Note:** 1. Case is not considered – typing **A** or **a** has the same effect.

5. When recording the macro the focus must be on the remote screen. It cannot be in the macro dialog box.

2. Only the default keyboard characters may be used. Alternate characters cannot be used. For example, if the keyboard is Traditional Chinese and default character is **A** the alternate Chinese character obtained via keyboard switching is not recorded.

---

### 6. If you haven't brought up the Show dialog, click **Done** when you have finished recording your macro. You return to the Macros dialog box with your system macro key presses displayed in the Macro column:

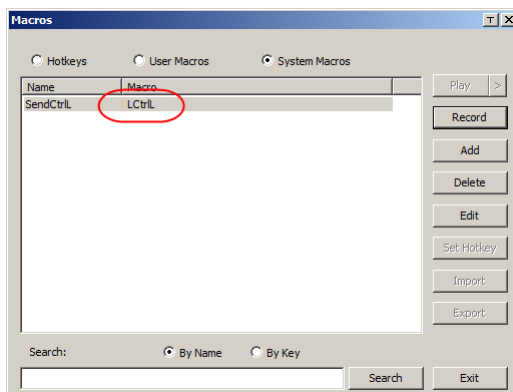

7. If you want to change any of the keystrokes, select the macro and click **Edit**. This brings up a dialog box similar to the one for Show. You can change the content of your keystrokes, change their order, etc.
8. Repeat the procedure for any other macros you wish to create.

Once the system macros have been created, they are available for use on a port-by-port basis. They get selected on a port's *Port Configuration* → *Port Properties* page (see *Port Level*, page 115 for details).

- 
- Note:**
1. Information about the Search function is given on page 92.
  2. You can choose only one system macro per port.
  3. Systems macros are stored on the switch, therefore macro names may not exceed 64 Bytes; hotkey combinations may not exceed 256 Bytes. (Each key usually takes 3–5 Bytes.)
-



## Video Settings

Clicking the *Hammer* icon on the Control Panel brings up the *Video Settings* dialog box. Click **Advanced** to view all settings. The options in this dialog box allow you to adjust the placement and picture quality of the remote screen on your monitor:

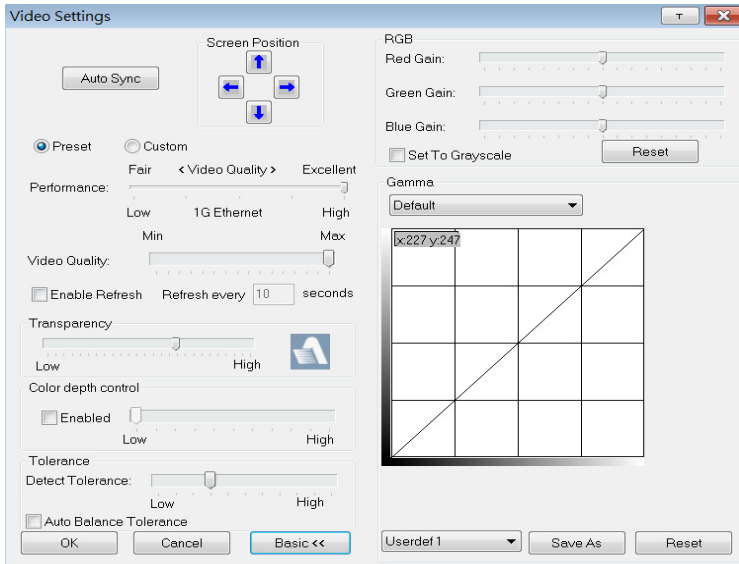

The meanings of the video adjustment options are given in the table below:

Options	Usage
Screen Position	Adjust the horizontal and vertical position of the remote server window by Clicking the Arrow buttons.
Auto-Sync	Click Auto-Sync to have the vertical and horizontal offset values of the remote screen detected and automatically synchronized with the local screen.  <b>Note:</b> 1. If the local and remote mouse pointers are out of sync, in most cases, performing this function will bring them back into sync. 2. This function works best with a bright screen. 3. If you are not satisfied with the results, use the Screen Position arrows to position the remote display manually.
RGB	Drag the slider bars to adjust the RGB (Red, Green, Blue) values. When an RGB value is increased, the RGB component of the image is correspondingly increased.  If you enable <i>Set to Grayscale</i> , the remote video display is changed to grayscale.

Options	Usage
Gamma	This section allows you to adjust the video display's gamma level. This function is discussed in detail in the next section, <i>Gamma Adjustment</i> .
Performance	<p>Drag the slide bar to adjust the bandwidth connection that the local client computer uses. The switch will use that selection to automatically adjust the <i>Video Quality</i> and <i>Detect Tolerance</i> settings to optimize the quality of the video display.</p> <p>Since network conditions vary, if none of the pre-set choices seem to work well, you can select <i>Customize</i> and use the Video Quality and Detect Tolerance slider bars to adjust the settings to suit your conditions.</p>
Video Quality	Drag the slider bar to adjust the overall Video Quality. The larger the value, the clearer the picture and the more video data goes through the network. Depending on the network bandwidth, a high value may adversely effect response time.
Enable Refresh	<p>The KL1508Ai / KL1516Ai can redraw the screen every 1 to 99 seconds, eliminating unwanted artifacts from the screen. Select <b>Enable Refresh</b> and enter a number from 1 through 99. The KL1508Ai / KL1516Ai will redraw the screen at the interval you specify. This feature is disabled by default. Click to put a check mark in the box next to <i>Enable Refresh</i> to enable this feature.</p> <p><b>Note:</b></p> <ol style="list-style-type: none"> <li>1. The switch starts counting the time interval when mouse movement stops.</li> <li>2. Enabling this feature increases the volume of video data transmitted over the network. The lower the number specified, the more often the video data is transmitted. Setting too low a value may adversely affect overall operating responsiveness.</li> </ol>
Transparency	Adjusts the transparency of the toolbar that comes up when the GUI hotkey ([Scroll Lock][Scroll Lock], for example), is invoked. Slide the bar until the display in the example window is to your liking.
Color Depth Control	This setting determines the richness of the video display by adjusting the amount of color information.
Detect Tolerance	This setting also relates to video quality. It governs detecting or ignoring pixel changes. A high setting can result in a lower quality display due to less data transfer. A lower setting will result in better video quality, but setting the threshold too low may allow too much data to be transferred, negatively impacting network performance.
Auto Balance Tolerance	Check this box to allow the system to automatically adjust the tolerance settings.

## Gamma Adjustment

If it is necessary to correct the gamma level for the remote video display, use the *Gamma* function of the Video Adjustment dialog box.

- ◆ Under *Basic* configuration, there are ten preset and four user-defined levels to choose from. Drop down the list box and choose the most suitable one.
- ◆ For greater control, clicking the *Advanced* button brings up the following dialog box:

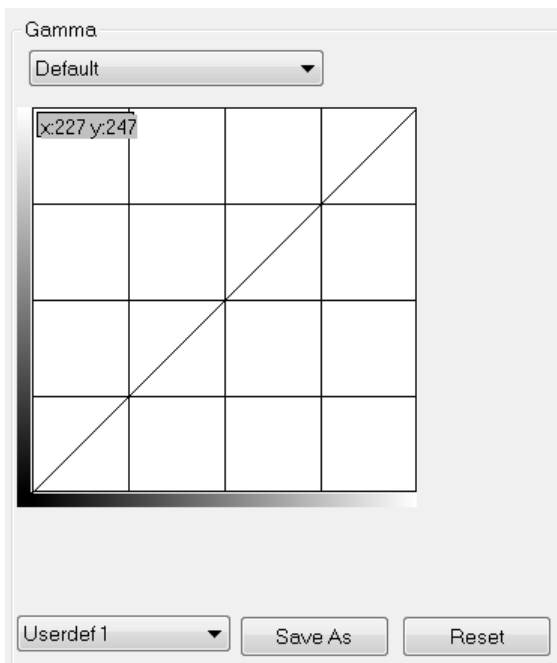

- ◆ Click and drag the diagonal line at as many points as you wish to achieve the display output you desire.
- ◆ Click **Save As** to save up to four user-defined configurations derived from this method. Saved configurations can be recalled from the list box at a future time.
- ◆ Click **Reset** to abandon any changes and return the gamma line to its original diagonal position.
- ◆ Click **OK** to save your changes and close the dialog box.
- ◆ Click **Cancel** to abandon your changes and close the dialog box.

---

**Note:** For best results, change the gamma while viewing a remote server.

---





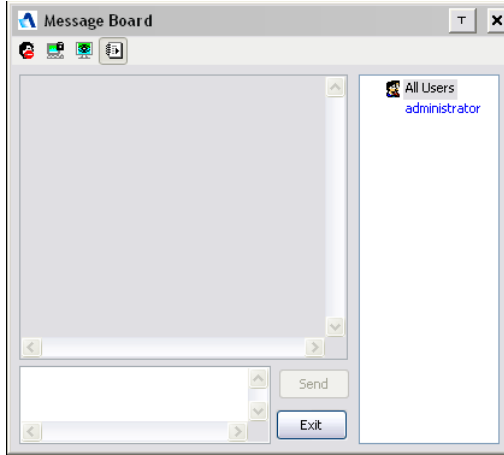

## The Message Board

The KL1508Ai / KL1516Ai supports multiple user logins, which may cause access conflicts. To alleviate the problem, a message board has been provided, which allows users to communicate with each other:



## Button Bar

The buttons on the Button Bar are toggles. Their actions are described in the table below:

Button	Action
	<b>Enable/Disable Chat.</b> When disabled, messages posted to the board are not displayed. The button is shadowed when Chat is disabled. The icon displays next to the user's name in the User List panel when the user has disabled Chat.
	<b>Occupy/Release Keyboard/Video/Mouse.</b> When you Occupy the KVM, other users cannot see the video, and cannot input keyboard or mouse data. The button is shadowed when the KVM is occupied. The icon displays next to the user's name in the User List panel when the user has occupied the KVM.
	<b>Occupy/Release Keyboard/Mouse.</b> When you Occupy the KM, other users can see the video, but cannot input keyboard or mouse data. The button is shadowed when the KM is occupied. The icon displays next to the user's name in the User List panel when the user has occupied the KM.
	<b>Show/Hide User List.</b> When you Hide the User List, the User List panel closes. The button is shadowed when the User List is open.

## Message Display Panel

Messages that users post to the board - as well as system messages - display in this panel. If you disable Chat, however, messages that get posted to the board won't appear.

## Compose Panel

Key in the messages that you want to post to the board in this panel. Click **Send**, or press [**Enter**] to post the message to the board.

## User List Panel

The names of all the logged in users are listed in this panel.

- ◆ Your name appears in blue; other users' names appear in black.
- ◆ By default, messages are posted to all users. To post a message to one individual user, select the user's name before sending your message.
- ◆ If a user's name is selected, and you want to post a message to all users, select All Users before sending your message.
- ◆ If a user has disabled Chat, its icon displays before the user's name to indicate so.
- ◆ If a user has occupied the KVM or the KM, its icon displays before the user's name to indicate so.

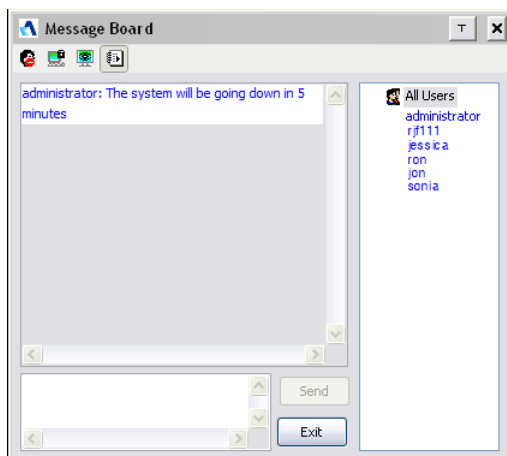



## **Zoom**

The Zoom icon controls the zoom factor for the remote view window. Settings are as follows:

<b>Setting</b>	<b>Description</b>
100%	Sizes and displays the remote view window at 100%.
75%	Sizes and displays the remote view window at 75%.
50%	Sizes and displays the remote view window at 50%.
25%	Sizes and displays the remote view window at 25%.
1:1	Sizes and displays the remote view window at 100%. The difference between this setting and the 100% setting is that when the remote view window is resized its contents don't resize – they remain at the size they were. To see any objects that are outside of the viewing area move the mouse to the window edge, to have the screen scroll.





## The On-Screen Keyboard

The KVM switch supports an on-screen keyboard, available in multiple languages, with all the standard keys for each supported language. Click this icon to pop up the on-screen keyboard:

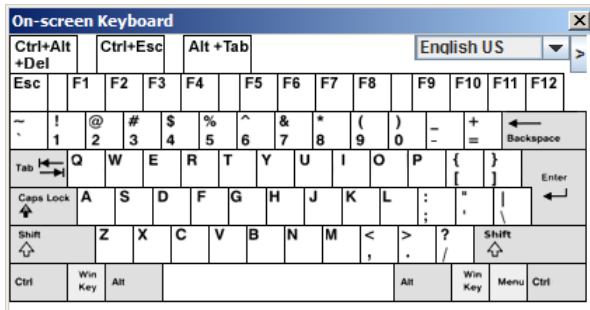

One of the major advantages of the on-screen keyboard is that if the keyboard languages of the remote and local systems aren't the same, you don't have to change the configuration settings for either system. Just bring up the on-screen keyboard; select the language used by the server you are accessing; and use the on-screen keyboard to communicate with it.

**Note:** You must use your mouse to click on the keys. You cannot use your actual keyboard.

## Changing Languages

To change languages, do the following:

1. Click the down arrow next to the currently selected language, to drop down the language list.

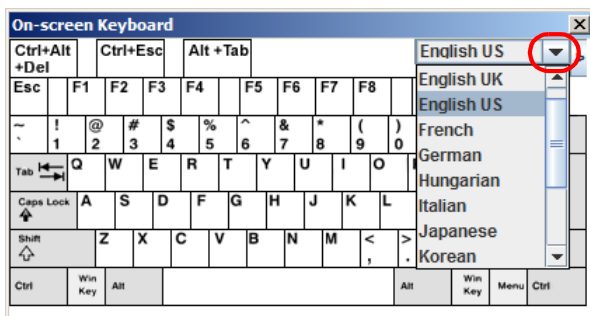

2. Select the new language from the list.

## Expanded Keyboard

To display/hide the expanded keyboard keys, click the arrow to the right of the language list arrow.

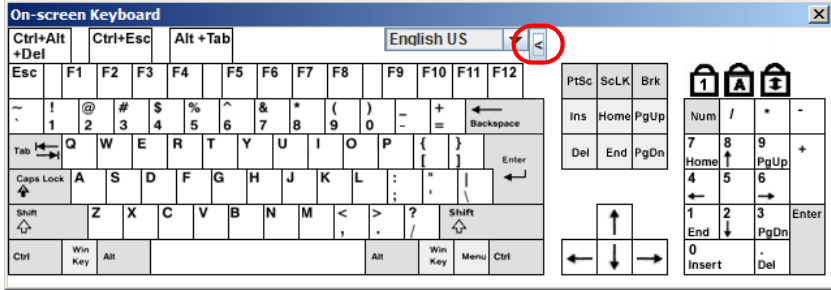



## Mouse Pointer Type

KVM switches offer a number of mouse pointer options when working in the remote display. Click this icon to select from the available choices:

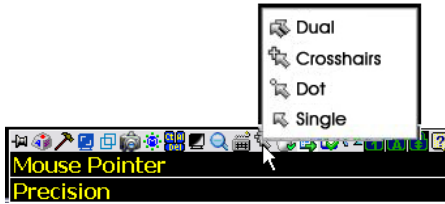

- 
- Note:**
1. Before accessing a port, only Dual and Crosshairs are available for the Windows Viewers. Once the port is accessed, all four pointers are available.
  2. The Dot pointer is not available with the Java Applet Viewer or the Java Client AP.
  3. Selecting the Dot pointer has the same effect as the *Toggle mouse display* hotkey function (see *Toggle Mouse Display*, page 87 for details).
  4. The icon on the Control Panel changes to match your choice.
-



## Mouse DynaSync Mode

Synchronization of the local and remote mouse pointers is accomplished either automatically or manually.

### Automatic Mouse Synchronization (DynaSync)

*Mouse DynaSync* provides automatic locked-in syncing of the remote and local mouse pointers – eliminating the need to constantly resync the two movements.

---

**Note:** This feature is only available for Windows and Mac systems (G4 or later) whose adapter attribute OS setting is configured for Win or Mac, which are connected to the switch with one of the following Adapter Cables: KA7170 or KA9170.

All other configurations must use manual mouse synchronization (described in the next section).

---

The icon on the Control Panel indicates the synchronization mode status as follows:

Icon	Function
	This icon displays in gray to indicate that Mouse DynaSync is not available – you must use manual syncing procedures. This is the default setting for all KVM Adapters other than the KA7170 and KA9170.
	The green check mark on this icon indicates that Mouse DynaSync is available and is <b>enabled</b> . This is the default setting when Mouse DynaSync is available. (See the Note, above.)
	The red X on this icon indicates that Mouse DynaSync is available but is <b>not enabled</b> .

When *Mouse DynaSync* is available, clicking the icon toggles its status between enabled and /disabled. If you choose to disable Mouse DynaSync mode, you must use the manual syncing procedures described under *Manual Mouse Synchronization*, page 105.

## Mac Considerations

- ◆ For Mac OS versions 10.4.11 or later, there is a second DynaSync setting to choose from. If the default Mouse DynaSync result is not satisfactory, try the **Mac 2** setting. To select Mac 2, right click in the text area of the Control Panel and select *Mouse Sync Mode* → *Automatic for Mac 2*:

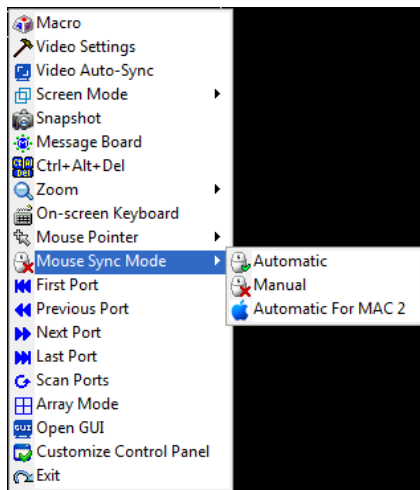

## Manual Mouse Synchronization

If the local mouse pointer goes out of sync with the remote system's mouse pointer there are a number of methods to bring them back into sync:

1. Perform a video and mouse auto sync by clicking the *Video Settings* icon on the Control Panel (see page 95).
2. Perform an *Auto Sync* with the Video Adjustment function (see *Video Settings*, page 95, for details).
3. Invoke the *Adjust Mouse* function with the *Adjust Mouse* hotkeys (see *Adjust Mouse*, page 87, for details).
4. Move the pointer into all 4 corners of the screen (in any order).
5. Drag the Control Panel to a different position on the screen.
6. Set the mouse speed and acceleration for each problematic server attached to the switch. See *Additional Mouse Synchronization Procedures*, page 219, for instructions.



## Control Panel Configuration

Clicking the *Control Panel* icon brings up a dialog box that allows you to configure the items that appear on the Control Panel, as well as its graphical settings:

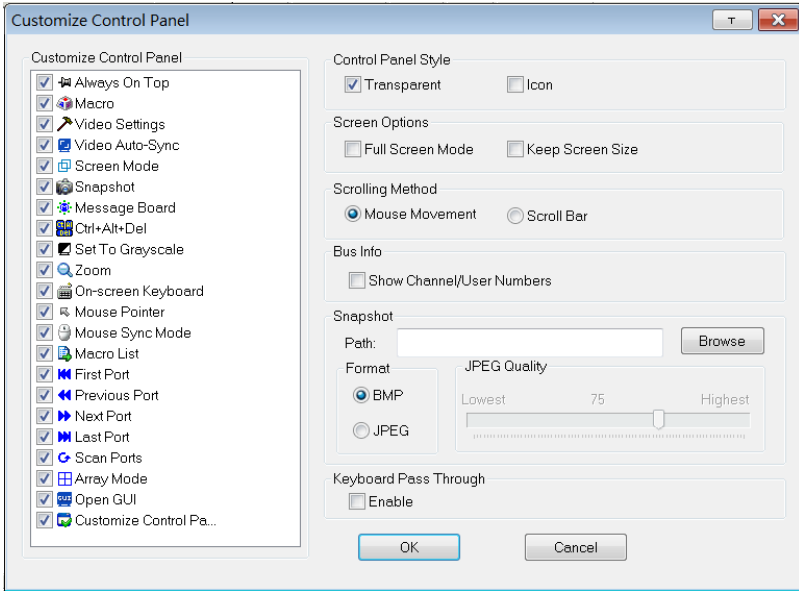

The organization of the dialog box is described in the table, below:

Item	Description
Customize Control Panel	Allows you to select which icons display in the Control Panel. Check the ones you want to see, uncheck the ones you don't want.
Control Panel Style	<ul style="list-style-type: none"> <li>Enabling <i>Transparent</i> makes the Control Panel semi-transparent, so that you can see through it to the display underneath.</li> <li>Enabling <i>Icon</i> causes the Control Panel to display as an icon until you mouse over it, when the full panel then comes up.</li> </ul>

Item	Description
Screen Options	<ul style="list-style-type: none"> <li>◆ If <i>Full Screen Mode</i> is enabled, the remote display fills the entire screen.</li> <li>◆ If <i>Full Screen Mode</i> is not enabled, the remote display appears as a window on the local desktop. If the remote screen is larger than what is able to fit in the window, move the mouse pointer to the screen border that is closest to the area you want to view and the screen will scroll.</li> <li>◆ If <i>Keep Screen Size</i> is enabled, the remote screen is not resized. <ul style="list-style-type: none"> <li>◆ If the remote resolution is smaller than that of the local monitor, its display appears like a window centered on the screen.</li> <li>◆ If the remote resolution is larger than that of the local monitor, its display is centered on the screen. To access the areas that are off screen, move the mouse to the corner of the screen that is closest to the area you want to view and the screen will scroll.</li> </ul> </li> <li>◆ If <i>Keep Screen Size</i> is not enabled, the remote screen is resized to fit the local monitor's resolution.</li> </ul>
User Info	If <i>User Info</i> is enabled, the total number of users displays on the bottom row center of the Control Panel.
Snapshot	<p>These settings let the user configure the KL1508Ai / KL1516Ai's screen capture parameters (see the <i>Snapshot</i> description under <i>The Control Panel</i>, page 81):</p> <ul style="list-style-type: none"> <li>◆ Path lets you select a directory that the captured screens automatically get saved to. Click <b>Browse</b>; navigate to the directory of your choice; then click <b>OK</b>. If you don't specify a directory here, the snapshot is saved to your desktop.</li> <li>◆ Click a radio button to choose whether you want the captured screen to be saved as a BMP or a JPEG (JPG) file.</li> <li>◆ If you choose JPEG, you can select the quality of the captured file with the slider bar. The higher the quality, the better looking the image, but the larger the file size.</li> </ul>
Keyboard Pass Through	When this is enabled, the Alt-Tab key press is passed to the remote server and affects that server. If it is not enabled, Alt-Tab acts on your local client computer.

## The Java Control Panel

The Java Client AP Control Panel is similar to the one used by the WinClient:

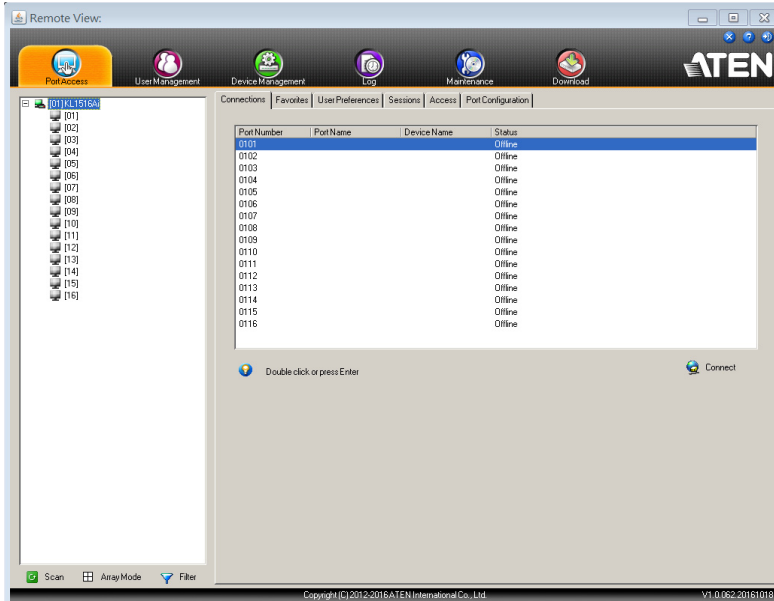

The major differences between them are:

- ◆ In the Macros dialog box, *Toggle Mouse Display* is not available.
- ◆ The *Dot* mouse pointer type is not available.
- ◆ In the Message Board, there is no *Show/Hide* button to show or hide the user list. This function is achieved by clicking the arrows at the top of the bar that separates the User List panel from the Main panel.
- ◆ The Control Panel *Lock LED* icons are not in sync with your keyboard. When you first connect, the LED display may not be accurate. To be sure, click on the LED icons to set them.
- ◆ In *Control Panel Configuration*, the BMP Snapshot format has been replaced by PNG.



# Chapter 9

## Port Access

### Overview

When you log in to the switch the *Port Access* page comes up with the KL1508Ai / KL1516Ai's KVM *Connections* page displayed.

### Browser GUI

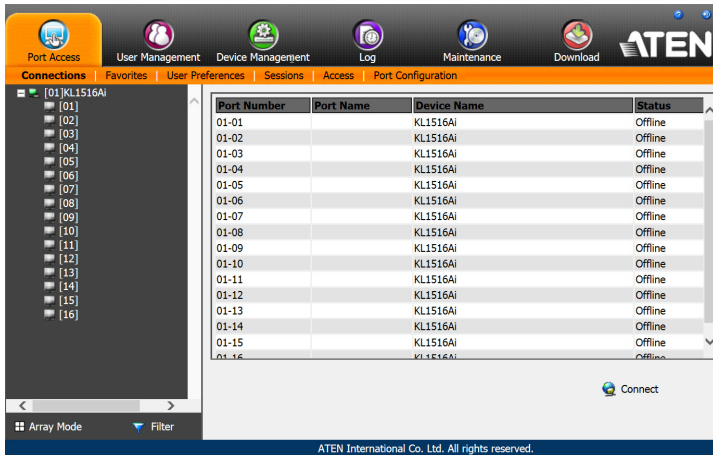

### AP GUI

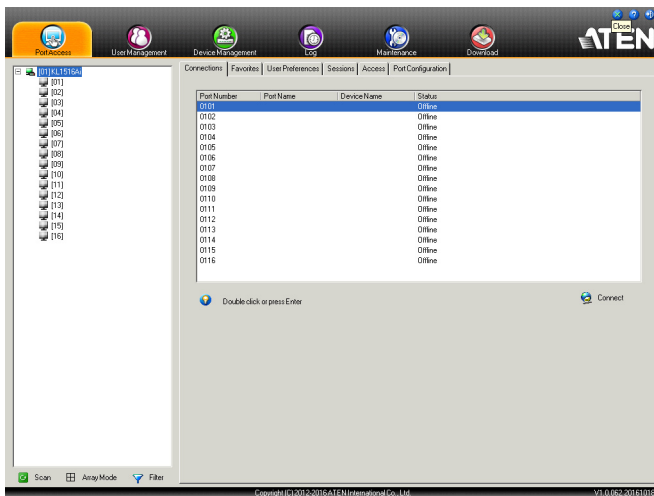

The Connections page is organized into several main areas. All the devices and ports that a user is permitted to access are listed in the Sidebar at the left of the page. After selecting a device or port in the Sidebar, clicking entries on the menu bar (Browser GUI) or tab bar (AP GUI) opens information and configuration pages related to the item selected in the Sidebar.

## The Sidebar

All KVM switches are listed in a tree structure in the Sidebar at the left of the screen:



### The Sidebar Tree Structure

- ◆ Users are only allowed to see the devices and ports that they have access permission for.
- ◆ Ports and child devices can be nested under their parent devices.  
Click the + in front of a device to expand the tree and see the ports/outlets nested underneath it. Click the - to collapse the tree and hide the nested ports/outlets.
- ◆ A port's ID number is displayed in brackets next to its icon.
- ◆ Switches and ports that are on line have their monitor screen icons in Green; the monitor screens are Gray for devices and ports that are offline.
- ◆ Outlets that are *On* have their icons in Amber; the icons are Gray for outlets that are *Off*.
- ◆ To access and operate a port, double click its icon. Port operation details are discussed in Chapter 15, *Port Operation*.

## **Scan**

Scan is found at the bottom of the AP GUI Sidebar. It automatically switches among all the ports that are visible in the Sidebar (see *Filter*, below), at regular intervals, so that their activity can be monitored automatically. See *Auto Scanning*, page 179.

---

**Note:** This item doesn't appear at the bottom of the Sidebar in the Browser version. In that version, you must invoke it from the port's Toolbar. See *The Port Toolbar*, page 177 for details.

---

## **Array Mode**

*Array* is found at the bottom of the Browser and AP GUI Sidebar. It represents another way of monitoring port activity. Under this function your screen is divided into a grid of panels, with each panel showing the video display of a particular port. Only ports that are visible in the Sidebar (see *Filter*, below), and that are online are displayed – all other ports are blank. See *Panel Array Mode*, page 182 for details.

---

**Note:** This item doesn't appear at the bottom of the Sidebar in the Browser version. In that version, you must invoke it from the port's Toolbar. See *The Port Toolbar*, page 177 for details.

---

## **Filter**

At the bottom of the sidebar are the filter options which allow you to control the number and type of ports that display in the Sidebar (also see *Scan* and *Array Mode*, above):

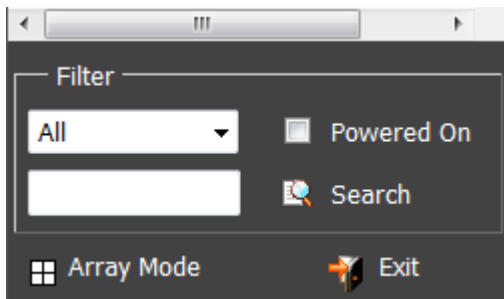

The meanings of the choices are explained in the following table:

Choices	Explanation
All	<p>This is the default view. With no other filter options selected, all of the ports that are accessible to the user are listed in the Sidebar.</p> <p>If any Favorites have been specified (See <i>Favorites</i>, page 116), you can drop down the list box and select Favorites instead of All. If you select Favorites, only the items you have selected as Favorites display in the tree.</p>
Powered On	<p>If you enable Powered On (by putting a check in the checkbox) only the ports that have their attached devices powered on display in the tree.</p>
Search	<p>If you key in a search string and click <b>Search</b>, only port names that match the search string display in the tree. Wildcards (? for single characters; * for multiple characters) and the keyword or are supported, so that more than one port can show up in the list.</p> <p>For example:</p> <ol style="list-style-type: none"> <li>1. If you key in <b>Web*</b>, both Web Server 1 and Web Server 2 show up in the list.</li> <li>2. If you key in <b>W*1 or M*2</b>, both Web Server 1 and Mail Server 2 show up in the list.</li> </ol>
Array Mode	<p>See <i>Array Mode</i>, page 112 for details.</p>
Exit	<p>Clicking <b>Exit</b> closes the filter dialog.</p>

## Connections

For the KL1508Ai / KL1516Ai, the *Connections* page displays port status information at the device level, and port connection configuration options at the port level.

### Device Level

When a KL1508Ai / KL1516Ai is selected in the Sidebar, the Connections page displays a list of ports for the device that the user is authorized to access or view.

Port Number	Port Name	Device Name	Status
01-01		KL1516Ai	Offline
01-02		KL1516Ai	Offline
01-03		KL1516Ai	Offline
01-04		KL1516Ai	Offline
01-05		KL1516Ai	Offline
01-06		KL1516Ai	Offline
01-07		KL1516Ai	Offline
01-08		KL1516Ai	Offline
01-09		KL1516Ai	Offline
01-10		KL1516Ai	Offline
01-11		KL1516Ai	Offline
01-12		KL1516Ai	Offline
01-13		KL1516Ai	Offline
01-14		KL1516Ai	Offline
01-15		KL1516Ai	Offline

 Connect

The following attributes are listed for each device:

- ◆ Port Number – the port’s number on the switch.
- ◆ Port Name – if a name has been assigned to a port it displays here.
- ◆ Device Name – if a name has been assigned to the switch it displays here.
- ◆ Status – the current status of the port – online, or offline.
- ◆ Connect – You can access any port from the main panel by selecting it and clicking **Connect**.

**Note:** The sort order of the information displayed can be changed by clicking the column headings.

## **Port Level**

When a port is selected in the Sidebar, the *Connections* page displays port connection configuration properties:

The screenshot shows a web interface for port configuration. It is divided into two main sections: 'Status' and 'Associated Link'.

**Status Section:** Displays 'Port Status: Offline' and a 'Connect' button.

**Associated Link Section:** Displays 'Link Port:' and a table with two columns: 'Port Number' and 'Port Name'. Below the table is a 'Connect' button.

Port Number	Port Name

### **Status**

The Status Panel displays the port's current status information, including whether the port is online or offline, and if the port is mountable. See *Port Configuration*, page 124, for full details about the properties and how to configure them.

Click the **Connect** button to view the port display via the KL1508Ai / KL1516Ai's built-in Win Viewer (when using Windows Internet Explorer), or Java Viewer (when using other web browsers).

### **Associated Link**

The Associated Links panel displays ports that have been associated with the currently selected port. Associations are configured on the Port Access → Port Configuration → Associated Links page (see page 122 for details).

## Favorites

The *Favorites* page is similar to a bookmarks feature. Ports that you frequently access can be saved in a list here. Simply open this page and select the port – rather than hunting for it in the Sidebar. This feature is especially handy on large, crowded installations:

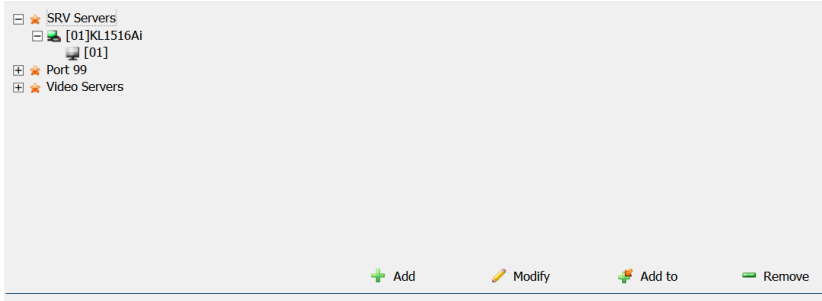

### Adding a Favorite

To add a port to the favorites, do the following:

1. Right click in the main panel; click **Add Favorite**.

– or –

Click **Add** at the bottom left of the main panel.

An *Untitled Favorite* entry appears at the bottom right corner:

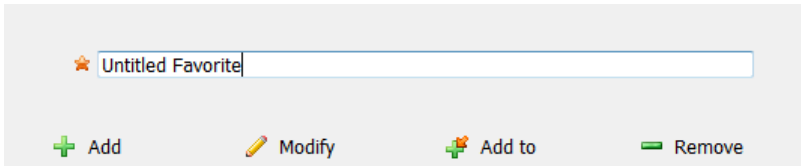

2. This will be a container to hold your port entries. Click inside the text entry box to erase *Untitled Favorite* and key in an appropriate name, then click on any empty space in the main panel.
3. To add a port, select the container in the main panel; select the port in the Sidebar; then click **Add to** at the bottom of the main panel. The switch that the port belongs to is added to the container; the selected port is appended under the switch.



---

**Note:** To add multiple ports at the same time, hold the Shift or Ctrl key down while you make your Sidebar selections then drag or copy the entire group to the Favorites panel.

---

4. Repeat step 3 for any other Favorite categories you wish to create.

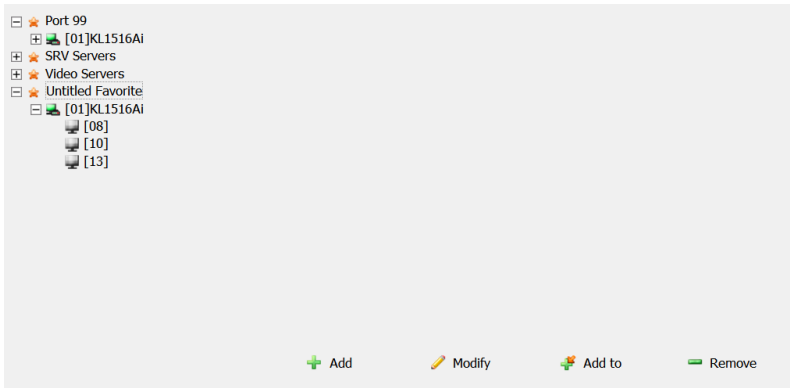

---

**Note:** Favorites can be selected for filtering in the Sidebar. See *Filter*, **page 112** for details.

---

### Modifying a Favorite

- ◆ To modify a Favorite, or one of the items contained in it, right click on it, then select a choice from the popup menu that appears.
- ◆ To edit a Favorite's name:

Click on it once, wait a second, then click again. You can edit the name after the display changes to provide a text input box.

– or –

Select the Favorite in the main panel, then click **Modify** at the bottom of the main panel.

## User Preferences

The *User Preferences* page allows users to set up their own, individual, working environments. The switch stores a separate configuration record for each user profile, and sets up the working configuration according to the *Username* that was keyed into the Login dialog box:

The screenshot shows a 'Settings' dialog box with the following fields and options:

- Language: English (dropdown)
- OSD Hotkey: [Scroll Lock] [Scroll Lock] (dropdown)
- ID Display: Port Number + Port Name (dropdown)
- ID Duration: 3 sec (text input)
- Scan Duration: 5 sec (text input)
- Screen Blanker: 0 min (text input)
- Logout Timeout: 0 min (text input)
- Toolbar:  Enable,  Disable
- Viewer:  Auto Detect,  Java Client
- Welcome Message:  Hide,  Show
- Buttons: Save (with floppy disk icon)
- Old Password: (text input)
- New Password: (text input)
- Confirm Password: (text input)
- Change Password... (with key icon)

The page settings are explained in the following table:

Setting	Function
Language	Selects the language that the interface displays in.
OSD Hotkey	Selects which Hotkey controls the OSD function: [Scroll Lock] [Scroll Lock] is the default. To select a different combination, click the arrow at the right of the box to drop down the list of choices.
ID Display	Selects how the Port ID is displayed: the Port Number alone (PORT NUMBER); the Port Name alone (PORT NAME); or the Port Number plus the Port Name (PORT NUMBER + PORT NAME). The default is PORT NUMBER + PORT NAME.
ID Duration	Determines how long a Port ID displays on the monitor after a port change has taken place. You can choose an amount from 1—255 seconds. The default is 3 Seconds. A setting of 0 (zero) means the Port ID is always on.

Setting	Function
Scan Duration	Determines how long the focus dwells on each port as it cycles through the selected ports in Auto Scan Mode (see <i>Auto Scanning</i> , page 179). Key in a value from 1—255 seconds. The default is 5 seconds; a setting of 0 disables the Scan function.
Screen Blanker	If there is no input from the console for the amount of time set with this function, the screen is blanked. Key in a value from 1—30 minutes. A setting of 0 disables this function. The default is 0 (disabled). <b>Note:</b> Although this function can be set from either the local console or a remote login, it only affects the local console monitor.
Logout Timeout	If there is no user input for the amount of time set with this function, the user is automatically logged out. A login is necessary before the KL1508Ai / KL1516Ai can be accessed again.
Toolbar	Selects whether or not the Port Toolbar is enabled when a port is accessed (see <i>The Port Toolbar</i> , page 177 for details). Since the Toolbar functions are also available from the GUI Control Panel (see <i>The Control Panel</i> , page 81), you may prefer to disable it here.
Viewer*	You can choose which viewer is used when accessing a server: <ul style="list-style-type: none"> <li>◆ <b>Auto Detect</b> will select the appropriate viewer based on the web browser used; WinClient for Windows Internet Explorer, Java Client for other web browsers (ex. Firefox).</li> <li>◆ <b>Java Client</b> will open the Java based viewer regardless of the web browser being used.</li> </ul>
Welcome Message*	You can choose to hide or show the welcome message displayed in the submenu bar. The default is disabled.
Changing a Password	<ul style="list-style-type: none"> <li>◆ In the Browser GUI, to change a user's password, key in the old password and new password into their input boxes; key the new password into the <i>Confirm</i> input box, then click <b>Change Password</b> to apply the change.</li> <li>◆ In the AP GUI version, click <b>Change Password</b>; key in the old password and new password into their input boxes; key the new password into the <i>Confirm</i> input box, then click <b>Save</b>.</li> </ul>
Save	Click <b>Save</b> to save any changes made to the User Preferences settings.



\* This item is only available with the Browser version.

## Sessions

---

The *Session* page lets the administrator and users with User Management permissions see at a glance which users are currently logged into the KL1508Ai / KL1516Ai, and provides information about each of their sessions.

Username	IP	Login Time	Client	Category	Devices	Ports	Bus ID
administrator	10.3.41.129	2018/02/27 03:32:45	Browser	SA	None		

 End Session  Refresh

- 
- Note:**
1. The Session page isn't available for ordinary users.
  2. Users with User Management permissions can only see the sessions of ordinary users.
  3. The sort order of the information displayed can be changed by clicking the column headings.
- 

The meanings of the headings at the top of the page are fairly straightforward. The *IP* heading refers to the IP address that the user has logged in from; the *Login Time* and *Client* tell you when and how the user logged in, and the *Category* heading lists the type of user who has logged in: Admin (Administrator); Normal user (User)

This page also gives the administrator the option of forcing a user logout by selecting the user and clicking **End Session** at the bottom of the main panel.

## Access

Administrators use the *Access* page to set user access and configuration rights for ports.

**Note:** The Access page only appears for those users with User Management permissions. It isn't available for other users.

### Browser GUI Interface

If a port is chosen in the Sidebar, the Main panel looks similar to the one shown below:

Name	Access	Config
administrator	✓	✓
Robert	X	X

The main panel consists of two columns: *Name*, and *Access Rights*:

- ◆ *Name* lists all the users that have been created.
- ◆ *Access Rights* indicates the users who have access rights privileges. A check mark ( ✓ ) indicates that the user has permission to make changes to the switch configuration settings (see Chapter 11, *Device Management*); an X means that the user is denied permission to make configuration changes. Click the icon to toggle permission between Full Access, View Only, and No Access.
- ◆ *Config* indicates the users who have Configuration privileges. A check mark ( ✓ ) indicates that the user has permission to make changes to the switch configuration settings (see Chapter 11, *Device Management*); an X means that the user is denied permission to make configuration changes. Click the icon to toggle permission for Administrators and Users (Super Administrators always have configuration privileges).
- ◆ The Copy and Paste buttons at the bottom of the main panel provide a shortcut method of assigning the permissions settings of one port to any of the other ports. To do so:

1. Select the port whose permissions you want the other port(s) to follow.
2. Click **Copy**.
3. Select the port you want to receive the permissions.
4. Click **Paste**.
5. When you have finished making your configuration changes, click **Save**.

## **AP GUI Interface**

The AP GUI *Access* page is similar to the Browser GUI version (see above).

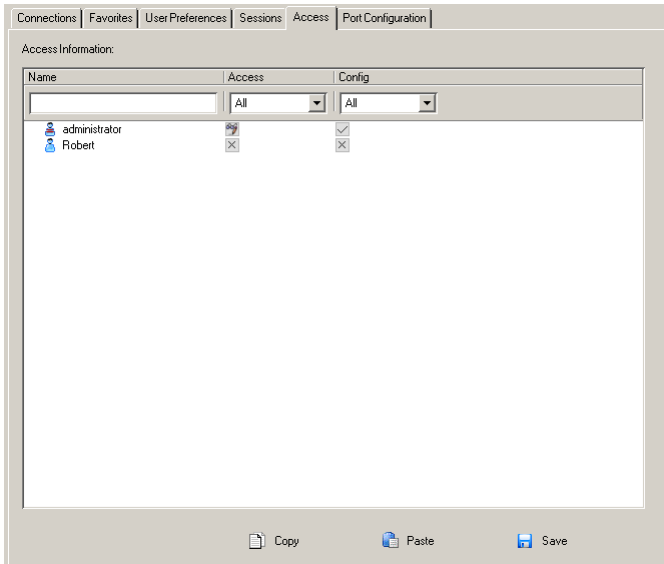

- ◆ For information on using this page, see *Access*, page 121.

## **Saving Changes**

Click the **Save** button at the lower right corner of the page to save any changes made on the *Access* page.

## Port Configuration

The Port Configuration page displays status information and allows you to set the properties of a port that has been selected in the Sidebar.

The screenshot shows a web interface for port configuration. It is divided into three main sections: Status, Properties, and Exit Macro. The Status section shows Port Status as Offline, Adapter Type as Unknown, and Adapter Version as Unknown. The Properties section contains four dropdown menus: Port OS (Win), OS Language (US English), Cable Length (Long), and Access Mode (Share). The Exit Macro section has a dropdown menu set to None. A Save button with a floppy disk icon is located at the bottom center.

Status	
Port Status:	Offline
Adapter Type:	Unknown
Adapter Version:	Unknown

Properties			
Port OS:	Win	OS Language:	US English
Cable Length:	Long	Access Mode:	Share

Exit Macro
None

 Save

- ◆ The *Status* panel provides information as to whether or not the port is online or offline; the Adapter cable used to connect the server (or other device) to the port; and the Adapter's firmware level.
- ◆ The *Properties* panel allows you to make configuration settings for the selected port. An explanation of the Port Properties configuration fields is given on the next page, please refer to the table on page 125 for further details.
- ◆ The *Exit Macro* panel contains a drop-down listbox of user created System macros. You can select a macro from the list that will execute when exiting the remote server. See *System Macros*, page 92 for details on creating exit macros.



An explanation of the configuration fields is given in the table below:

Field	Explanation
Port OS	Specifies the operating system that the server on the connected port is using. Choices are Win, Mac, Sun, and Other. The default is Win.
OS Language	Specifies the OS language being used by the server on the connected port. Drop down the list to see the available choices. The default is English US.
Cable Length	<p>Specifies the length of the Cat5e/6 cable that is used to connect the server to the port. Choices are Short (less than 10 m), Medium (10–25 m), and Long (greater than 25 m). The default is Short.</p> <p><b>Note:</b> Cable length can affect video quality. Generally speaking, shorter cables offer better quality. This setting is designed to compensate for longer or shorter cable lengths. You can experiment to find the setting that best suits your connection.</p>
Access Mode	<p>Defines how the port is to be accessed when multiple users have logged on, as follows:</p> <p><b>Exclusive:</b> The first user to switch to the port has exclusive control over the port. No other users can view the port. The <i>Timeout</i> function does not apply to ports which have this setting.</p> <p><b>Occupy:</b> The first user to switch to the port has control over the port. However, additional users may view the port's video display. If the user who controls the port is inactive for longer than the time set in the <i>Timeout</i> box, port control is transferred to the first user to move the mouse or strike the keyboard.</p> <p><b>Share:</b> Users simultaneously share control over the port. Input from the users is placed in a queue and executed chronologically. .</p>
Exit Macro	The Exit Macro panel contains a drop-down list box of user created System macros. You can select a macro from the list that will execute when exiting the remote server. See <i>System Macros</i> , page 92 for details on creating exit macros.

## Associated Link

The Associated Links page provides a method of associating other ports on the same switch to the selected port. This function is primarily intended to be used when connecting both KVM and serial ports (KA7140) from a single server to the switch.



- ◆ To associate a port with the currently selected one, click **Add**. In the dialog box that appears, key in the port's number, then click **OK**. The port's number and name appear in the main panel.
- ◆ To remove an unwanted associated port, select it in the main panel, then click **Remove**.

## Occupy Timeout

When a switch is selected in the sidebar, the *Occupy Timeout* setting appear when Port Configuration is selected on the menu bar:

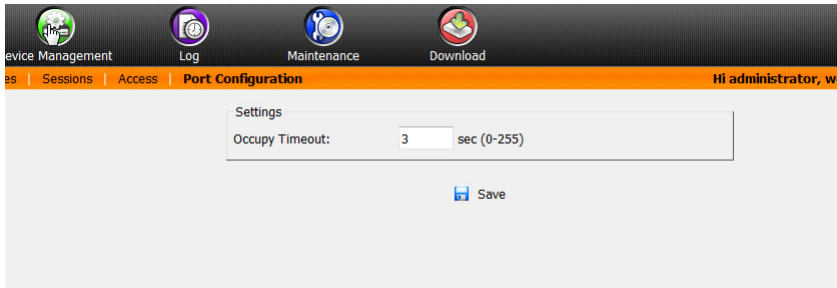

Use *Occupy Timeout Mode* to set a time threshold for users on ports whose Operation Mode has been set to Occupy (See *Port Configuration*, page 124). If there is no activity from the user occupying the port for the amount of time set here, the user is timed out and keyboard and mouse control on the port is released, after which the first user to send keyboard or mouse input will occupy the port. However, the user originally connected to the port will still see the port's video output.

Input a value from 0 to 255 seconds. The default is 3 seconds. A setting of 0 causes the port to be released the instant there is no input.

This Page Intentionally Left Blank

# Chapter 10

## User Management

### Overview

---

When you select the *User Management* tab the screen comes up with the *Users* page displayed:

### Browser GUI

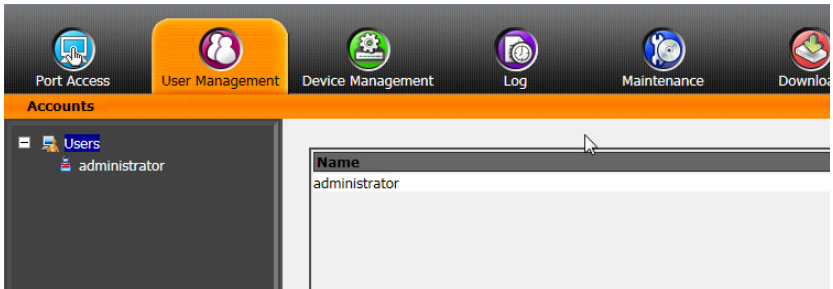

### AP GUI

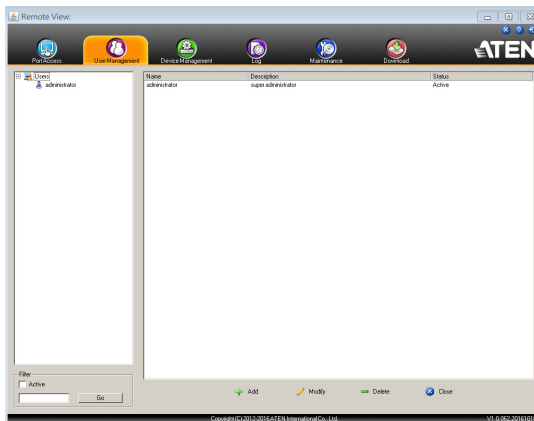

- ◆ Users appear in the panel at the left of the page. The large panel at the right provides more detailed information at-a-glance for each.
- ◆ The buttons below the main panel are used to manage users , as shown in the sections that follow.

# Users

The KL1508Ai / KL1516Ai supports three types of user accounts, as shown in the table, below:

User Type	Role
Super Administrator	Access and manage ports and devices. Manage Users. Configure the overall installation. Configure personal working environment.
Administrator	Access and manage authorized ports and devices. Manage Users. Configure personal working environment.
User	Access authorized ports and devices. Manage authorized ports and devices; configure personal working environment. <b>Note:</b> Users who have been given permission to do so, may also manage other users.

## Adding Users

To add user, and assign user permissions, do the following:

1. Select *Users* in the Sidebar (Browser GUI)
  - or –
  - Select *Users* in the Sidebar (AP GUI).
2. To add a user, click **Add** at the bottom of the main panel. The User notebook opens, with the *User* tab selected:

**User Information**

Username:

Password:

Confirm Password:

Description:

**Role**

Super Administrator   
  Administrator   
  User

**Permissions:**

Device Management   
  Port Configuration   
  User Management  
 Maintenance   
  System Log   
  View only  
 Windows Client   
  Java Client   
  Force to Grayscale  
 Power Management

**Status**

Disable account  
 Account never expires  
 Account expires on   
 User must change password at next logon  
 User cannot change password  
 Password never expires  
 Password expires after  days

3. Enter the required information in the appropriate fields. A description of each of the fields is given in the table below:

Field	Description
Username	Enter a username with a minimum of 6 and maximum of 16 characters.
Password	Enter a password with a minimum of 6 and maximum of 16 characters.
Confirm Password	To be sure there is no mistake in the password, you are asked to enter it again. The two entries must match.
Description	Additional information about the user that you may wish to include.
Role	<p>There are three categories: Super Administrator, Administrator and User. There is no limitation on the number of accounts that can be created in each category.</p> <ul style="list-style-type: none"> <li>◆ The <b>Super Administrator</b> is responsible for the overall installation configuration and maintenance; user management; and device and port assignments. The Super Administrator's permissions (see page 132) are automatically assigned by the system and cannot be altered.</li> <li>◆ The default permissions for <b>Administrators</b> include everything except Force to Grayscale, but the permissions can be altered for each Administrator by checking or unchecking any of the permissions checkboxes.</li> <li>◆ The default permissions for <b>Users</b> include the Win, Java, and SSH clients, but the permissions can be altered for each User by checking or unchecking any of the permissions checkboxes.</li> </ul> <p><b>Note:</b> Users who have been given User Management privileges cannot access or configure Groups.</p>

Field	Description
<p>Permissions</p> <p><b>Note:</b> For ordinary users, in addition to enabling <i>Device Management</i>, <i>Port Configuration</i>, and <i>Maintenance</i> permissions, the user must also be given those rights for each device and port that he will be allowed to manage. See <i>Device Assignment</i>, page 135 for details.</p>	<ul style="list-style-type: none"> <li>◆ Enabling <i>Device Management</i> allows a user to configure and control the settings for overall KL1508Ai / KL1516Ai operations (see <i>Device Management</i>, page 137).</li> <li>◆ Enabling <i>Maintenance</i> allows a user to perform all the Maintenance operations available under the Maintenance tab (see <i>Maintenance</i>, page 163).</li> <li>◆ Enabling <i>Windows Client</i> allows a user to download the Windows Client AP software, and access the KL1508Ai / KL1516Ai with it, in addition to (or instead of) the browser access method.</li> <li>◆ Enabling <i>Power Management</i> allows a user to download the PON AP to link to a Power Over the Net™ login screen. (see the ATEN website for more information about the PN series of Power Distribution Units).</li> <li>◆ Enabling <i>Port Configuration</i> allows a user to configure and control the settings for individual ports (see <i>Port Configuration</i>, page 124).</li> <li>◆ Enabling <i>System Log</i> allows a user to access the system log (see <i>Log</i>, page 161).</li> <li>◆ Enabling <i>Java Client</i> allows a user to download the Java Client AP software, and access the KL1508Ai / KL1516Ai with it, in addition to (or instead of) the browser access method.</li> <li>◆ Enabling <i>User Management</i> allows a user to create, modify, and delete user and group accounts.</li> <li>◆ Enabling <i>View Only</i> limits users to only being able to view the display of connected devices. They cannot control port access, nor can they input any keyboard or mouse signals to the devices they view.</li> <li>◆ <i>Force to Grayscale</i> forces the user's view of the remote display to be in grayscale. This can speed up I/O transfer in low bandwidth situations.</li> </ul>



Field	Description
Status	<p>Status allows you to control the user's account and access to the installation, as follows:</p> <ul style="list-style-type: none"> <li>◆ <i>Disable Account</i> lets you suspend a user's account without actually deleting it, so that it can be easily reinstated in the future.</li> <li>◆ If you don't want to limit the time scope of the account, select <i>Account never expires</i>; if you do want to limit the amount of time that the account remains in effect, select <i>Account expires on</i>, and key in the expiration date.</li> <li>◆ To require a user to change his password at the next logon, select <i>User must change password at next logon</i>. This can be used by the administrator to give the user a temporary password to log in for the first time, and then let the user set the password of his choice for future logins.</li> <li>◆ To make a password permanent, so that the user cannot change it to something else, select <i>User cannot change password</i>.</li> <li>◆ For security purposes, administrators may want users to change their passwords from time to time. <ul style="list-style-type: none"> <li>◆ If not, select <i>Password never expires</i>. This allows users to keep their current passwords for as long as they like.</li> <li>◆ If so, select <i>Password expires after</i>, and key in the number of days allowed before the password expires. Once the time is up, a new password must be set.</li> </ul> </li> </ul>

4. When your selections have been made click **Save**.
5. When the *Operation Succeeded* message appears, click **OK**.
6. Click **Users** in the Sidebar to return to the main screen. The new user appears in the Sidebar list and in the main panel, as well.
  - ◆ The Sidebar *Users* list can expand and collapse. If the list is expanded, click the minus symbol (–) next to the *Users* icon to collapse it; if it is collapsed there is a plus symbol (+) next to the icon. Click the plus symbol to expand it.
  - ◆ The icon for administrators has one red band.
  - ◆ The large main panel shows the user's name; the description that was given when the account was created; and whether the account is currently active or has been disabled.

## **Modifying User Accounts**

To modify a user account, do the following:

1. In the Sidebar *User* list, click the user's name  
– or –  
In the main panel, select the user's name
2. Click **Modify**.
3. In the *User* page that comes up, make your changes, then click **Save**.

---

**Note:** The *User* page is discussed on page 130; the *Devices* page is discussed on page 135.

---

## **Deleting User Accounts**

To delete a user account do the following:

1. In the main panel, select the user's name.
2. Click **Delete**.
3. Click **OK**.

To delete a group do the following:

## Device Assignment

When a user logs in to the KL1508Ai / KL1516Ai, the interface comes up with the Port Access page displayed. All the ports that the user is permitted to access are listed in the Sidebar at the left of the page. Access permissions for those ports and the devices connected to them are assigned on a port-by-port basis from the *User* list on the Sidebar of the User Management page.

**Note:** When a Super Administrator account is selected you will not be able to select the Devices tab since these accounts have full permissions and they can't be change.

### Assigning Device Permissions From the User's Notebook

To assign a device permissions to a user from the *User's* notebook, do the following:



1. In the Sidebar *User* list, click the user's name  
– or –  
In the main panel, select the user's name.
2. Click **Modify**.
3. In the *User* notebook that comes up, select the *Devices* tab. A screen, similar to the one below, appears:

Name	Access	Config
[-] [01]KL1516Ai	×	×
[01]	×	×
[02]	×	×
[03]	×	×
[04]	×	×
[05]	×	×
[06]	×	×
[07]	×	×
[08]	×	×
[09]	×	×
[10]	×	×
[11]	×	×
[12]	×	×
[13]	×	×
[14]	×	×
[15]	×	×
[16]	×	×

4. Make your permission settings for each port according to the information provided below:

**Name:** Each port accessible to the user is listed under the *Names* column.

**Access:** The *Access* column is where device access rights are set. Click the icon in the row that corresponds to the port you want to configure to cycle through the choices. The meanings of the icons are described in the table, below:

	Full Access	The user can view the remote screen and can perform operations on the remote server from his keyboard and monitor.
	View Only	The user can only view the remote screen and cannot perform any operations on it.
	No Access	No access rights – the Port will not show up on the User's list on the Main Screen.

5. When you have finished making your choices, click **Save**.
6. In the confirmation popup that appears, click **OK**.

---

**Note:** In any of the columns, you can use Shift-Click or Ctrl-Click to select a group of ports to configure. Clicking to cycle through the choices on any one of the selected ports causes all of them to cycle in unison.

---

# Chapter 11

## Device Management

### KVM Devices

#### Device Information

The Device Management page opens with the top level KL1508Ai / KL1516Ai selected in the Sidebar and the *Device Configuration* item selected on the menu bar:

#### Browser GUI

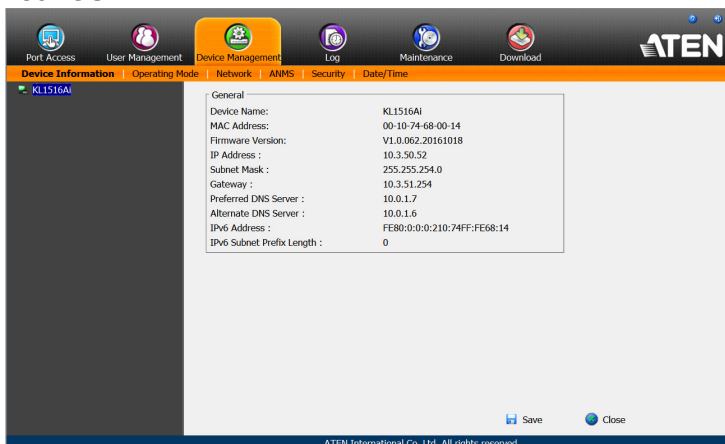

#### AP GUI

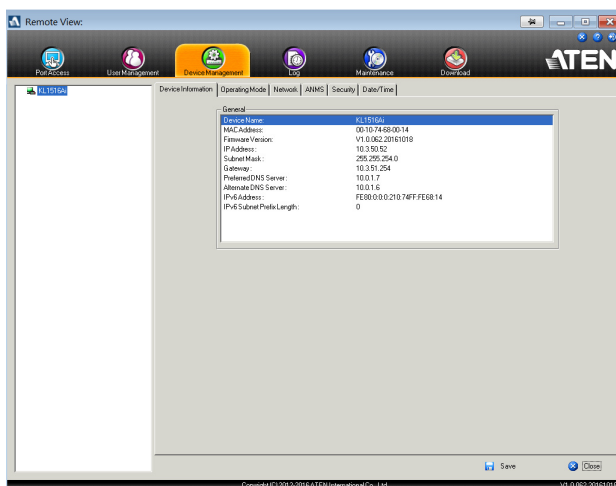

## **General**

The *General* section of the Device Management page displays the name of the selected device, its firmware version, and information about its network configuration.

---

**Note:** The AP GUI version presents the same information as the Browser version. Scroll through the list to see the additional entries.

---

## Operating Mode

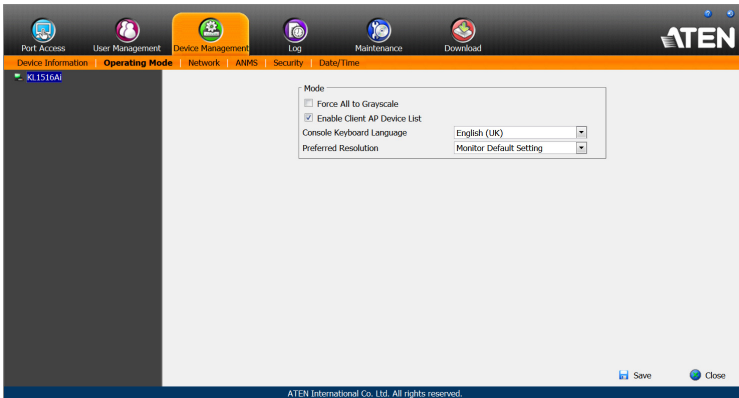

The Operating Mode page is used to set working parameters, as described below:

- ◆ If *Force all to grayscale* is enabled, the remote displays of all devices connected to the KL1508Ai / KL1516Ai are changed to grayscale. This can speed up I/O transfer in low bandwidth situations.
- ◆ If *Enable Client AP Device List* is enabled, the switch appears in the Server List when using the WinClient or Java Client AP (see *Windows Client AP Login*, page 70, and *Java Client AP Login*, page 73). If this option is not enabled, the switch can still be connected to, but its name will not appear in the Server List.
- ◆ The *Console Keyboard Language* setting lets you specify which keyboard mapping is being used by the Local Console keyboard. Drop down the list to make your choice.
- ◆ *Preferred Resolution* allows you to set a resolution that the switch sends to the KVM adapter cables. The adapter cables provide the connected computer's video card information about the monitor connected to the switch. This affects the video quality of the console monitor.
  - ◆ *Monitor Default Setting*: Sends the EDID information provided by the display connected to the console port – to the KVM adapter cable.

## Network

The Network page is used to specify the network environment.

<b>IP Installer</b>		
<input checked="" type="radio"/> Enabled	<input type="radio"/> View Only	<input type="radio"/> Disabled
<b>Service Ports</b>		
Program:	<input type="text" value="9000"/>	
HTTP:	<input type="text" value="80"/>	
HTTPS:	<input type="text" value="443"/>	
<b>IPv4 Settings</b>		
<b>IP Address:</b>		
<input checked="" type="radio"/> Obtain IP address automatically [DHCP]		
<input type="radio"/> Set IP address manually [Fixed IP]		
IP Address:	<input type="text" value="10.3.166.155"/>	
Subnet Mask:	<input type="text" value="255.255.254.0"/>	
Default Gateway:	<input type="text" value="192.168.10.30"/>	
<b>DNS Server:</b>		
<input checked="" type="radio"/> Obtain DNS server address automatically		
<input type="radio"/> Set DNS server address manually		
Preferred DNS server:	<input type="text" value="0.0.0.0"/>	
Alternate DNS server:	<input type="text" value="0.0.0.0"/>	
<b>IPv6 Settings</b>		
<b>IP Address:</b>		
<input checked="" type="radio"/> Obtain IPv6 address automatically [DHCP]		
<input type="radio"/> Set IPv6 address manually [Fixed IP]		
IPv6 Address:	<input type="text"/>	
Subnet Prefix Length:	<input type="text" value="64"/>	
Default Gateway:	<input type="text"/>	
<b>DNS Server:</b>		
<input checked="" type="radio"/> Obtain DNS server address automatically		
<input type="radio"/> Set DNS server address manually		
Preferred DNS server:	<input type="text"/>	
Alternate DNS server:	<input type="text"/>	
Network Transfer Rate:	<input type="text" value="99999"/> Kbps	

Each of the elements on this page is described in the sections that follow.



## IP Installer

The IP Installer is an external Windows-based utility for assigning IP addresses to the KL1508Ai / KL1516Ai.

Click one of the radio buttons to select *Enable*, *View Only*, or *Disable* for the IP Installer utility. See *IP Installer*, page 203, for IP Installer details.

- 
- Note:** 1. If you select *View Only*, you will be able to see the KL1508Ai / KL1516Ai in the IP Installer's Device List, but you will not be able to change the IP address.
2. For security, we strongly recommend that you set this to *View Only* or *Disable* after each use.
- 

## Service Ports

As a security measure, if a firewall is being used, the Administrator can specify the port numbers that the firewall will allow. If a port other than the default is used, users must specify the port number as part of the IP address when they log in. If an invalid port number (or no port number) is specified, the KL1508Ai / KL1516Ai will not be found. An explanation of the fields is given in the table below:

Field	Explanation
Program	This is the port number for connecting with the WinClient ActiveX Viewer, WinClient AP, Java Applet Viewer, Java Client AP, or via Virtual Media. The default is 9000.
HTTP	The port number for a browser login. The default is 80.
HTTPS	The port number for a secure browser login. The default is 443.

- 
- Note:** 1. Valid entries for all of the Service Ports are from 1–65535.
2. Service ports cannot have the same value. You must set a different value for each one.
3. If there is no firewall (on an Intranet, for example), it doesn't matter what these numbers are set to, since they have no effect.
-

## Network Configuration

- ◆ IPv4 Settings

- ◆ IP Address:

IPv4 is the traditional method of specifying IP addresses. The KVM switch can either have its IP address assigned dynamically (DHCP), or it can be given a fixed IP address.

- ◆ For dynamic IP address assignment, select the *Obtain IP address automatically* radio button. (This is the default setting.)
    - ◆ To specify a fixed IP address, select the *Set IP address manually* radio button and fill in the fields with values appropriate for your network.

---

**Note:** If the switch is on a network that uses DHCP to assign network addresses, and you need to ascertain its IP address, see *IP Address Determination*, page 203, for information./

---

- ◆ DNS Server

- ◆ For automatic DNS Server address assignment, select the *Obtain DNS Server address automatically* radio button.
  - ◆ To specify the DNS Server address manually, select the *Set DNS server address manually* radio button, and fill in the addresses for the Preferred and Alternate DNS servers with values appropriate for your network.

---

**Note:** Specifying the Alternate DNS Server address is optional.

---

- ◆ IPv6 Settings
  - ◆ IP Address:

IPv6 is the new (128-bit) format for specifying IP addresses. The KVM switch can either have its IPv6 address assigned dynamically (DHCP), or it can be given a fixed IP address.

    - ◆ For dynamic IP address assignment, select the *Obtain IP address automatically* radio button. (This is the default setting.)
    - ◆ To specify a fixed IP address, select the *Set IP address manually* radio button and fill in the fields with values appropriate for your network.
- ◆ DNS Server
  - ◆ For automatic DNS Server address assignment, select the *Obtain DNS Server address automatically* radio button.
  - ◆ To specify the DNS Server address manually, select the *Set DNS server address manually* radio button, and fill in the addresses for the Preferred and Alternate DNS servers with values appropriate for your network.

---

**Note:** Specifying the Alternate DNS Server address is optional.

---

### **Network Transfer Rate**

This setting allows you to tailor the size of the data transfer stream to match network traffic conditions by setting the rate at which the KVM over IP switch transfers data between itself and the client computers. The range is from 4–99999 Kilobytes per second (KBps).

## ANMS

The ANMS (Advanced Network Management Settings) page is used to set up login authentication and authorization management from external sources. It is organized as described, below:

### Event Destination

The screenshot shows a web interface with two tabs: "Event Destination" and "Authentication". The "Event Destination" tab is selected. Below the tabs, there is a section titled "Log Server". Inside this section, there is a checkbox labeled "Enable" which is currently unchecked. Below the checkbox are two input fields: "MAC Address" with the value "000000000000" and "Service Port" with the value "9001".

#### ◆ Log Server

When *Enable Log Server* is checked, important transactions that occur on the KL1508Ai / KL1516Ai, such as logins and internal status messages, are kept in an automatically generated log file.

- ◆ Specify the MAC address of the computer that the Log Server runs on in the *MAC address* field.
- ◆ Specify the service port used by the computer that the Log Server runs on to listen for log details in the *Port* field. The valid port range is 1–65535. The default port number is 9001.

---

**Note:** The port number must be different than the one used for the *Program* port (see *Program*, page 141).

---

See Chapter 16, *The Log Server*, for details on setting up the log server. The Log File is discussed on page 161.

## Authentication and Authorization

- ◆ RADIUS Settings

RADIUS Settings

Enable

Preferred RADIUS Server IP:

Preferred RADIUS Service Port:

Alternate RADIUS Server IP:

Alternate RADIUS Service Port:

Timeout:  sec

Retries:

Shared Secret (at least 6 characters):

To allow authentication and authorization for the KL1508Ai / KL1516Ai through a RADIUS server, do the following:

1. Check **Enable**.
2. Fill in the IP addresses and service port numbers for the Preferred and Alternate RADIUS servers. You can use the IPv4 address, the IPv6 address or the domain name in the IP fields.
3. In the *Timeout* field, set the time in seconds that the KL1508Ai / KL1516Ai waits for a RADIUS server reply before it times out.
4. In the *Retries* field, set the number of allowed RADIUS retries.
5. In the *Shared Secret* field, key in the character string that you want to use for authentication between the KL1508Ai / KL1516Ai and the RADIUS Server. A minimum of 6 characters is required.

*(Continues on next page.)*

*(Continued from previous page.)*

6. On the RADIUS server, Users can be authenticated with any of the following methods:

- ◆ Set the entry for the user as **su/xxxx**
  - ◆ Where *xxxx* represents the Username given to the user when the account was created on the KL1508Ai / KL1516Ai.
  - ◆ Use the same Username on both the RADIUS server and the KL1508Ai / KL1516Ai.
- ◆ LDAP / LDAPS Authentication and Authorization Settings

**AD/LDAP Settings**

Enable

Type

LDAP     LDAPS

LDAP Server:

Admin DN:

Admin Name:

Password:

Search DN:

Port:

Timeout:  sec

**CC Management**

Enable

CC Server IP:

CC Service Port:

*(Continues on next page.)*

To allow authentication and authorization for the KL1508Ai / KL1516Ai via LDAP / LDAPS, refer to the information in the table, below:

Item	Action
Enable	Put a check in the <i>Enable</i> checkbox to allow LDAP / LDAPS authentication and authorization.
Type	Click a radio button to specify whether to use LDAP or LDAPS.
LDAP Server IP and Port	Fill in the IP address and port number for the LDAP or LDAPS server. <ul style="list-style-type: none"> <li>◆ You can use the IPv4 address, the IPv6 address or the domain name in the <i>LDAP Server</i> field.</li> <li>◆ For LDAP, the default port number is 389; for LDAPS, the default port number is 636.</li> </ul>
Timeout	Set the time in seconds that the KL1508Ai / KL1516Ai waits for an LDAP or LDAPS server reply before it times out.
Admin DN	Consult the LDAP / LDAPS administrator to ascertain the appropriate entry for this field. For example, the entry might look like this: ou=kl1516ai,dc=aten,dc=com
Admin Name	Key in the LDAP administrator's username.
Password	Key in the LDAP administrator's password.
Search DN	Set the distinguished name of the search base. This is the domain name where the search starts for user names.

On the LDAP / LDAPS server, Users can be authenticated with the following method:

- ◆ With MS Active Directory schema.

## CC Management

To allow authorization for the KL1508Ai / KL1516Ai through a CC (Control Center) server, check *Enable* and fill in the CC Server's IP address and Service port in the appropriate fields. You can use the IPv4 address, the IPv6 address or the domain name in the *CC Server IP* field.

## Security

The Security page is divided into six main panels, as described in the sections that follow.

### Login Failures

For increased security, the Login Failures section allows administrators to set policies governing what happens when a user fails to log in successfully.

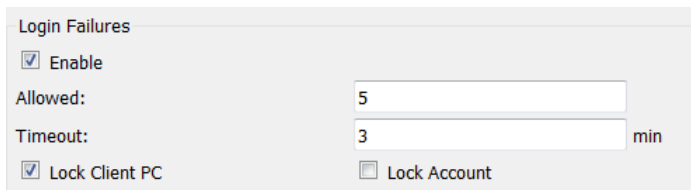

Login Failures  
 Enable  
 Allowed:   
 Timeout:  min  
 Lock Client PC       Lock Account

To set the Login Failures policy, check the *Enable* checkbox (the default is for Login Failures to be enabled). The meanings of the entries are explained in the table below:

Entry	Explanation
Allowed	Sets the number of consecutive failed login attempts that are permitted from a remote computer. The default is 5 times.
Timeout	Sets the amount of time a remote computer must wait before attempting to login again after it has exceeded the number of allowed failures. The default is 3 minutes.
Lock Client PC	If this is enabled, after the allowed number of failures have been exceeded, the computer attempting to log in from that IP is automatically locked out. No logins from that computer will be accepted. The default is enabled. <b>Note:</b> If the IP is changed, the computer will no longer be locked out.
Lock Account	If this is enabled, after the allowed number of failures have been exceeded, the user attempting to log in is automatically locked out. No logins from the username and password that have failed will be accepted. The default is enabled.

**Note:** If Login Failures is not enabled, users can attempt to log in an unlimited number of times with no restrictions. For security purposes, we recommend that you enable this function and enable the lockout policies.



## Filter

The screenshot shows a configuration window titled "Filter". It is divided into two main sections: "IP Filter" and "MAC Filter".

- IP Filter Section:**
  - Checkbox:  Enable IP Filter
  - Radio buttons:  Include,  Exclude
  - List box: An empty list box with a vertical scrollbar.
  - Buttons: Add, Modify, Delete
- MAC Filter Section:**
  - Checkbox:  Enable MAC Filter
  - Radio buttons:  Include,  Exclude
  - List box: An empty list box with a vertical scrollbar.
  - Buttons: Add, Modify, Delete
- Other Elements:**
  - Label: Login String:
  - Text input field: An empty text box.

### ◆ IP and MAC Filtering

IP and MAC Filters control access to the KL1508Ai / KL1516Ai based on the IP and/or MAC addresses of the client computers attempting to connect. A maximum of 100 IP filters and 100 MAC filters are allowed. If any filters have been configured, they appear in the IP Filter and/or MAC Filter list boxes.

To enable IP and/or MAC filtering, **Click** to put a check mark in the *IP Filter Enable* and/or *MAC Filter Enable* checkbox.

- ◆ If the include button is checked, all the addresses within the filter range are allowed access; all other addresses are denied access.
- ◆ If the exclude button is checked, all the addresses within the filter range are denied access; all other addresses are allowed access.

- ◆ Adding Filters

To add an IP filter, do the following:

1. Click **Add**. A script prompt dialog box appears.
2. Specify whether you are filtering an IPv4 or IPv6 address.
3. Key the address you want to filter in the *From*: field.
  - ◆ To filter a single IP address, click to put a check in the *Single IP* checkbox.
  - ◆ To filter a continuous range of addresses, key in the end number of the range in the *To*: field.

---

**Note:** This description is for the AP GUI. The Browser GUI differs as follows:

1. It doesn't offer an IPv4 or IPv6 choice. It only has *From* and *To* fields for IPv4 filtering.
2. It doesn't have a checkbox to specify a single IP address. To filter a single IPv4 address, key the same address in both the *From* and *To* fields.

- 
4. After filling in the address, click **OK**.
  5. Repeat these steps for any additional IP addresses you want to filter.

To add a MAC filter, do the following:

1. Click **Add**. A script prompt dialog box.
2. Specify the MAC address in the dialog box, then click **OK**.
3. Repeat these steps for any additional MAC addresses you want to filter.

◆ IP Filter / MAC Filter Conflict

If there is a conflict between an IP filter and a MAC filter – in other words, if a computer’s address is allowed by one filter but blocked by the other – then the blocking filter takes precedence (the computer’s access is blocked).

◆ Modifying Filters

To modify a filter, select it in the IP Filter or MAC Filter list boxes and click **Modify**. The Modify dialog box is similar to the Add dialog box. When it comes up, simply delete the old address(es) and replace it with the new one(s).

◆ Deleting Filters

To delete a filter, select it in the IP Filter or MAC Filter list box and click **Delete**.

## Login String

The *Login String* entry field lets the super administrator specify a login string (in addition to the IP address) that users must add to the IP address when they access the KL1508Ai / KL1516Ai with a browser.

For example, if *192.168.0.126* were the IP address, and *abcdefg* were the login string, then the user would have to key in:

```
192.168.0.126/abcdefg
```

- 
- Note:**
1. Users must place a forward slash between the IP address and the string.
  2. If no login string is specified here, anyone will be able to access the KL1508Ai / KL1516Ai login page using the IP address alone. This makes your installation less secure.
- 

The following characters are allowed in the string:

```
0-9 a-z A-Z ~ ! @ $ & * ( ) _ - = + [ ] , . |
```

The following characters are not allowed:

```
% ^ " : / ? # \ ' { } ; ' < > [Space]
```

Compound characters (É Ç ñ ... etc.)

The following examples are not allowed:

```
192.168.0.126/.
```

```
192.168.0.126/..
```

```
192.168.0.126/...
```

For security purposes, we recommend that you change this string occasionally.

## Account Policy

In the *Account Policy* section, administrators can set policies governing usernames and passwords.

Account Policy

Minimum Username Length:

Minimum Password Length:

Password Must Contain At Least

One Upper Case

One Lower Case

One Number

Enforce Password History

The meanings of the Account Policy entries are explained in the table below:

Entry	Explanation
Minimum Username Length	Sets the minimum number of characters required for a username. Acceptable values are from 1–16. The default is 6.
Minimum Password Length	Sets the minimum number of characters required for a password. Acceptable values are from 0–16. A setting of 0 means that no password is required. Users can login with only a Username. The default is 6.
Password Must Contain At Least	Checking any of these items requires users to include at least one uppercase letter, one lowercase letter or one number in their password. <b>Note:</b> This policy only affects user accounts created after this policy has been enabled, and password changes to existing user accounts. Users accounts created before this policy was enabled, and there is no change to the existing passwords, are not affected.
Enforce Password History	Checking this box will require users to create a unique password that does not match the last x passwords they've used prior. X equals the number entered in the dialog box.

## Encryption

Encryption

Keyboard/Mouse

DES     3DES     AES     RC4     Random

Video

DES     3DES     AES     RC4     Random

These flexible encryption alternatives for keyboard/mouse and video let you choose any combination of DES; 3DES; AES; RC4; or a Random cycle of any or all of them.

Enabling encryption affects system performance – no encryption offers the best performance; the greater the encryption the greater the adverse effect. If you enable encryption, the performance considerations are as follows:

- ◆ RC4 offers the least impact on performance; DES is next; then 3DES or AES
- ◆ The RC4 + DES combination offers the least impact of any combination

## Mode

Mode

Enable ICMP

Enable Multiuser Operation

Browser Service :

An explanation of the Mode items is given in the table, below:

Item	Explanation
Enable ICMP	If <i>ICMP</i> is <b>enabled</b> , the KL1508Ai / KL1516Ai can be pinged. If it is not enabled, the device cannot be pinged. The default is Enabled.
Enable Multiuser Operation	Enabling <i>Multiuser operation</i> permits up to 32 users to log in at the same time to share the remote bus. If not enabled, only one user can log in at a time. The default is Enabled.

---

Item	Explanation
Enable Browser	<p data-bbox="339 164 968 236">Enabling Browser Service allows the administrator to restrict browser access to the KVM over IP switch. After checking Browser Service, drop down the listbox to select the degree of restriction:</p> <p data-bbox="339 244 891 268"><b>Disable Browser:</b> means no browser access is permitted.</p> <p data-bbox="339 276 968 323"><b>Disable HTTP:</b> means browser access is permitted, but users must access the switch with an HTTPS URL.</p> <p data-bbox="339 331 940 379"><b>Disable HTTPS:</b> means browser access is permitted, but users must access the switch with an HTTP URL.</p>

---

## Private Certificate

When logging in over a secure (SSL) connection, a signed certificate is used to verify that the user is logging in to the intended site. For enhanced security, the *Private Certificate* section allows you to use your own private encryption key and signed certificate, rather than the default ATEN certificate.

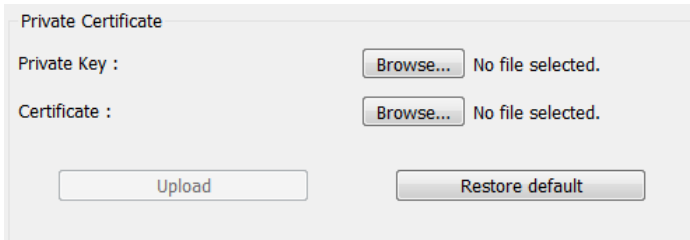

Private Certificate

Private Key :  No file selected.

Certificate :  No file selected.

There are two methods for establishing your private certificate: generating a self-signed certificate; and importing a third-party certificate authority (CA) signed certificate.

- ◆ **Generating a Self-Signed Certificate**

If you wish to create your own self-signed certificate, a free utility – openssl.exe – is available for download over the web. See *Self-Signed Private Certificates*, page 210 for details about using OpenSSL to generate your own private key and SSL certificate.

- ◆ **Obtaining a CA Signed SSL Server Certificate**

For the greatest security, we recommend using a third party certificate authority (CA) signed certificate. To obtain a third party signed certificate, go to a CA (Certificate Authority) website to apply for an SSL certificate. After the CA sends you the certificate and private encryption key, save them to a convenient location on your computer.

- ◆ **Importing the Private Certificate**

To import the private certificate, do the following:

1. Click **Browse** to the right of *Private Key*; browse to where your private encryption key file is located; and select it.
2. Click **Browse** to the right of *Certificate*; browse to where your certificate file is located; and select it.
3. Click **Upload** to complete the procedure.

---

**Note:** 1. Clicking **Restore Default** returns the device to using the default ATEN certificate.



- Both the private encryption key and the signed certificate must be imported at the same time.

## Certificate Signing Request

The Certificate Signing Request (CSR) section provides an automated way of obtaining and installing a CA signed SSL server certificate.

To perform this operation do the following:

- Click Create CSR. The following dialog box appears:

- Fill in the form – with entries that are valid for your site – according to the example information in the following table:

Information	Example
Country (2 letter code)	TW
State or Providence	Taiwan
Locality	Taipei
Organization	Your Company, Ltd.

---

Information	Example
Common Name	mycompany.com <b>Note:</b> This must be the exact domain name of the site that you want the certificate to be valid for. If the site's domain name is www.mycompany.com, and you only specify mycompany.com, the certificate will not be valid.
E-mail Address	administrator@yourcompany.com

---

3. After filling in the form (all fields are required), click **Create**.

A self-signed certificate based on the information you just provided is now stored on the KVM over IP switch.

4. Click **Get CSR**, and save the certificate file (csr.cer) to a convenient location on your computer.

This is the file that you give to the third party CA to apply for their signed SSL certificate.

5. After the CA sends you the certificate, save it to a convenient location on your computer. Click **Browse** to locate the file; then click **Upload** to store it on the KVM over IP switch.

---

**Note:** When you upload the file, the KVM over IP switch checks the file to make sure the specified information still matches. If it does, the file is accepted; if not, it is rejected.

---

If you want to remove the certificate (to replace it with a new one because of a domain name change, for example), simply click **Remove CSR**.

## Date/Time

The Date/Time dialog page sets the KL1508Ai / KL1516Ai time parameters. Set the parameters according to the information below.

**Time Zone**

(GMT-12:00) Eniwetok Kwajalein ▾

Daylight Savings Time

**Date**

February ▾ < 2018 >

February 2018

Su	Mo	Tu	We	Th	Fr	Sa
				1	2	3
4	5	6	7	8	9	10
11	12	13	14	15	16	17
18	19	20	21	22	23	24
25	26	27	28			

**Time**

10 : 02 : 08 Set

**Network Time**

Enable auto adjustment

Preferred time server

AU | ntp1.cs.mu.OZ.AU ▾

Preferred custom server IP

Alternate time server

AU | ntp1.cs.mu.OZ.AU ▾

Alternate custom server IP

Adjust time every  days Adjust Time Now

## Time Zone

- ◆ To establish the time zone that the KL1508Ai / KL1516Ai is located in, drop down the *Time Zone* list and choose the city that most closely corresponds to where it is at.
- ◆ If Daylight Savings Time (Summer Time) is currently in effect, check the corresponding checkbox. After the period of Daylight Savings Time ends (Winter Time), the checkbox should be unchecked.

## Date

- ◆ Select the month from the dropdown listbox.
- ◆ Click < or > to move backward or forward by one year increments.
- ◆ In the calendar, click on the day.
- ◆ To set the time, use the 24 hour HH:MM:SS format.
- ◆ Click **Set** to save your settings.

## Time

To manually set the time, enter the values in the boxes and click **Set**.

## Network Time

To have the time automatically synchronized to a network time server, do the following:

1. Check the *Enable auto adjustment* checkbox.
2. Drop down the time server list to select your preferred time server  
– or –  
Check the *Preferred custom server IP* checkbox, and key in either the IPv4 address, IPv6 address, or domain name of the time server of your choice.
3. If you want to configure an alternate time server, check the *Alternate time server* checkbox, and repeat step 2 for the alternate time server entries.
4. Key in your choice for the number of days between synchronization procedures.
5. If you want to synchronize immediately, click **Adjust Time Now**.

# Chapter 12 Log

## Overview

The KL1508Ai / KL1516Ai logs all the events that take place on it. To view the contents of the log, click the *Log* tab. The device's Log Information page, similar to the one below, appears:

## Browser GUI

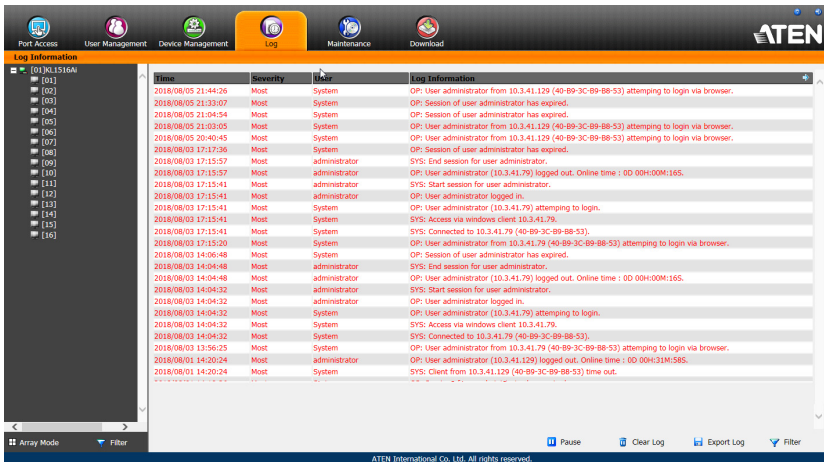

## AP GUI

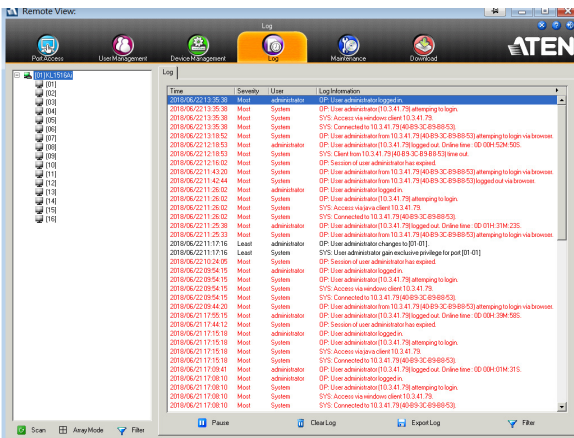

## Log Information

---

The Log page displays events that take place on the KL1508Ai / KL1516Ai, and provides a breakdown of the time, the user, and a description of each one. You can change the sort order of the display by clicking on the column headings.

The log file tracks a maximum of 512 events. When the limit is reached, the oldest events get discarded as new events come in.

# Chapter 13 Maintenance

## Overview

---

The *Maintenance* function is used to upgrade firmware; backup and restore configuration and account information; and restore default values.

## Browser GUI

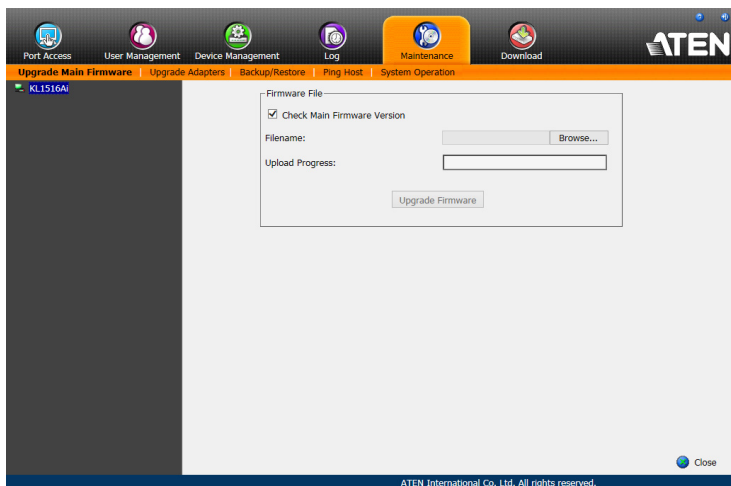

## AP GUI

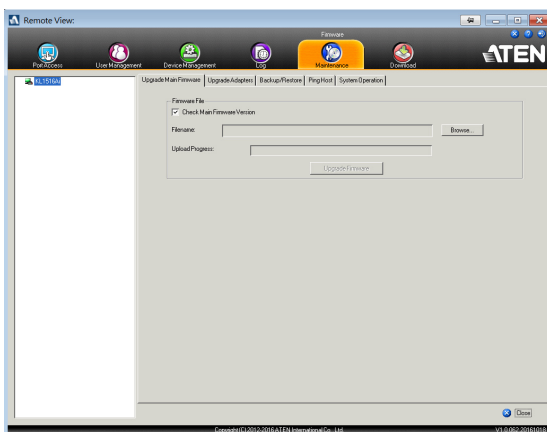

## Device IP Card Firmware Upgrade

---

As new versions of the firmware become available, they can be downloaded from our website. Check the website regularly to find the latest information and packages.

To upgrade the device firmware, do the following:

1. Download the latest IP card firmware to your computer.
2. Log in to the KL1508Ai / KL1516Ai; and click the *Maintenance* tab. The Maintenance tab opens to the *Firmware File* page:

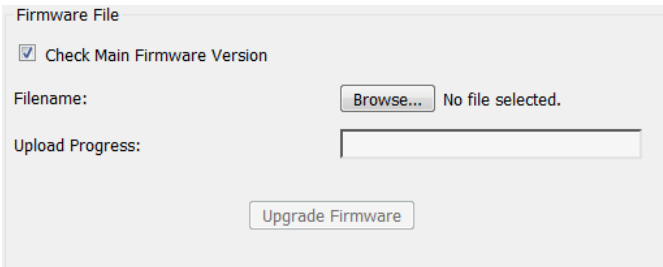

The screenshot shows a web interface titled "Firmware File". It contains a checked checkbox labeled "Check Main Firmware Version". Below this is a "Filename:" label followed by a "Browse..." button and the text "No file selected.". Underneath is an "Upload Progress:" label followed by an empty progress bar. At the bottom center is a button labeled "Upgrade Firmware".

3. Click **Browse**; navigate to the directory that the new IP card firmware file is in and select the file.
4. Click **Upgrade Firmware** to start the upgrade procedure.
  - ◆ If you enabled *Check Main Firmware Version*, the current firmware version is compared with that of the upgrade file. If the current version is equal to or higher than the upgrade version, a popup message appears to inform and stops the upgrade procedure.
  - ◆ If you didn't enable *Check Main Firmware Version*, the upgrade file is installed without checking what its version is.
  - ◆ As the upgrade proceeds, progress information is shown in the *Progress bar*.
  - ◆ Once the upgrade completes successfully, the switch resets itself.
5. Log in again, and check the firmware version to be sure it is the new one.

---

**Note:** To recover from a “failed upgrade” situation, see *Recovering from Failed Firmware Upgrade*, page 168.

---



## Mainboard and KVM Adapter Cable Firmware Upgrade

The *Upgrade Adapters* page is used to upgrade the firmware of the Stations / KVM adapter cables. **Station** in this section refers to the mainboard firmware of a KVM switch.

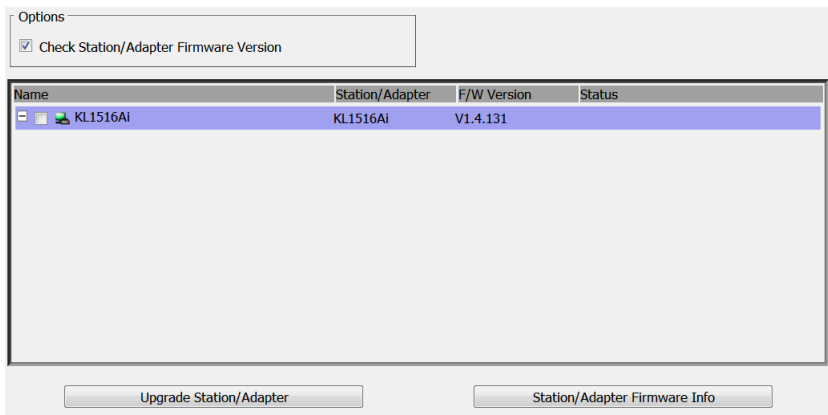

### Mainboard Firmware Upgrade

To perform this upgrade, do the following:

1. Log in to the KL1508Ai / KL1516Ai; and click the *Maintenance* tab; and select the *Upgrade Adapter* menu item.

---

**Note:** The mainboard firmware package contain software for device mainboards as well as KVM adapter cables.

---

2. The *Adapter Firmware* info button will now display a list of the mainboard firmware and adapter version that are stored in current device IP card.
3. Compare the mainboard firmware version stored in the firmware package with the version listed in the *Current F/W Version* column of the Main Panel. If the version stored in the new firmware package are newer than the one on the mainboard, you will probably want to perform the upgrade.
4. In the *Name* column of the Main Panel, check the port whose device you want to upgrade. Here you can select whether to upgrade the firmware for just the mainboard (top checkbox), just the KVM adapter cables (bottom checkbox), or both.

5. Click **Upgrade** to start the upgrade procedure.
  - ◆ When the procedure completes the new adapter firmware version is displayed.

## **KVM Adapter Cable Firmware Upgrade**

To perform this upgrade, do the following:

1. Log in to the KL1508Ai / KL1516Ai; and click the *Maintenance* tab; and select the *Upgrade Adapter* menu item.

---

**Note:** The mainboard firmware package contain software for device mainboards as well as KVM adapter cables.

---

2. The *Adapter Firmware* info button will now display a list of the mainboard firmware and adapter version that are stored in current device IP card.
3. Compare the adapter firmware version stored in the main firmware with the version listed in the *Current F/W Version* column of the Main Panel. If the version stored in the new firmware package are newer than the one on the adapter, you will probably want to perform the adapter upgrade.
4. In the *Name* column of the Main Panel, check the port whose device you want to upgrade. Here you can select whether to upgrade the firmware for just the mainboard (top checkbox), just the KVM adapter cables (bottom checkbox), or both.
5. Click **Upgrade** to start the upgrade procedure.
  - ◆ When the procedure completes the new adapter firmware version is displayed.

---

**Note:** 1. The switch may work with older adapter firmware versions, but for optimum compatibility we recommend upgrading your KVM adapter cable firmware to that stored in the switch's latest mainboard firmware package.

2. You can perform the upgrade procedure anytime you add an KVM adapter cable to the installation to make sure it is working with the latest firmware version.
  3. To recover from a "failed upgrade" situation, see *Recovering from Failed Firmware Upgrade*, page 168.
-

## Station/Adapter Firmware Info

The *Station/Adapter Firmware Info* button provides a list of the Adapter Cable firmware stored on the switch's Main firmware. You can use this information to compare it to the *F/W Version* listed for the connected Adapter Cables. For optimum compatibility we recommend upgrading your Adapter Cable's firmware to match that stored with the switch's Main firmware.

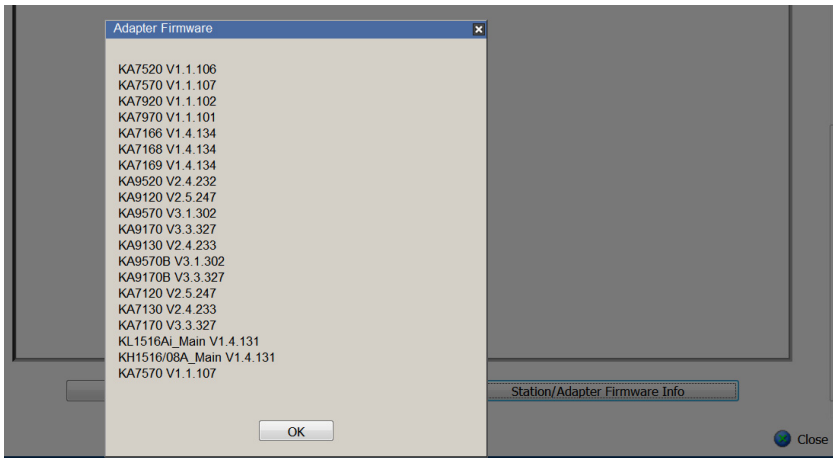

## **Recovering from Failed Firmware Upgrade**

---

### **Station (mainboard) and Adapter Firmware**

Should the adapter firmware upgrade procedure fail for one of the KVM Adapter Cables and the adapter becomes unusable, follow the steps below to resolve the problem:

1. Unplug the Adapter from the server it is connected to.
2. Slide its *Firmware Upgrade Switch* (located next to the Cat 5e connector) to the **RECOVER** position.
3. Plug the Adapter back into the server.
4. Repeat the Adapter upgrade procedure.
5. After the Adapter has been successfully upgraded, unplug the Adapter from the server it is connected to; slide the firmware upgrade switch back to the **NORMAL** position; and plug the Adapter back in.

## Backup/Restore

---

Selecting the Backup/Restore menu item gives you the ability to back up the switch's configuration and user profile information:

Backup

Password:

Backup

Restore

Filename:  No file selected.

Password:

Select All  User Account  User Select

Options

<input checked="" type="checkbox"/> Account	<input checked="" type="checkbox"/> Network
<input checked="" type="checkbox"/> ANMS	<input checked="" type="checkbox"/> Security
<input checked="" type="checkbox"/> Date/Time	<input checked="" type="checkbox"/> Operating Mode

Restore

### Backup

To backup the device's settings do the following:

1. In the *Password* field, key in a password for the file.

---

**Note:** 1. Setting a password is optional. If you do not set one, the file can be restored without specifying a password.

2. If you do set a password, make a note of it, since you will need it to be able to restore the file.
- 

2. Click **Backup**.
3. When the browser asks what you want to do with the file, select *Save to disk*; then save it in a convenient location.

## **Restore**

To restore a previous backup, do the following:

1. Click **Browse**; navigate to the file and select it.

---

**Note:** If you renamed the file, you can leave the new name. There is no need to return it to its original name.

---

2. If you set a password when you created the file, key it in the *Password* field.
3. Select as many of the options that are presented as you wish to restore.
4. Click **Restore**.

After the file is restored, a message appears to inform you that the procedure succeeded.

## Ping Host

The *Ping Host* page allows you to ping a device's IP address by entering the hostname or IP address, and view or configure options. After entering commands, the window displays the results as shown below:

The screenshot shows a window titled "Ping Host". At the top, there is a text input field labeled "IP address/Host Name" containing the text "tc help". To the right of this field is a button labeled "Ping". Below the input field is a section titled "Result" which contains a text area with the following output:

```
enablerc4 [options]
  0 - disable RC4 cipher.
  1 - enable RC4 cipher.
enablesslv2 [options]
  0 - disable SSLv2 protocol.
  1 - enable SSLv2 protocol.
get
```

Use the table below to enter *Commands* in the box and click **Ping** to run the command.

Type	Function	Command
Help	Lists the available commands	tc help
Get Status	Lists the current configuration for all options	tc get
SSLv2	Show current SSLV2 configuration	tc enablesslv2
	Disable SSLv2	tc enablesslv2 0
	Enable SSLv2	tc enablesslv2 1
RC4 Cipher	Show current RC4 cipher configuration	tc enablerc4
	Disable RC4 cipher	tc enablerc4 0
	Enable RC4 cipher	tc enablerc4 1
SSL Cipher	Show current SSL Cipher configuration	tc setsslcipher
	Use LOW, MEDIUM and HIGH ciphers	tc setsslcipher 0
	Use MEDIUM and HIGH ciphers	tc setsslcipher 1
	Use HIGH ciphers only	tc setsslcipher 2

## System Operation

---

The *System Operation* page lets you restore certain configuration changes that were made to the KL1508Ai / KL1516Ai back to their original factory default values.

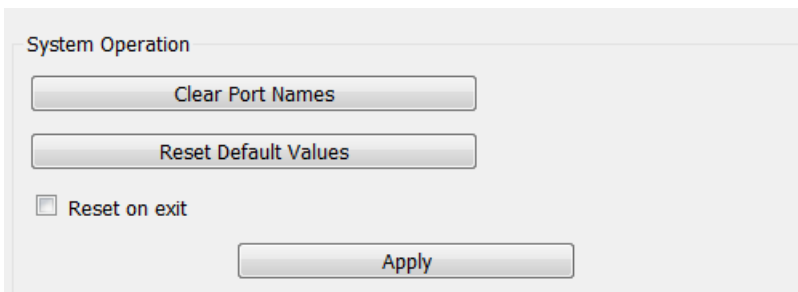

The screenshot shows a window titled "System Operation". Inside the window, there are three buttons: "Clear Port Names", "Reset Default Values", and "Apply". Below the "Reset Default Values" button is a checkbox labeled "Reset on exit".

The functions performed on this page are as follows:

### **Clear Port Names:**

Clicking this button removes names that have been assigned to the ports

### **Reset Default Values:**

Clicking this button undoes all Customization page changes that have been made to the KL1508Ai / KL1516Ai (except for the Port Names), as well as the Network Transfer Rate (on the Network page), and returns the parameters to the original factory default settings.

### **Apply:**

Clicking this button makes the KL1508Ai / KL1516Ai reset itself and implement all the new settings when you log out. (Following the reset, wait approximately 30 to 60 seconds before logging back in.)

---

**Note:** Even though the changed IP settings are ignored, they still remain in the network settings fields. Which means that the next time you open this page the *Reset on exit* checkbox will automatically be enabled, and when the switch resets, the new IP settings that you thought you discarded will become the ones used by the switch. To avoid this problem, you should go back to the network settings page and be sure that the IP settings that appear in the fields are the ones you want to use.

---



# Chapter 14

## Download

### Overview

---

*Download* is used to download stand-alone AP versions of the Windows Client, the Java Client, the Log Server, and the PON AP:

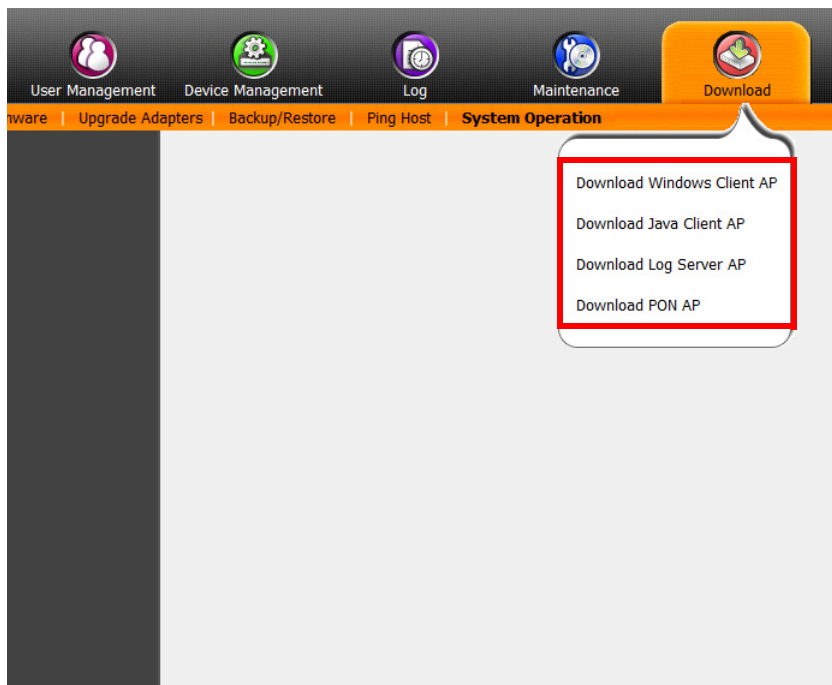

Click the **Download** tab to select the program you want to download; save it to a convenient location on your hard disk, and run it from there.

This Page Intentionally Left Blank

# Chapter 15

## Port Operation

### Overview

---

After you have successfully logged in (see *Logging In*, page 67), the KL1508Ai / KL1516Ai opens to the Port Access tab's Connections page, with the first KL1508Ai / KL1516Ai selected in the sidebar:

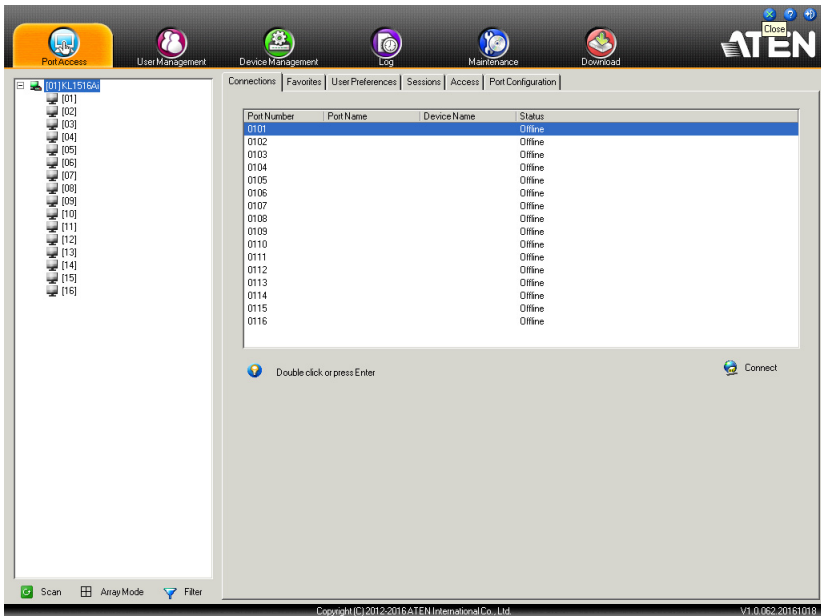

---

**Note:** See *Connections*, page 114 for details about the Port Access *Connections* page.

---

## Connecting to a Port

---

All the devices, ports, and outlets that a user is permitted to access are listed in the Sidebar at the left of the page.

- ◆ To connect to a port when a device is selected in the Sidebar, double click its icon in the Sidebar; or double click anywhere on its line entry in the main central panel; or select it in the main panel and click **Connect** at the bottom right of the page.
- ◆ To connect to a port when the port is selected in the Sidebar, click **Connect** at the right of the *Status* panel (see page 114).

Once you switch to a port, its screen displays on your monitor, and your keyboard and mouse input affects the remote server:

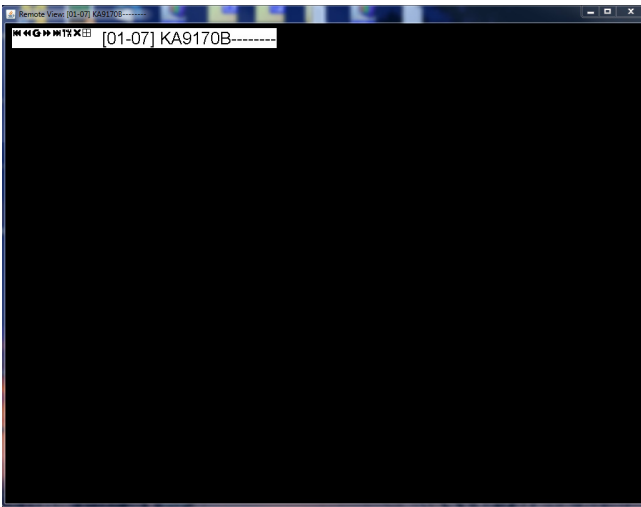

---

## The Port Toolbar

---

The KL1508Ai / KL1516Ai interface provides a toolbar to help you with port switching operations from within the captured port. To bring up the toolbar, tap the GUI Hotkey (Scroll Lock or Ctrl), twice. The toolbar appears at the upper left corner of the screen:



Depending on the settings that were selected for ID Display (see page 118), the Port Number and/or the Port Name display at the right of the toolbar. The meanings of the toolbar icons are given in a table on page 178.









When the toolbar displays, mouse input is confined to the toolbar area and keyboard input has no effect on the server connected to the port. To carry out operations on the server, close the toolbar by clicking its X icon.

To return to the Port Access *Connections* page, either click the appropriate icon (see *The Toolbar Icons*, page 178), or tap the GUI hotkey again.

- 
- Note:**
1. You can adjust the toolbar transparency (see *Video Settings*, page 95).
  2. The toolbar functions and icons are also incorporated in the Control Panel. If you choose to enable them in the Control Panel (see *Control Panel Configuration*, page 106), you can disable the Toolbar (see *User Preferences*, page 118 for details). To recall the Port Access *Connections* page when there is no Toolbar, simply tap the GUI hotkey twice.
-

## The Toolbar Icons

The meanings of the toolbar icons are explained in the table below.

Icon	Purpose
	Click to skip to the first accessible port on the entire installation, without having to recall the Port Access page.
	Click to skip to the first accessible port previous to the current one, without having to recall the Port Access page.
	Click to begin Auto Scan Mode. The KL1508Ai / KL1516Ai automatically switches among the ports that were selected for Auto Scanning. This allows you to monitor their activity without having to switch among them manually.
	Click to skip from the current port to the next accessible one, without having to recall the Port Access page.
	Click to skip from the current port to the last accessible port on the entire installation, without having to recall the Port Access page.
	Click to recall the Port Access page.
	Click to invoke Panel Array Mode (see <i>Panel Array Mode</i> , page 182).
	Click to close the toolbar.

## **Toolbar Hotkey Port Switching**

When the toolbar displays, you can use hotkeys to provide KVM focus to a port directly from the keyboard. The KL1508Ai / KL1516Ai provides the following hotkey features:

- ◆ Going directly to a port by keying in its port number and clicking **Enter**.
- ◆ Auto Scanning
- ◆ Skip Mode Switching

The hotkeys are: **A** and **P** for Auto Scanning; and the **Arrow Keys** for Skip Mode.

- 
- Note:**
1. In order for hotkey operations to take place, the toolbar must be visible (see *The Port Toolbar*, page 177).
  2. To use the keys designated as hotkeys (i.e. A, P, etc.) for normal, non-hotkey purposes, you must first close the toolbar.
  3. For issues affecting multiple user operation in Auto Scan Mode, see *Multiuser Operation*, page 184.
- 

## **Auto Scanning**

The Scan function automatically switches among all the ports that are accessible to the currently logged on user at regular intervals, so that the user can monitor their activity automatically.

- ◆ Setting the Scan Interval:

The amount of time Auto Scan dwells on each port is set with the *Scan Duration* setting (see *Scan Duration*, page 119).

- ◆ Invoking Auto Scan

To start Auto Scanning, with the toolbar showing, tap the **A** key. The Auto Scan function cycles through the ports in order – starting from the first port on the installation. An **S** appears in front of the Port ID Display to indicate that the port is being accessed under Auto Scan Mode.

- ◆ **Pausing Auto Scan**

While you are in Auto Scan Mode, you can pause the scanning in order to keep the focus on a particular server by pressing **P**. During the time that Auto Scanning is paused, the **S** in front of the Port ID blinks On and Off.

*Pausing* when you want to keep the focus on a particular server can be more convenient than exiting Auto Scan Mode because when you *Resume* scanning, you start from where you left off. If, on the other hand, you were to exit and then restart Auto Scan Mode, the scanning would start over from the very first server on the installation.

To *Resume* Auto Scanning after a pause, press any key except [Esc] or the [Spacebar]. Scanning continues from where it left off.

- ◆ **Exiting Auto Scan**

While Auto Scan Mode is in effect, ordinary keyboard functions are suspended. You must exit Auto Scan Mode in order to regain normal control of the keyboard. To exit Auto Scan Mode press [Esc] or the [Spacebar]. Auto Scanning stops when you exit Auto Scan Mode.

## **Skip Mode**

Skip Mode allows you to switch ports in order to monitor the servers manually. You can dwell on a particular port for as long or as little as you like - as opposed to Auto Scanning, which automatically switches after a fixed interval. The Skip Mode hotkeys are the four Arrow keys. Their operation is explained in the table below:

<b>Arrow</b>	<b>Action</b>
←	Skips from the current port to the first accessible port previous to it.
→	Skips from the current port to the first accessible port that comes after it.
↑	Skips from the current port to the first accessible port on the installation.
↓	Skips from the current port to the last accessible port on the installation.



## **Recalling the Port Access Page**

To dismiss the toolbar and bring back the Port Access page, do one of the following:

- ♦ Tap the GUI Hotkey once.
- ♦ From the toolbar, click the icon that recalls the Port Access page (see *The Toolbar Icons*, page 178).

The toolbar closes, and the Port Access Page appears.

## **GUI Hotkey Summary Table**

The following table presents a summary of the GUI Hotkey actions after you have accessed a port. See *User Preferences*, page 118 to set the GUI Hotkey.

<b>To...</b>		<b>Do This...</b>
Open the Toolbar		Click the GUI Hotkey twice
Open the Port Access Page	The Toolbar is open	Click the GUI Hotkey once
	The Toolbar is not open	Click the GUI Hotkey three times

## Panel Array Mode



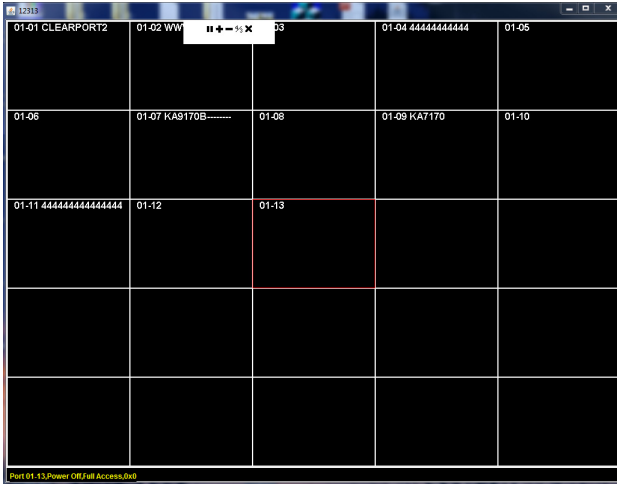



Clicking the toolbar's *Panel* icon invokes Panel Array Mode. Under this mode, the screen divides into a grid of up to 42 panels:



- ◆ Each panel represents one of the switch's ports beginning with Port 1 at the upper left, and going from left to right; top to bottom.
- ◆ The number of panels in the array can be selected by clicking the **Show More Ports**, and **Show Fewer Ports** symbols on the panel array toolbar (see the following page for an explanation of the panel array toolbar).
- ◆ Only ports that are accessible to the user are displayed. For ports that are not accessible, the panel is blank.
- ◆ If the server connected to a port is on line, its screen displays in its panel, otherwise the panel is blank.
- ◆ Mousing over a panel displays information about the port (port name, online status, port access status, and resolution).
- ◆ You can access a server connected to a port by moving the mouse pointer over its panel and clicking. You switch to the server exactly as if you had selected it from the Port Access page.

## Panel Array Toolbar

The panel array toolbar provides shortcut navigation and control of the panel array. The toolbar can be dragged anywhere on the screen. Mousing over an icon brings up a “tooltip” that provides a short description of the icon’s function. The icon functions are described in the table below:

	Click and drag to move the toolbar. <b>Note:</b> This icon is only available with the Windows Clients. To move the Java Client toolbars, click on any empty space and drag.
	Pause panel scanning, leaving the focus on the panel that currently has it.
	Show More Ports: Increase the number of panels in the array.
	Show Fewer Ports: Decrease the number of panels in the array.
	Toggle 4/3 aspect ratio.
	Exit Panel Array mode.

**Note:** For issues affecting multiple user operation in Panel Array Mode, see *Multiuser Operation*, page 184.

## Multuser Operation

The KL1508Ai / KL1516Ai supports multuser operation. When multiple users simultaneously access the switch from client computers, the rules of precedence that apply are shown in the following table:

Operation	Rule
General	The switches utilize a single shared bus implementation – although they support local and remote login at the same time, they do not support independent operation. If a local user logs in while a remote user has already opened a session, the local user sees the same screen that the remote user is working on
Auto Scan Mode	<p>If a user has invoked Auto Scan Mode (see page 179), and then another user logs on, at first the new user sees the GUI Main Page – but as soon as he accesses any port, he automatically enters Auto Scan Mode (since he is sharing the bus with the original user).</p> <p>Any user can halt Auto Scan Mode by recalling the GUI Main Page. When this occurs, Auto Scan Mode stops and all the other users on the bus are switched to the port that was being accessed when Auto Scan Mode stopped.</p>
Panel Array Mode	<ul style="list-style-type: none"> <li>◆ If a user has invoked Panel Array Mode (see page 182), and then another user logs on, the new user sees the GUI Main Page – but as soon as he accesses any port, he automatically enters Panel Array Mode (since he is sharing the bus with the original user).</li> <li>◆ Panel Array Mode continues until the original user stops it. (Administrators can override Panel Array Mode, however.)</li> <li>◆ Only the user who starts Panel Array Mode can use the Skip Mode (see page 180), function.</li> <li>◆ Only the user who starts Panel Array Mode can switch ports. Other users automatically switch to the ports that the original user selects. However, if one of the other users does not have access rights to the port that the original user switches to, that user will not be able to view the port.</li> <li>◆ Individual users can increase or decrease the number of panels they wish to view in Panel Array Mode; however, the picture quality may decrease as the number of panels increases.</li> </ul>

# Chapter 16

## The Log Server

The Windows-based Log Server is an administrative utility that records all the events that take place on selected KL1508Ai / KL1516Ai units and writes them to a searchable database. This chapter describes how to install and configure the Log Server.

### Installation

---

1. Log into the KL1508Ai / KL1516Ai (see page 67).
2. Click the *Download* tab and download the Log Server AP program.
3. Go to the location on your hard disk that you downloaded the Log Server program to, and double click its icon (*LogSetup.exe*) to bring up the Windows Client Connection Screen:

---

**Note:** If the browser cannot run the file, save it to disk, instead, and run the file from your disk.

---

The Log Server installation screen appears:

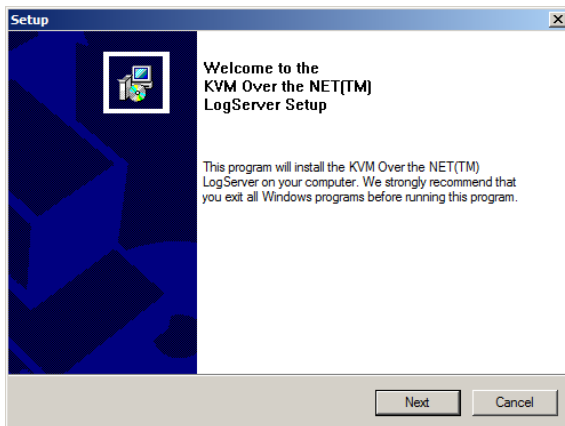

4. Click **Next**. Then follow the on-screen instructions to complete the installation and have the Log Server program icon placed on your desktop.

## Starting Up

---

To start the Log Server, either double click the program icon, or key in the full path to the program on the command line. The first time you run it, a screen similar to the one below appears:

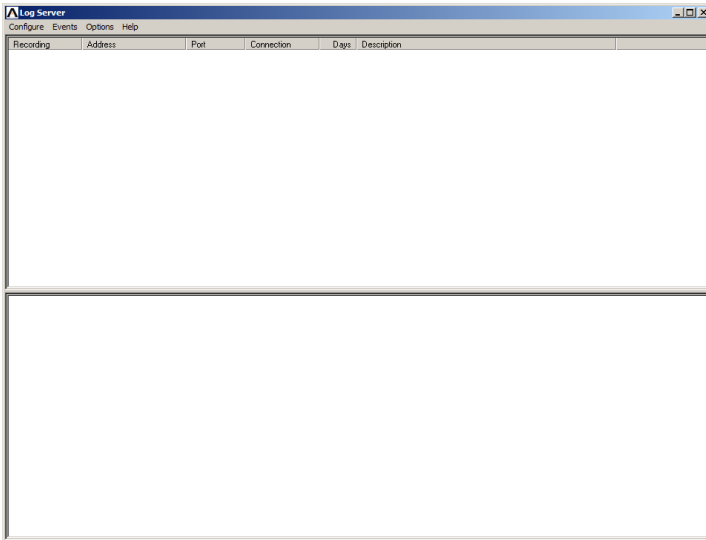

- 
- Note:**
1. The MAC address of the Log Server computer must be specified in the *<Emphasis>ANMS* settings – see *Log Server*, page 144.
  2. The Log Server requires the Microsoft Jet OLEDB 4.0 driver. See *The Log Server program does not run.*, page 215 if the program doesn't start.
- 

The screen is divided into three components:

- ♦ A *Menu Bar* at the top
- ♦ A panel that will contain a list of KL1508Ai / KL1516Ai in the middle (see *The Log Server Main Screen*, page 191).
- ♦ A panel that will contain an *Events List* at the bottom

Each of the components is explained in the sections that follow.

---

## The Menu Bar

---

The Menu bar consists of four items:

- ◆ Configure
- ◆ Events
- ◆ Options
- ◆ Help

These are discussed in the sections that follow.

---

**Note:** If the Menu Bar appears to be disabled, click in the List window to enable it.

---

### Configure

The Configure menu contains three items: Add; Edit; and Delete. They are used to add new units to the List; edit the information for units already on the list; or delete units from the list.

- ◆ To add a unit to the list, click **Add**.
- ◆ To edit or delete a listed unit, first select the target in the List window, then open this menu and click **Edit** or **Delete**.

When you choose *Add* or *Edit*, a dialog box, similar to the one below, appears:

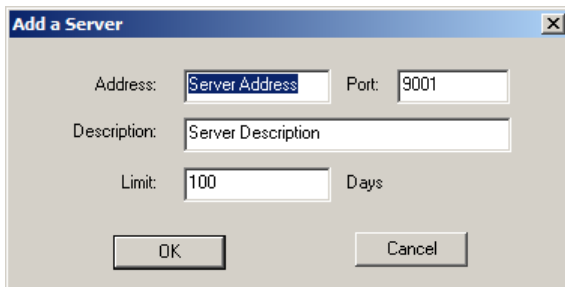

The screenshot shows a dialog box titled "Add a Server" with a close button (X) in the top right corner. The dialog contains the following fields and controls:

- Address:** A text input field containing "Server Address".
- Port:** A text input field containing "9001".
- Description:** A text input field containing "Server Description".
- Limit:** A text input field containing "100", followed by the text "Days".
- Buttons:** "OK" and "Cancel" buttons at the bottom.

A description of the fields is given in the table below:

Field	Explanation
Address	This can either be the IP address of the computer the Log Server is running on, or its DNS name.
Port	The port number that was assigned to the Log Server under <i>Device Management</i> (see <i>Log Server</i> , page 144).
Description	This field is provided so that you can put in a descriptive reference for the unit to help identify it.
Limit	This specifies the number of days that an event should be kept in the Log Server's database. Events that exceed the amount of time specified here can be removed with the Maintenance function (see <i>Maintenance.</i> , page 189).

Fill in or modify the fields, then click **OK** to finish.

## Events

The Events Menu has two items: *Search* and *Maintenance*.

### Search:

*Search* allows you to search for events containing specific words or strings. When you access this function, a screen, similar to the one below, appears:

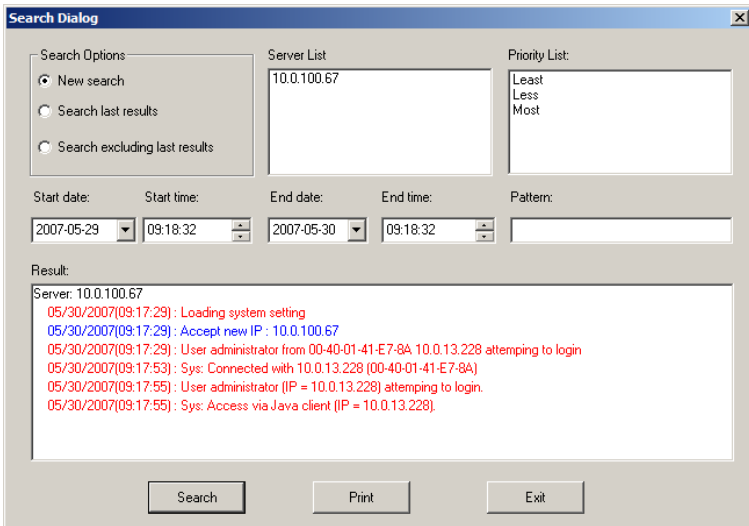



A description of the items is given in the table, below:

Item	Description
New search	This is one of three radio buttons that define the scope of the search. If it is selected, the search is performed on all the events in the database for the selected unit.
Search last results	This is a secondary search performed on the events that resulted from the previous search.
Search excluding last results	This is a secondary search performed on all the events in the database for the selected unit excluding the events that resulted from the previous search.
Server List	KL1508Ai / KL1516Ai units are listed according to their IP address. Select the unit that you want to perform the search on from this list. You can select more than one unit for the search. If no units are selected, the search is performed on all of them.
Priority	Sets the level for how detailed the search results display should be. <i>Least</i> is the most general; <i>Most</i> is the most specific. Least results appear in black; Less results appear in blue; Most results appear in red.
Start Date	Select the date that you want the search to start from. The format follows the YYYY/MM/DD convention, as follows: 2009/11/04
Start Time	Select the time that you want the search to start from. The format follows the HH:MM:SS convention.
End Date	Select the date that you want the search to end at.
End Time	Select the time that you want the search to end at.
Pattern	Key in the pattern that you are searching for here. The multiple character wildcard (%) is supported. E.g., h%ds would match hands and hoods.
Results	Lists the events that contained matches for the search.
Search	Click this button to start the search.
Print	Click this button to print the search results.
Export	Click this button to save the search results to file.
Exit	Click this button to exit the Log Server.

### Maintenance:

This function allows the administrator to perform manual maintenance of the database, such as erasing specified records before their expiration time is up.

## **Options**

*Network Retry* allows you to set the number of seconds that the Log Server should wait before attempting to connect if its previous attempt to connect failed. When you click this item, a dialog box, similar to the one below, appears:

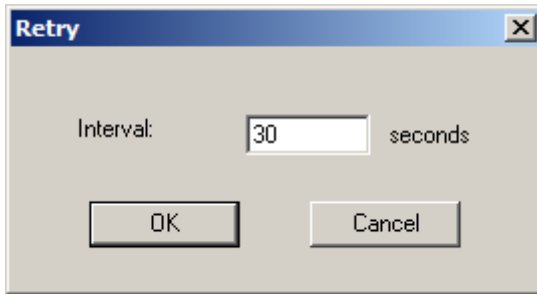

Key in the number of seconds, then click **OK** to finish.

## **Help**

From the Help menu, click Contents to access the online Windows Help file. The help file contains instructions about how to setup, operation and troubleshoot the Log Server.

## The Log Server Main Screen

### Overview

The Log Server Main Screen is divided into two main panels.

- ◆ The upper (List) panel lists all of the units that have been selected for the Log Server to track (see *Configure*, page 187).
- ◆ The lower (Event) panel displays the tick information for the currently selected unit. (If there are more than one unit, the selected unit is the one that is highlighted).
- ◆ To select a unit in the list, simply click on it.

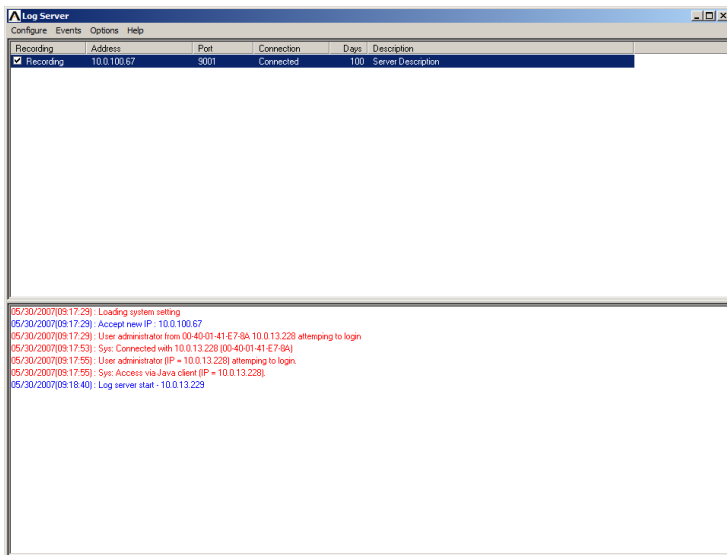

## The List Panel

The List panel contains six fields:

Field	Explanation
Recording	Determines whether the Log Server records the ticks for this unit, or not. If the Recording checkbox is checked, the field displays <i>Recording</i> , and the ticks are recorded. If the Recording checkbox is not checked, the field displays <i>Paused</i> , and the ticks are not recorded. <b>Note:</b> Even though a unit is not the currently selected one, if its Recording checkbox is checked, the Log Server will still record its ticks.
Address	This is the IP Address or DNS name that was given to the unit when it was added to the Log Server (see <i>Configure</i> , page 187).
Port	This is the Access Port number assigned to the unit (see <i>Configure</i> , page 187).
Connection	<ul style="list-style-type: none"> <li>◆ If the Log Server is connected to the unit, this field displays <i>Connected</i>.</li> <li>◆ If the Log Server is not connected, this field displays <i>Waiting</i>. This means that the Log Server's MAC address has not been set properly. It needs to be set on the <i>Date/Time</i>, page 159.</li> </ul>
Days	This field displays the number of days that the unit's log events are to be kept in the Log Server's database before expiration (see <i>Configure</i> , page 187).
Description	This field displays the descriptive information given for the unit when it was added to the Log Server (see <i>Configure</i> , page 187).

## The Event Panel

The lower panel displays log events for the currently selected unit. Note that if there are more than one units, even though they aren't currently selected, if their *Recording* checkbox is checked, the Log Server records their log events and keeps them in its database.

## Safety Instructions

---

### General

- ◆ This product is for indoor use only.
- ◆ Read all of these instructions. Save them for future reference.
- ◆ Follow all warnings and instructions marked on the device.
- ◆ Do not place the device on any unstable surface (cart, stand, table, etc.). If the device falls, serious damage will result.
- ◆ Do not use the device near water.
- ◆ Do not place the device near, or over, radiators or heat registers.
- ◆ The device cabinet is provided with slots and openings to allow for adequate ventilation. To ensure reliable operation, and to protect against overheating, these openings must never be blocked or covered.
- ◆ The device should never be placed on a soft surface (bed, sofa, rug, etc.) as this will block its ventilation openings. Likewise, the device should not be placed in a built in enclosure unless adequate ventilation has been provided.
- ◆ Never spill liquid of any kind on the device.
- ◆ Unplug the device from the wall outlet before cleaning. Do not use liquid or aerosol cleaners. Use a damp cloth for cleaning.
- ◆ The device should be operated from the type of power source indicated on the marking label. If you are not sure of the type of power available, consult your dealer or local power company.
- ◆ The device is designed for IT power distribution systems with 230V phase-to-phase voltage.
- ◆ To prevent damage to your installation it is important that all devices are properly grounded.
- ◆ The device is equipped with a 3-wire grounding type plug. This is a safety feature. If you are unable to insert the plug into the outlet, contact your electrician to replace your obsolete outlet. Do not attempt to defeat the purpose of the grounding-type plug. Always follow your local/national wiring codes.
- ◆ Do not allow anything to rest on the power cord or cables. Route the power cord and cables so that they cannot be stepped on or tripped over.

- ◆ Avoid circuit overloads. Before connecting equipment to a circuit, know the power supply's limit and never exceed it. Always review the electrical specifications of a circuit to ensure that you are not creating a dangerous condition or that one doesn't already exist. Circuit overloads can cause a fire and destroy equipment.
- ◆ If an extension cord is used with this device make sure that the total of the ampere ratings of all products used on this cord does not exceed the extension cord ampere rating. Make sure that the total of all products plugged into the wall outlet does not exceed 15 amperes.
- ◆ To help protect your system from sudden, transient increases and decreases in electrical power, use a surge suppressor, line conditioner, or uninterruptible power supply (UPS).
- ◆ Position system cables and power cables carefully; Be sure that nothing rests on any cables.
- ◆ Never push objects of any kind into or through cabinet slots. They may touch dangerous voltage points or short out parts resulting in a risk of fire or electrical shock.
- ◆ Do not attempt to service the device yourself. Refer all servicing to qualified service personnel.
- ◆ If the following conditions occur, unplug the device from the wall outlet and bring it to qualified service personnel for repair.
  - ◆ The power cord or plug has become damaged or frayed.
  - ◆ Liquid has been spilled into the device.
  - ◆ The device has been exposed to rain or water.
  - ◆ The device has been dropped, or the cabinet has been damaged.
  - ◆ The device exhibits a distinct change in performance, indicating a need for service.
  - ◆ The device does not operate normally when the operating instructions are followed.
- ◆ Only adjust those controls that are covered in the operating instructions. Improper adjustment of other controls may result in damage that will require extensive work by a qualified technician to repair.
- ◆ Do not connect the RJ-11 connector marked "UPGRADE" to a public telecommunications network.

## **Rack Mounting**

- ◆ Before working on the rack, make sure that the stabilizers are secured to the rack, extended to the floor, and that the full weight of the rack rests on the floor. Install front and side stabilizers on a single rack or front stabilizers for joined multiple racks before working on the rack.
- ◆ Always load the rack from the bottom up, and load the heaviest item in the rack first.
- ◆ Make sure that the rack is level and stable before extending a device from the rack.
- ◆ Use caution when pressing the device rail release latches and sliding a device into or out of a rack; the slide rails can pinch your fingers.
- ◆ After a device is inserted into the rack, carefully extend the rail into a locking position, and then slide the device into the rack.
- ◆ Do not overload the AC supply branch circuit that provides power to the rack. The total rack load should not exceed 80 percent of the branch circuit rating.
- ◆ Make sure that all equipment used on the rack - including power strips and other electrical connectors - are properly grounded.
- ◆ Ensure that proper airflow is provided to devices in the rack.
- ◆ Ensure that the operating ambient temperature of the rack environment does not exceed the maximum ambient temperature specified for the equipment by the manufacturer.
- ◆ Do not step on or stand on any device when servicing other devices in a rack.
- ◆ **Caution:** Slide/rail (LCD KVM) mounted equipment is not to be used as a shelf or a work space.



## Technical Support

---

Technical support is available both by email and online (with a browser over the web):

### **International**

- ◆ For online technical support – including troubleshooting, documentation, and software updates: **<http://support.aten.com>**
- ◆ For telephone support, see *Telephone Support*, page iii:

### **North America**

Email Support		<a href="mailto:support@aten-usa.com">support@aten-usa.com</a>
Online Technical Support	Troubleshooting Documentation Software Updates	<a href="http://support.aten.com">http://support.aten.com</a>
Telephone Support		1-888-999-ATEN ext 4988

When you contact us, please have the following information ready beforehand:

- ◆ Product model number, serial number, and date of purchase.
- ◆ Your computer configuration, including operating system, revision level, expansion cards, and software.
- ◆ Any error messages displayed at the time the error occurred.
- ◆ The sequence of operations that led up to the error.
- ◆ Any other information you feel may be of help.



# Specifications

## KL1508AiM / KL1508AiN

Function	KL1508AiM	KL1508AiN
<b>Console Connections</b>		
Local	1 (Share Remote Bus)	
Remote	1	
<b>Computer Connections</b>		
Direct	8	
Maximum	128 (via Daisy-chain)	
<b>Port Selection</b>	OSD, Hotkey, Pushbutton	
<b>Connectors</b>		
Console Ports	2 x USB Type-A Female (White) 1 x 6-pin Mini-DIN Female (Purple) 1 x 6-pin Mini-DIN Female (Green) 1 x HDB-15 Female (Blue)	
External Mouse Port	1 x USB Type-A Female	
KVM Ports	8 x RJ-45 Female	
Daisy Chain Ports	1 x DB-25 Male	
PON	1 x RJ-45 Female	
Firmware Upgrade	1 x RJ-11 Female	
LAN Ports	1 x RJ-45 Female	
Power	1 x IEC 60320/C14	
<b>Switches</b>		
Port Selection	8 x Pushbutton	
Station Selection	2 x Pushbutton	
Reset	1 x Semi-recessed Pushbutton	
Firmware Upgrade	1 x Slide Switch	
Power	1 x Rocker Switch	
LCD Power	1 x Pushbutton	
LCD Adjustment	4 x Pushbutton	

Function	KL1508AiM	KL1508AiN
<b>LEDs</b>		
Online	8 (Green)	
Selected	8 (Orange)	
Station Selection	2 x 7 Segments (Orange)	
Link	1 (Green)	
10/100/1000 Mbps	non-FHD: 10/100 Mbps (Orange / Green) FHD: 100/1000 Mbps (Orange / Green)	
Power	1 (Blue)	
LCD Power	1 (Orange)	
Lock	1 x Num Lock (Green) 1 x Caps Lock (Green) 1 x Scroll Lock (Green)	
<b>Video</b>		
Local / Remote	FHD: 1920 x 1200 @ 60 Hz* Non-FHD: 1600 x 1200 @ 60 Hz	
<b>Panel Spec</b>		
LCD Module	17" TFT-LCD	19" TFT-LCD
Resolution	1280 x 1024 @ 75 Hz	
Pixel Pitch	0.264 mm x 0.264 mm	0.294 mm x 0.294 mm
Response Time	5 ms	
Viewing Angle	170° (H), 160° (V)	
Support Color	16.7M colors	
Contrast Ratio	1000:01:00	
Luminance	250 cd/m <sup>2</sup>	
<b>Emulation</b>		
Keyboard / Mouse	PS/2; USB	
Scan Interval	1–255 sec.	
Maximum Input Power Rating	100–240V AC, 50-60Hz, 1A	
Power Consumption	AC110V: 21.1W:110BTU AC220V: 22.2W:115BTU	AC110V: 24.3W:125BTU AC220V: 24.5W:126BTU
<b>Environmental</b>		
Operating Temperature	0 - 40°C	

Function	KL1508AiM	KL1508AiN
Storage Temperature	-20 - 60°C	
Humidity	0–80% RH, Non-condensing	
<b>Physical Properties</b>		
Housing	Metal	
Weight	15.23 kg (33.55 lb)	15.39 kg (33.9 lb)
Dimensions	48.00 x 70.12 x 4.40 cm (18.9 x 27.61 x 1.73 in.)	

\*Please check the product label to ensure it's the FHD version.

**KL1516AiM / KL1516AiN**

Function	KL1516AiM	KL1516AiN
<b>Console Connections</b>		
Local	1 (Share Remote Bus)	
Remote	1	
<b>Computer Connections</b>		
Direct	16	
Maximum	256 (via Daisy-chain)	
<b>Port Selection</b>	OSD, Hotkey, Pushbutton	
<b>Connectors</b>		
Console Ports	2 x USB Type-A Female (White) 1 x 6-pin Mini-DIN Female (Purple) 1 x 6-pin Mini-DIN Female (Green) 1 x HDB-15 Female (Blue)	
External Mouse Port	1 x USB Type-A Female	
KVM Ports	16 x RJ-45 Female	
Daisy Chain Ports	1 x DB-25 Male	
PON	1 x RJ-45 Female	
Firmware Upgrade	1 x RJ-11 Female	
LAN Ports	1 x RJ-45 Female	
Power	1 x IEC 60320/C14	
<b>Switches</b>		
Port Selection	16 x Pushbutton	
Station Selection	2 x Pushbutton	
Reset	1 x Semi-recessed Pushbutton	
Firmware Upgrade	1 x Slide	
Power	1 x Rocker	
LCD Power	1 x Pushbutton	
LCD Adjustment	4 x Pushbutton	
<b>LEDs</b>		
Online	16 (Green)	
Selected	16 (Orange)	

Function	KL1516AiM	KL1516AiN
Station Selection	2 x 7 Segments (Orange)	
Link	1 (Green)	
10/100/1000 Mbps	non-FHD: 10/100 Mbps (Orange/Green) FHD: 100/1000 Mbps (Orange/Green)	
Power	1 (Blue)	
LCD Power	1 (Orange)	
Lock	1 x Num Lock (Green) 1 x Caps Lock (Green) 1 x Scroll Lock (Green)	
<b>Video</b>		
Local / Remote	FHD: 1920 x 1200 @ 60 Hz* Non-FHD: 1600 x 1200 @ 60 Hz	
<b>Panel Spec</b>		
LCD Module	17" TFT-LCD	19" TFT-LCD
Resolution	1280 x 1024 @ 75 Hz	
Pixel Pitch	0.264 mm x 0.264 mm	0.294 mm x 0.294 mm
Response Time	5 ms	
Viewing Angle	170° (H), 160° (V)	
Support Color	16.7M colors	
Contrast Ratio	1000:1	
Luminance	250 cd/m <sup>2</sup>	
<b>Emulation</b>		
Keyboard / Mouse	PS/2; USB	
Scan Interval	1–255 sec.	
Maximum Input Power Rating	100–240V AC, 50-60Hz, 1A	
Power Consumption	AC110V: 21.2W:110BTU AC220V: 23.1W:119BTU	AC110V: 24.4W:125BTU AC220V: 25.4W:130BTU
<b>Environmental</b>		
Operating Temperature	0 - 40°C	
Storage Temperature	-20 - 60°C	
Humidity	0–80% RH, Non-condensing	
<b>Physical Properties</b>		

<b>Function</b>	<b>KL1516AiM</b>	<b>KL1516AiN</b>
Housing	Metal	
Weight	15.24 kg (33.57 lb)	15.40 kg (33.92 lb)
Dimensions	48.00 x 70.12 x 4.40 cm (18.9 x 27.61 x 1.73 in.)	

\*Please check the product label to ensure it's the FHD version.

## IP Address Determination

If you are an administrator logging in for the first time, you need to access the KL1508Ai / KL1516Ai in order to give it an IP address that users can connect to. There are three methods to choose from. In each case, your client computer must be on the same network segment as the KL1508Ai / KL1516Ai. After you have connected and logged in you can give the KL1508Ai / KL1516Ai its fixed network address. (See *Network*, page 140.)

### The Local Console

The easiest way to assign an IP address is from the local console. Refer to *SET IP ADDRESS*, page 47, for details on the procedure involved.

### IP Installer

For client computers running Windows, an IP address can be assigned with the *IP Installer* utility. The utility can be obtained from the *Download* area of our website. Look under *Driver/SW*, and the model of your switch. After downloading the utility to your client computer, do the following:

1. Unzip the contents of *IPInstaller.zip* to a directory on your hard drive.
2. Go to the directory that you unzipped the IPInstaller program to and run *IPInstaller.exe*. A dialog box similar to the one below appears:

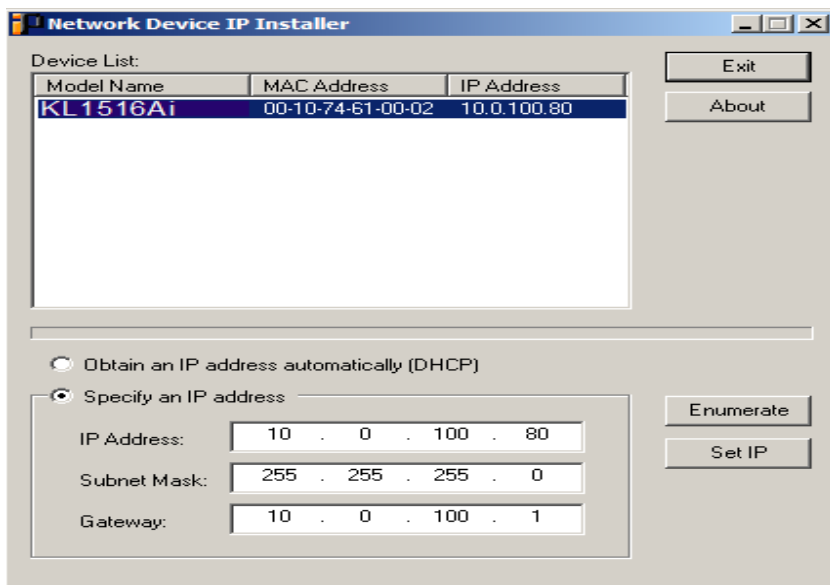

3. Select the KL1508Ai / KL1516Ai in the *Device List*.

---

**Note:** 1. If the list is empty, or your device doesn't appear, click **Enumerate** to refresh the Device List.

2. If there is more than one device in the list, use the MAC address to pick the one you want.
- 

4. Select either *Obtain an IP address automatically (DHCP)*, or *Specify an IP address*. If you chose the latter, fill the IP Address, Subnet Mask, and Gateway fields with the information appropriate to your network.
5. Click **Set IP**.
6. After the IP address shows up in the Device List, click **Exit**. See *IP Installer*, page 141 for more information.

## **Browser**

1. Set your client computer's IP address to 192.168.0.XXX  
Where *XXX* represents any number or numbers except 60. (192.168.0.60 is the default address of the KL1508Ai / KL1516Ai.)
2. Specify the switch's default IP address (192.168.0.60) in your browser, and you will be able to connect.
3. Assign a fixed IP address for the KL1508Ai / KL1516Ai that is suitable for the network segment that it resides on.

After you log out, reset your client computer's IP address to its original value.



---

## IPv6

---

At present, the KL1508Ai / KL1516Ai supports three IPv6 address protocols: *Link Local IPv6 Address*, *IPv6 Stateless Autoconfiguration*, and *Stateful Autoconfiguration (DHCPv6)*.

### **Link Local IPv6 Address**

At power on, the KL1508Ai / KL1516Ai is automatically configured with a Link Local IPv6 Address (for example, fe80::210:74ff:fe61:1ef). To find out what the Link Local IPv6 Address is, log in with the KL1508Ai / KL1516Ai IPv4 address and open the *Device Management* → *Device Information* page. The address is displayed in the *General* list box (see page 138).

Once you have determined what the IPv6 address is, you can use it when logging in from a browser or the Win and Java Client AP programs.

For example:

If you are logging in from a browser, you would key in

```
http://[fe80::2001:74ff:fe6e:59%5]
```

for the URL bar.

If you are logging in with the AP program, you would key:

```
fe80::2001:74ff:fe6e:59%5
```

for the *IP* field of the *Server* panel (see *Windows Client AP Login*, page 70).

- 
- Note:**
1. To log in with the Link Local IPv6 Address, the client computer must be on the same local network segment as the KL1508Ai / KL1516Ai
  2. The %5 is the %interface used by the client computer. To see your client computer's IPv6 address: from the command line issue the following command: `ipconfig /all`. The % value appears at the end of the IPv6 address.
-

## **IPv6 Stateless Autoconfiguration**

If the KL1508Ai / KL1516Ai network environment contains a device (such as a router) that supports the IPv6 Stateless Autoconfiguration function, the KL1508Ai / KL1516Ai can obtain its prefix information from that device in order to generate its IPv6 address. For example, 2001::74ff:fe6e:59.

As above, the address is displayed in the *General* list box of the *Device Management* → *Device Information* page (see page 138).

Once you have determined what the IPv6 address is, you can use it when logging in from a browser or the Win and Java Client AP programs.

For example:

If you are logging in from a browser, you would key in

```
http://[2001::74ff:fe6e:59]
```

for the URL bar.

If you are logging in with the AP program, you would key:

```
2001::74ff:fe6e:59
```

for the *IP* field of the *Server* panel (see *Windows Client AP Login*, page 70).

---

## Trusted Certificates

---

### Overview

When you try to login to the KL1508Ai / KL1516Ai from your Web browser, a Security Alert message appears to inform you that the device's certificate is not trusted, and asks if you want to proceed.

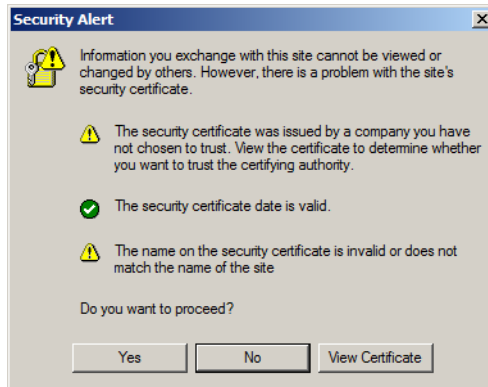

The certificate can be trusted, but the alert is triggered because the certificate's name is not found on Microsoft's list of Trusted Authorities. You have two options: 1) you can ignore the warning and click **Yes** to go on; or 2) you can install the certificate and have it be recognized as trusted.

- ◆ If you are working on a computer at another location, accept the certificate for just this session by clicking **Yes**.
- ◆ If you are working at your own computer, install the certificate on your computer (see below for details). After the certificate is installed, it will be recognized as trusted.

## Installing the Certificate

To install the certificate:

1. In the **Security Alert** dialog box, click **View Certificate**. The **Certificate** dialog box appears.

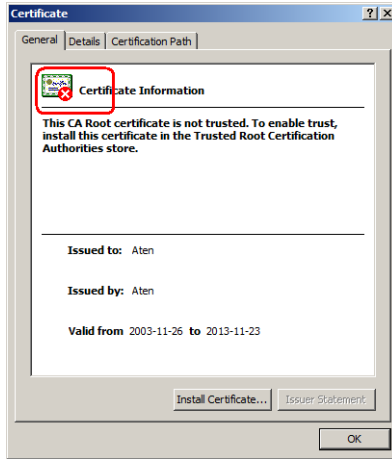

**Note:** There is a red and white **X** logo over the certificate to indicate that it is not trusted.

2. Click **Install Certificate**.
3. Follow the Installation Wizard to complete the installation. Unless you have a specific reason to choose otherwise, accept the default options. The Wizard presents a caution screen:

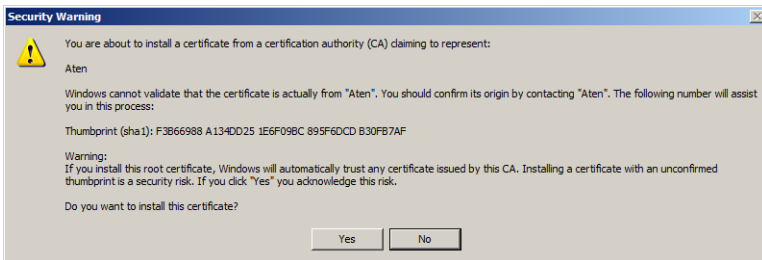

4. Click **Yes**.

5. Click **Finish** to complete the installation.
6. Click **OK** to close the dialog box.

## Certificate Trusted

The certificate is now trusted:



When you click **View Certificate**, you can see that the red and white X logo is no longer present – further indication that the certificate is trusted.

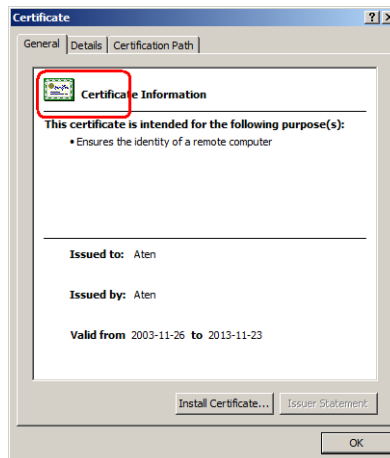

## Self-Signed Private Certificates

---

If you wish to create your own self-signed encryption key and certificate, a free utility – `openssl.exe` – is available for download over the web at [www.openssl.org](http://www.openssl.org). To create your private key and certificate do the following:

1. Go to the directory where you downloaded and extracted *openssl.exe* to.
2. Run `openssl.exe` with the following parameters:

```
openssl req -new -newkey rsa:1024 -days 3653 -nodes -x509  
-keyout CA.key -out CA.cer -config openssl.cnf
```

- 
- Note:**
1. The command should be entered all on one line (i.e., do not press [Enter] until all the parameters have been keyed in).
  2. If there are spaces in the input, surround the entry in quotes (e.g., “ATEN International”).
- 

To avoid having to input information during key generation the following additional parameters can be used: `/C /ST /L /O /OU /CN /emailAddress`.

### Examples

```
openssl req -new -newkey rsa:1024 -days 3653 -nodes -x509  
-keyout CA.key -out CA.cer -config openssl.cnf -subj  
/C=yourcountry/ST=yourstateorprovince/L=yourlocationor  
city/O=yourorganization/OU=yourorganizationalunit/  
CN=yourcommonname/emailAddress=name@yourcompany.com
```

```
openssl req -new -newkey rsa:1024 -days 3653 -nodes -x509  
-keyout CA.key -out CA.cer -config openssl.cnf -subj  
/C=CA/ST=BC/L=Richmond/O="ATEN International"/OU=ATEN  
/CN=ATEN/emailAddress=eservice@aten.com.tw
```

### Importing the Files

After the `openssl.exe` program completes, two files – `CA.key` (the private key) and `CA.cer` (the self-signed SSL certificate) – are created in the directory that you ran the program from. These are the files that you upload in the *Private Certificate* panel of the Security page (see page 156).

## Troubleshooting

### Administration

Problem	Resolution
After upgrading firmware, the KL1508Ai / KL1516Ai still appears to be using the old firmware version.	Your Internet browser is displaying cached web pages – not new ones. Clear your browser cache; delete all temporary Internet files and cookies, close the Internet browser, and then open a new instance of the browser.
The default network setting for the KL1508Ai / KL1516Ai is DHCP, but the network uses fixed IP addresses and doesn't have a DHCP server.	Use the local console OSD's F4 function to give the KL1508Ai / KL1516Ai a fixed IP address. See page 140, for details.

### General Operation

Problem	Resolution
Erratic Operation	Press and hold the Reset Switch (see page 11) for longer than three seconds.
Mouse and/or keyboard not responding due to improper mouse and/or keyboard reset.	Unplug the cable(s) from the console port(s), then plug it back in again.
Sudden loss of network connection due to local reset of KL1508Ai / KL1516Ai.	Close your KL1508Ai / KL1516Ai connection. Wait approximately 30 seconds, and log in again.
Mouse Pointer Confusion	If you find the display of two mouse pointers (local and remote) to be confusing or annoying, you can use the <i>Toggle Mouse Display</i> function to shrink the non-functioning pointer. See page 87 for details.
Some characters that are keyed in don't display on the remote system	This is usually due to the local OS keyboard language and the remote OS keyboard language being different. Make sure that the keyboard language for both systems are the same.
Keyboard and/or mouse do not work after computer boots up.	For computers with PS/2 connectors, if you are using 2L-520xP cables, make sure that all the connectors (keyboard, video, and mouse) are plugged into their ports on the computer before starting the computer. Plugging the cables in after the computer has booted will not resolve the problem.

Problem	Resolution
When I emulate the Sun keyboard, I can't go into OK Mode ([Stop] [A]).	<p>To go into OK Mode, use the following key sequence:</p> <ol style="list-style-type: none"> <li>1. Press and release [Ctrl].</li> <li>2. Press and hold [T].</li> <li>3. Press and hold [A].</li> <li>4. Release [T] and [A] together.</li> </ol>
There are ghost images on the external monitor.	<p>The distance between the external console and the KL1508Ai / KL1516Ai is too great. The maximum VGA cable distance should not exceed 20m and, in some cases, may need to be shorter. Replace the VGA cable with one of an appropriately short length.</p>
I can't set the computers' screen resolutions higher than 1280 x 1024, even though the KL1508Ai / KL1516Ai supports 1920 x 1200 for remote computers.	<p>The maximum screen resolution of the KL1508Ai / KL1516Ai's integrated LCD monitor is 1280 x 1024. In order to protect it from being damaged by resolutions that are beyond its display capability, we recommend that the screen resolutions of the connected computers be set to 1280 x 1024 or lower.</p> <p>If you wish to set the screen resolutions of the connected computers to something higher than 1280 x 1024, see <i>Screen Resolutions Higher than 1280 x 1024</i>, page 217.</p>
When I switch to one of the computers on my installation, the LCD monitor screen goes blank. All I see is a black screen.	<p>The maximum screen resolution of the KL1508Ai / KL1516Ai's integrated LCD monitor is 1280 x 1024. The screen resolution of the problem computer is set to something that is too high for the KL1508Ai / KL1516Ai's LCD monitor to display.</p> <p>To resolve the problem, connect an external KVM console (with a monitor capable of displaying the problem computer's screen resolution) to the KL1508Ai / KL1516Ai's external console ports. Use the external console to access the problem computer and reduce its resolution to 1280 x 1024.</p> <p><b>Note:</b> Although the LCD monitor only supports video resolutions of up to 1280 x 1024, the KL1508Ai / KL1516Ai, itself can support video resolutions up to 1920 x 1200 @ 60 Hz. If you wish to set the screen resolutions of the connected computers to something higher than 1280 x 1024, see <i>Screen Resolutions Higher than 1280 x 1024</i>, page 217 for details.</p>



---

Problem	Resolution
My ATEN over IP unit is not listed in the Device List of IP Installer.	<ul style="list-style-type: none"><li>◆ Make sure the Broadcast function is enabled from your switch or router in order for the auto-discover to work properly.</li><li>◆ Make sure to turn off your firewall and/or antivirus software temporarily in order for the auto-discover to work properly.</li><li>◆ Make sure the ATEN over IP unit and the PC are under the same network segment.</li></ul>

---

## The Windows Client

Problem	Resolution
Won't connect to the KL1508Ai / KL1516Ai.	DirectX 8.0 or higher must be installed on your computer.
Remote mouse pointer is out of sync.	<ol style="list-style-type: none"> <li>1. Use the <i>AutoSync</i> feature (see <i>Video Settings</i>, page 95), to sync the local and remote monitors.</li> <li>2. If that doesn't resolve the problem, use the <i>Adjust Mouse</i> feature (see <i>Manual Mouse Synchronization</i>, page 105) to bring them back in sync.</li> <li>3. If the two methods described above fail to resolve the problem, use the <i>Toggle Mouse Display</i> function (see page 87).</li> </ol>
Part of remote window is off my monitor.	Use the <i>AutoSync</i> feature (see <i>Video Settings</i> , page 95) to synchronize the local and remote monitors.
My antivirus program reports that there is a trojan after I access the KL1508Ai / KL1516Ai with my browser and then open the Windows Client Viewer.	The Windows Client Viewer uses an ActiveX plug-in (windows.ocx) that some antivirus programs mistakenly see as a virus or trojan. We have tested our firmware extensively and found no evidence of a virus or trojan. You can add the plug-in to your antivirus program's White List and use the Viewer safely. If you are reluctant to use the Windows Client Viewer, however, you can simply use the Java Client Viewer, instead.

## The Java Client

For connection and operation problems, see the table below:

Problem	Resolution
Java Client won't connect to the KL1508Ai / KL1516Ai.	<ol style="list-style-type: none"> <li>1. Java JRE 6 update 3 or higher must be installed on your computer.</li> <li>2. Make sure to include the correct name of the web page when you specify the KL1508Ai / KL1516Ai's IP address.</li> <li>3. Close the Java Client, reopen it, and try again.</li> </ol>
Pressing the Windows Menu key has no effect.	Java doesn't support the Windows Menu key.
Java Client performance deteriorates.	Exit the program and start again.
National language characters do not appear.	When entering national language characters, if your local keyboard is set to a non-English national language layout, you must set the remote computer's keyboard layout to English.

## The Log Server

Problem	Resolution
The Log Server program does not run.	<p>The Log Server requires the Microsoft Jet OLEDB 4.0 driver in order to access the database.</p> <p>This driver is automatically installed with Windows ME, 2000, and XP.</p> <p>For Windows 98 and NT you will have to go to the Microsoft download site:</p> <p style="padding-left: 40px;"><a href="http://www.microsoft.com/data/download.htm">http://www.microsoft.com/data/download.htm</a></p> <p>to retrieve the driver file:</p> <p style="padding-left: 40px;"><b><i>MDAC 2.7 RTM Refresh (2.70.9001.0)</i></b></p> <p>Since this driver is used in Windows Office Suite, an alternate method of obtaining it is to install Windows Office Suite. Once the driver file or Suite has been installed, the Log Server will run.</p>

## Panel Array Mode

Problem	Resolution
Low resolution video in Panel Array Mode.	Increase the number of panels that are displayed.
Some users only receive a partial image when multiple remote users are logged in concurrently.	The first user to invoke Panel Array Mode should set it to display a minimum of four panels.

## Sun Systems

Problem	Resolution
<p>Video display problems with HDB-15 interface systems (e.g. Sun Blade 1000 servers).</p>	<p>The display resolution should be set to 1024 x 768.</p> <p>Under Text Mode:</p> <ol style="list-style-type: none"> <li>Go to <b>OK mode</b> and issue the following commands:                     <pre>setenv output-device screen:r1024x768x60 reset-all</pre> </li> </ol> <p>Under XWindow:</p> <ol style="list-style-type: none"> <li>Open a console and issue the following command:                     <pre>m64config -res 1024x768x60</pre> </li> <li>Log out.</li> <li>Log in.</li> </ol>
<p>Video display problems with 13W3 interface systems (e.g. Sun Ultra servers).*</p>	<p>The display resolution should be set to 1024 x 768.</p> <p>Under Text Mode:</p> <ol style="list-style-type: none"> <li>Go to <b>OK mode</b> and issue the following commands:                     <pre>setenv output-device screen:r1024x768x60 reset-all</pre> </li> </ol> <p>Under XWindow:</p> <ol style="list-style-type: none"> <li>Open a console and issue the following command:                     <pre>ffbconfig -res 1024x768x60</pre> </li> <li>Log out.</li> <li>Log in.</li> </ol>

---

\* These solutions work for most common Sun VGA cards. If using them fails to resolve the problem, consult the Sun VGA card's manual.

---

---

## Screen Resolutions Higher than 1280 x 1024

The maximum screen resolution of the KL1508Ai / KL1516Ai's integrated LCD monitor is 1280 x 1024. In order to protect it from being damaged by resolutions that are beyond its display capability, we recommend that the screen resolutions of the connected computers be set to 1280 x 1024 or lower.

If you wish to display screen resolutions higher than 1280 x 1024, follow the procedure described below to change the computers' screen resolutions and safeguard the KL1508Ai / KL1516Ai's LCD monitor:

---

**Note:** We strongly recommend that you close the KL1508Ai / KL1516Ai LCD console before continuing (see *Closing the Console*, page 31.) Using the LCD monitor to view computers that are set to resolutions that exceed its maximum capability can damage it and shorten its life span.

To access computers from the external local console when the integrated console is closed, simply connect an external KVM console with a monitor that supports 1920 x 1200 @ 60 Hz to the KL1508Ai / KL1516Ai's external console ports.

---

1. From a remote computer, log into the KL1508Ai / KL1516Ai and access the computer whose screen resolution you wish to change.
2. Open the computer's *Control Panel* and double-click **Display**. The *Display Properties* dialog box appears.
3. Click the **Settings** tab, and then click **Advanced**.
4. In the dialog box that appears, click the **Monitor** tab.
5. Under *Monitor settings*, click to clear the *Hide modes that this monitor cannot display* check box.
6. Click **Apply**.
7. Click the **Adapter** tab, and then click **List All Modes**. The *List All Modes* dialog box appears.
8. Under *List of valid modes*, select the display mode that you want the computer to use.

---

**Note:** The maximum screen resolution and refresh rate that the KL1508Ai / KL1516Ai FHD version supports for the external local console and the remote computers is 1920 x 1200@60 Hz.

---

9. Click **OK**, and then click **Apply**. The display mode changes to the one you selected.
10. If the *Monitor Settings* dialog box appears requesting you to confirm the settings change, click **Yes**.
11. After the Monitor Settings dialog box closes, click **OK**.
12. In the Display Properties dialog box, click **OK**.

This completes the procedure. Repeat these steps for any other computer whose screen resolution you wish to change.

## **Additional Mouse Synchronization Procedures**

If the mouse synchronization procedures mentioned in the manual fail to resolve mouse pointer problems for particular computers, try the following:

- 
- Note:** 1. These procedures are to be performed on the computers attached to the KL1508Ai / KL1516Ai's ports - not on the computer you are using to access the KL1508Ai / KL1516Ai.
2. In order for the local and remote mice to synchronize, you must use the generic mouse driver supplied with the Windows operating system. If you have a third party driver installed - such as one supplied by the mouse manufacturer - you must remove it.
- 

### **Windows:**

1. Windows 2000:
  - a) Open the Mouse Properties dialog box (Control Panel → Mouse → Mouse Properties)
  - b) Click the *Motion* tab
  - c) Set the mouse speed to the middle position (6 units in from the left)
  - d) Set the mouse acceleration to *None*

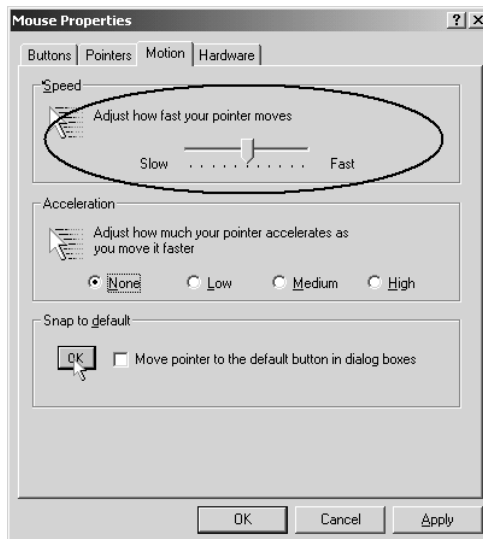

## 2. Windows XP / Windows Server 2003:

- a) Open the Mouse Properties dialog box (Control Panel → Mouse)
- b) Click the *Pointer Options* tab
- c) Set the mouse speed to the middle position (6 units in from the left)
- d) Disable *Enhance Pointer Precision*

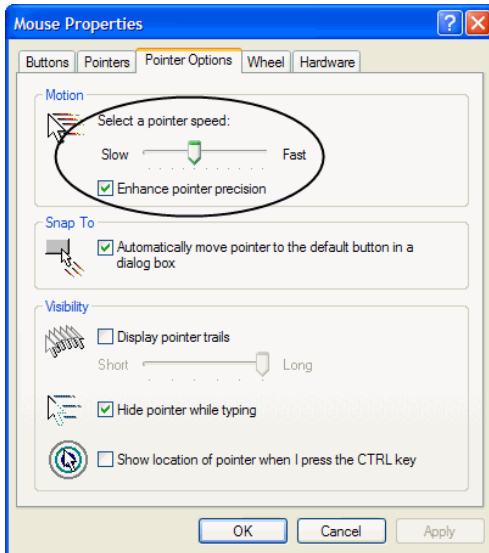

## 3. Windows ME:

Set the mouse speed to the middle position; disable mouse acceleration (click **Advanced** to get the dialog box for this).

## 4. Windows NT / Windows 98 / Windows 95:

Set the mouse speed to the slowest position.

**Sun / Linux:**

Open a terminal session and issue the following command:

Sun: `xset m 1`

Linux: `xset m 0`



## Connection Tables

---

The following table indicates the relationship between the number of compatible KVM Switch units and the number of computers that they control

### KL1508Ai

No.	Computers	No.	Computers
1	1 - 8	9	65 - 72
2	9 - 16	10	73 - 80
3	17 - 24	11	81 - 88
4	25 - 32	12	89 - 96
5	33 - 40	13	97 - 104
6	41 - 48	14	105 - 112
7	49- 56	15	113 - 120
8	57 - 64	16	121 - 128

### KL1516Ai

No.	Computers	No.	Computers
1	1 - 16	9	129 - 144
2	17 - 32	10	145 - 160
3	33 - 48	11	161 - 176
4	49 - 64	12	177 - 192
5	65 - 80	13	193 - 208
6	81 - 96	14	209 - 224
7	97- 112	15	225 - 240
8	113 - 128	16	241 - 256

## Supported Devices

---

The following table represents a list of supported devices that can be used on a KL1508Ai / KL1516Ai installation.

Type	
Daisy Chain Switches	KH0116, KH1508A; KH1516A; KH1508; KH1516; ACS1208A; ACS1216A; CS1708A; CS1716A
PON	PN0108
Central Control	CC2000

---

- Note:**
- ◆ To connect the KL1508Ai / KL1516Ai to a Power Over the NET™ unit, first use Cat 5e cable to connect the KL1508Ai / KL1516Ai's PON port to an SN0142 adapter; then, connect the adapter to the PON In port on the Power Over the NET™ unit.
  - ◆ For a more updated list of supported devices, visit the product webpage and refer to the Compatible Products / Cables / Accessories sections at the bottom of the page.
-

---

## Clear Login Information

---

If you are unable to log in as an Administrator (for example, corrupted or forgotten Username and Password) you can clear the login information with the following procedure.

---

**Note:** Performing this procedure also returns all settings to their defaults.

---

1. Power off the KL1508Ai / KL1516Ai and remove its housing.
2. Short the jumper labeled **J15**.

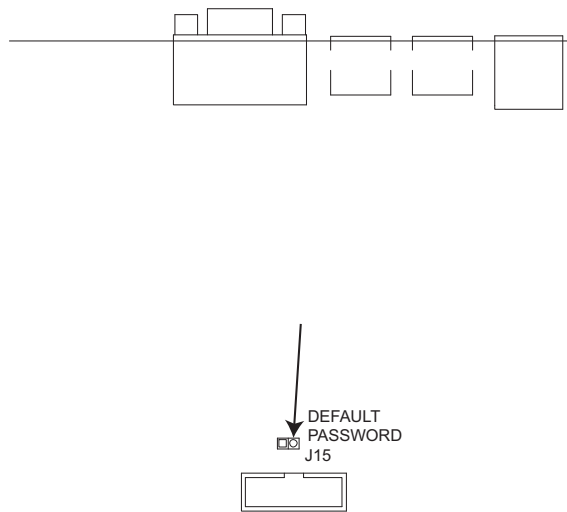

3. Power on the switch.  
The on screen display will show a message informing you that the password information has been cleared.
4. Power off the switch.
5. Remove the jumper cap from **J15**.
6. Close the housing and start the KL1508Ai / KL1516Ai back up.

After you start back up, you can use the default Username and Password (see *OSD Overview*, page 39) to log in.

## Dedicated Invocation Keys

---

Two dedicated keys are provided on the keyboard module to make it easy to invoke Hotkey Mode and the OSD (as shown in the diagram below):



---

**Note:** These keys are toggles. Press once to invoke the feature; press again to exit.

---

---

## OSD Factory Default Settings

---

The factory default settings are as follows:

Setting	Default
OSD Hotkey	[Scroll Lock] [Scroll Lock]
Port ID Display Position	Upper Left Corner
Port ID Display Duration	3 Seconds
Port ID Display Mode	The Port Number plus the Port Name
Scan Duration	5 Seconds
Scan/Skip Mode	All
Screen Blanker	OFF
Hotkey Command Mode	ON
Hotkey	[Num Lock] + [-]
Logout Timeout	OFF
Beeper	ON
OSD Language	English

## Limited Warranty

---

ATEN warrants its hardware in the country of purchase against flaws in materials and workmanship for a Warranty Period of two [2] years (warranty period may vary in certain regions/countries) commencing on the date of original purchase. This warranty period includes the LCD panel of ATEN LCD KVM switches. Select products are warranted for an additional year (see *A+ Warranty* for further details). Cables and accessories are not covered by the Standard Warranty.

### **What is covered by the Limited Hardware Warranty**

ATEN will provide a repair service, without charge, during the Warranty Period. If a product is defective, ATEN will, at its discretion, have the option to (1) repair said product with new or repaired components, or (2) replace the entire product with an identical product or with a similar product which fulfills the same function as the defective product. Replaced products assume the warranty of the original product for the remaining period or a period of 90 days, whichever is longer. When the products or components are replaced, the replacing articles shall become customer property and the replaced articles shall become the property of ATEN.

To learn more about our warranty policies, please visit our website:

<http://www.aten.com/global/en/legal/policies/warranty-policy/>