

# Assembly Instructions

## Spray Valve SMS-02

Article Number: S02-....

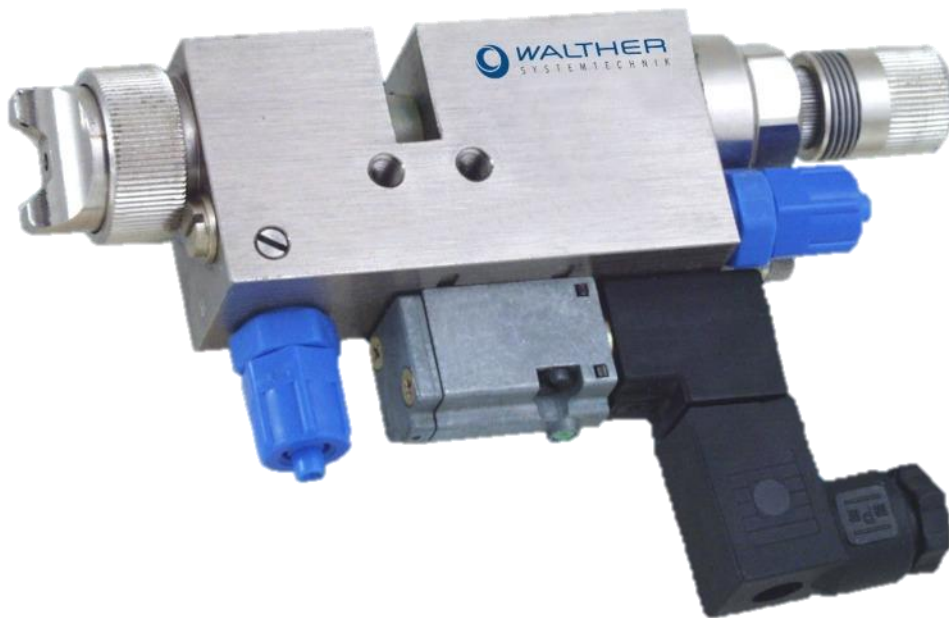

**Picture:** Spray Valve SMS-02 with flat air cap and raster-needle lock



### NOTE

Please read the Assembly Instructions carefully before first using the incomplete device and strictly adhere to the instructions!

The incomplete device may only be worked with and worked on by persons who are familiar with the assembly instructions and the current regulations for industrial safety and accident prevention.

**Always keep this translated version of the "Original Assembly Instructions" at the incomplete device! The instructions have to be available anytime!**

Table of Contents		Page
<b>EC DECLARATION OF INCORPORATION .....</b>		<b>4</b>
<b>1</b>	<b>INTRODUCTION .....</b>	<b>5</b>
1.1	TARGET GROUP OF THE ASSEMBLY INSTRUCTIONS .....	5
1.2	LIST OF SIGNS AND SYMBOLS .....	5
<b>2</b>	<b>SAFETY.....</b>	<b>5</b>
2.1	GENERAL INFORMATION .....	5
2.2	DANGERS FROM RESIDUAL ENERGY .....	5
2.3	WARRANTY AND LIABILITY .....	5
2.4	CORRECT USE .....	6
2.5	INCORRECT USE .....	6
2.6	QUALIFICATION OF PERSONNEL .....	6
<b>3</b>	<b>TRANSPORT.....</b>	<b>7</b>
3.1	PACKAGING .....	7
3.2	TASKS BEFORE TRANSPORT .....	7
<b>4</b>	<b>DESCRIPTION OF FUNCTION .....</b>	<b>7</b>
4.1	PURPOSE OF THE DEVICE.....	7
4.2	TECHNICAL DATA .....	8
4.3	TYPE LABEL .....	8
<b>5</b>	<b>INSTALLATION AND START-UP.....</b>	<b>8</b>
5.1	HOSE MOUNTING.....	8
5.2	TOTAL VIEW / DESCRIPTION.....	9
5.3	ADJUSTING THE DEVICE .....	9
5.4	SMS-02 WITH RASTER-NEEDLE DETECTION .....	10
5.4.1	<i>Terminal Assignment for Needle Query.....</i>	<i>10</i>
5.4.2	<i>Terminal Assignment for Magnetic Valve.....</i>	<i>10</i>
5.5	INSTALLATION DIAGRAM FOR COLOR-MARKING SYSTEMS.....	11
<b>6</b>	<b>OPERATION .....</b>	<b>11</b>
6.1	GENERAL INFORMATION .....	11
6.2	OPERATION INFORMATION / OPERATING CONDITIONS .....	11
6.3	OPERATING ELEMENTS .....	12
<b>7</b>	<b>MAINTENANCE AND REPAIR.....</b>	<b>13</b>
7.1	GENERAL INFORMATION .....	13
7.2	CLEANING .....	13
7.3	EXCHANGING THE AIR VALVE (11.0.0) .....	13
7.4	EXCHANGING THE RETURN CHECK VALVE, COMPLETE (10.0.0).....	13
7.5	REPLACING THE NEEDLE (7.0.0) AND THE NOZZLE (2.1.0).....	13
7.6	EXCHANGING THE SEALING BUSH (6.0.0) .....	14
7.7	INSERTING GASKETS AND O-RINGS: .....	14
7.8	MAINTENANCE FOR OPERATION IN COLOR-MARKING SYSTEMS (NORMAL OPERATION) .....	14
7.9	SPARE PARTS .....	15
7.10	CUSTOMER SERVICE / SUPPORT.....	15
<b>8</b>	<b>TROUBLESHOOTING .....</b>	<b>16</b>
8.1	GENERAL INFORMATION .....	16
8.2	FAILURES: .....	16
8.3	SPRAY IMAGE/ TYPE OF DEFECT .....	17
<b>9</b>	<b>TAKING OUT OF SERVICE .....</b>	<b>18</b>
9.1	SHORT INTERRUPTION .....	18
9.2	LONG-TERM INTERRUPTION.....	18

9.3	FINAL SHUTDOWN OF DEVICE .....	18
<b>10</b>	<b>APPENDIX.....</b>	<b>19</b>
10.1	DIMENSIONED DRAWING (FLAT JET) .....	19
10.2	DIMENSIONED DRAWING (ROUND JET) .....	19
10.3	SPARE PARTS DRAWING SMS-02 (STANDARD) .....	20
10.3.1	<i>Spare Part List for SMS-02 (Standard)</i> .....	21
10.4	SPARE PART DRAWINGS SMS-02 (RASTER-NEEDLE DETECTION) .....	22
10.4.1	<i>Spare Part List for SMS-02 (Raster-Needle Detection)</i> .....	23
10.5	ARTICLE NUMBERS FOR AIR CAPS .....	24
10.6	ARTICLE NUMBERS FOR NOZZLES .....	25
10.7	ARTICLE NUMBERS FOR NOZZLE NEEDLES.....	27
10.8	ARTICLE NUMBERS FOR VALVES .....	28
10.9	ARTICLE NUMBERS FOR THREADED JOINTS.....	29
10.10	ARTICLE NUMBERS FOR OTHER PARTS.....	29
10.11	WEAR-AND-TEAR PARTS .....	30
10.12	ACCESSORIES .....	31
10.12.1	<i>Center hole for Centering sleeve 97320602</i> .....	32
10.12.2	<i>Add-on Elements</i> .....	33
10.12.3	<i>Description Pneumatic Needle-Stroke Adjustment 97800037</i> .....	34

# EC Declaration of Incorporation

## in accordance with EU Machinery Directive 2006/42/EU, dated 17 May 2006, Appendix II B

We herewith confirm that the below mentioned incomplete device meets the basic requirements for safety and health as stated in EU Machinery Directive 2006/42/EU for its design and construction as well as for the configuration released by us on the market. This machine component will not be operated before it has been determined that the incomplete system where the machine component will be installed also meets the requirements of the Directive (2006/42/EG).

### Manufacturer

Walther Systemtechnik GmbH  
Hockenheimer Straße 3  
D- 76726 Germersheim

### Description

Spray Valve SMS-02, Article-No. S02-...

### We also declare the conformity with other, product-relevant directives/guidelines:

Mach. Direct. 2006/42/EU App. I, Clause: 1.1.2, 1.1.3, 1.1.5, 1.1.6, 1.3.2, 1.3.3,  
1.3.4, 1.5.1, 1.5.8, 1.5.9  
EMC- Directive 2014/30/EU, dated 26. February 2014

### Applied harmonized standards, in particular:

DIN EN ISO 12100

Safety of Machinery – General Design Principles –  
Risk Assessment and Risk Reduction (ISO  
12100:2010)

**In addition, we also confirm that the special documentation according to Appendix VII Part B has been prepared.**

The manufacturer, respectively his authorized representative obligates himself to submit this documentation to the market surveillance authorities, if requested.

This EC Declaration of Incorporation becomes invalid if the incomplete device will be altered or changed without consent of Walther Systemtechnik GmbH.

### Authorized representative for Technical Documentation:

Stefan Hirl, Hockenheimer Straße 3, D- 76726 Germersheim

Germersheim, 04 May 2018

(Place, Date)



(Stefan Hirl, Management)

# 1 Introduction

## 1.1 Target Group of the Assembly Instructions

- Operating Personnel
- Maintenance Personnel

## 1.2 List of Signs and Symbols

The assembly instructions warn users of operations which may put their health at risk. The warnings are indicated by combinations of text and symbols as follows:



### **DANGER**

Describes a potentially dangerous situation. Death, grievous bodily harm or severe material damage **WILL** occur if the respective measures of precaution have not been taken



### **WARNING**

Describes a potentially dangerous situation. Death, grievous bodily harm or severe material damage **MAY** occur if the respective measures of precaution have not been taken.



### **CAUTION**

Describes a potentially dangerous situation. Slight injuries **CAN** occur if the respective measures of precaution have not been taken. This signal word is also used to describe possible property damages.



### **IMPORTANT**

Indicates tips for usage and other particularly useful information. **No** dangerous situation.

## 2 Safety

### 2.1 General Information

The construction of this device is according to the latest technology and is absolutely reliable. The individual components as well as the complete device are continuously checked by our quality management.

### 2.2 Dangers from Residual Energy

Please instruct the operating personnel on the respective measures to be taken against the occurrence of mechanical, hydraulic, pneumatic and electric / electronic residual energies.

### 2.3 Warranty and Liability

According to the conditions laid down by the German Engineering Association (VDMA), Walther Systemtechnik GmbH has a guarantee of 12 months under normal European operating conditions on its own parts (spare parts are excluded); or according to the conditions of the manufacturer.

This guarantee can only be granted by Walther Systemtechnik GmbH, if:

- the user has thorough knowledge of the content of the assembly instructions;
- the user follows the instructions and notes contained in the assembly instructions;
- the user does not rebuild or make changes on parts of the device without prior consent of WST Systemtechnik GmbH.

## 2.4 Correct Use

This device is a needle valve and will be used for processing materials which can be sprayed in continuous or intermitting operation. Under no circumstances shall aggressive media such as acids, alkaline solutions, detergents, chemicals or others be sprayed. If you are not sure, please contact the manufacturer if a certain spray medium is suitable for this device.

## 2.5 Incorrect Use

- Operating the incomplete device with insufficient knowledge about the operation, maintenance and care of the device.
- Making changes, extensions or alterations on the incomplete device that may hamper its safety without the prior consent of Walther Systemtechnik GmbH.
- Operating the incomplete device with defective safety installations or not properly attached or malfunctioning safety devices.
- Using unsuitable materials.
- Handling the incomplete device while energized.

## 2.6 Qualification of Personnel

Only trained and instructed personnel may conduct work on the equipment.

The responsibilities of the personnel for assembly work, operation, repair work or maintenance work must be clearly assigned to individuals!

Persons in training may work with the equipment only under supervision of an experienced person.

Personnel Task	Instructed Personnel	Personnel with Technical Qualification	Specialist	Supervisor
Packaging, Transport	X	-	-	-
Commissioning	-	X	X	-
Operation	X	-	-	-
Troubleshooting, general	-	X	X	-
Troubleshooting mechanical	-	X	-	-
Troubleshooting electrical	-	-	X	-
Setting up	-	X	-	-
Maintenance	-	X	-	-
Repair	-	X	X	-
Taking out of service, Storage	-	X	X	-

## 3 Transport

### 3.1 Packaging

The type of packaging depends on the individual mode of shipping. If not separately contracted, the packaging is in accordance with the rules and regulations of Walther Systemtechnik GmbH.

### 3.2 Tasks before Transport

The following has to be done before transport:

- Disconnect all power lines.

The actual transport of the incomplete device and its individual parts requires special care in order to prevent damages from external forceful impact or careless on- and off-loading. Depending on the mode of transportation, suitable transport and load securing has to be selected. The incomplete device will be aligned and leveled by appropriate fastening elements.

## 4 Description of Function

The spray valves of **SMS-02** series are suitable for the application of liquid up to viscous media, such as grease, oil, separating agents, colors or glues. One of the major characteristics of SMS-02 series is the integrated spray air valve with which you can adjust the post-spray duration for cleaning the nozzles. Depending on the individual air cap, a round or flat jet is produced. And depending on the viscosity of the applicable medium, the application image can be adjusted individually via the nozzle size or the atomized air pressure or also the material pressure. Three different hoses are supplying atomized air, control air and medium.

### 4.1 Purpose of the Device



---

**CAUTION**

The use of other media can cause functional failures, damages or even the destruction of the device.

---

Spray valve SMS-02 is a pneumatically controlled application device for processing sprayable materials, such as glues, grease, colors etc. The control air lines were kept short due to a directly flanged 5/2-way magnetic valve (17.0.0) and they produce fast and very precise open/close movements of the needle (7.0.0). The working piston is firmly connected to the needle (7.0.0) and receives air pressure from the 5/2-way magnetic valve for the larger piston surface. This results in the opening movement of the needle. As soon as the air pressure on the larger surface of the working piston is turned off, the control air on the smaller surface of the working piston will initiate the closing movement.

During the operation, the closing spring (9.6.3) is disabled. This happens through the control air which is permanently pending on the smaller working surface and which also simultaneously compresses the closing spring (9.6.3) above the closing piston (9.8.3). Thereby the closing spring cannot hamper the fast switching times of the needle. The closing spring will only be operational in case of failure or turn-off of the compressed air supply. This will guarantee that no sprayable medium will be released during a defect in the air supply.

The device uses pre-supply/after-supply air (Setting-up of System, see also 6.3) for cleaning the nozzle (2.1.0).

The device is used for spraying applications. The material pressure has to correspond with the desired spray image and also with the atomizing air pressure. Spraying can be intermitting as well as continuous. The control air pulses will be transferred via the 5/2-way magnetic valve (17.0.0) to the working piston.

Depending on the individual case of operation, it is important to adapt the control air pressure to the switching frequency. For 5 intermissions already, this pressure has to be set to 5 bar.

## 4.2 Technical Data

### General Data

Size with flat-jet air cap [mm]	130 x 80 x 22
Size with round-jet air cap [mm]	127 x 80 x 22
Weight [g]	ca. 525
Material	Stainless steel 1.4301
Air consumption [l/min]	ca. 150 (at 3 bar; nozzle-Ø 1.0 mm and flat-jet)
Switching time [ms]	ca. 100 (for color marking systems ca. 200)

### Energy Supply

Control air pressure [bar]	4.5-6
Atomizer air pressure [bar]	0.5 – 5 (at least 0.5 bar lower than control pressure)
Material pressure [bar]	max. 35
Voltage [VDC]	24
Power consumption [W]	1,8

## 4.3 Type Label

The type label was etched into the casing. The serial number is hammered into this label.

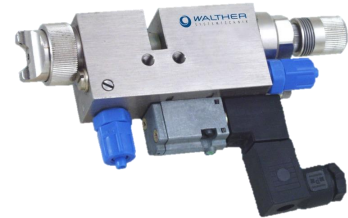

## 5 Installation and Start-up

The valves can be installed in any position. The distance to the application area depends on the desired application width. An intermitting operation of the device will cause natural oscillations; therefore a solid installation is most important. Try to avoid excessive natural oscillations (transmission from device to valve).

### 5.1 Hose Mounting

There are three functional hoses which will be connected as follows:

- 1 Material to G 1/8-connection (matching screw connections can be ordered as accessories!)
- 2 Control air SL to screw connection for 6mm-hose (21.0.0)
- 3 Atomizer air ZL to screw connection for 6mm-hose (21.1.0)

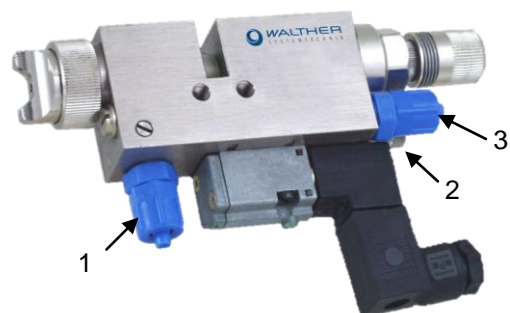



## 5.2 Total View / Description

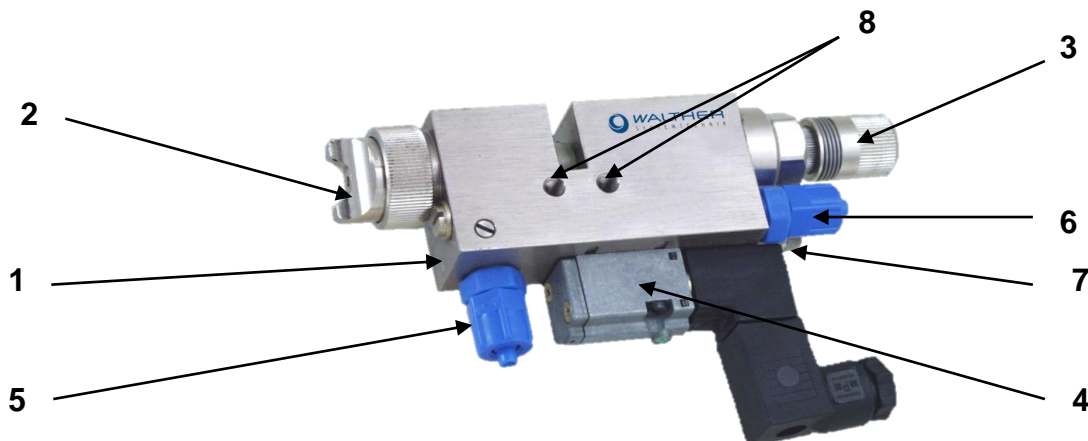

1	Basic casing
2	Nozzle with air cap and retainer ring
3	Raster needle lock
4	5/2-way magnetic valve
5	Material connection
6	Connection for atomizer air
7	Connection for control air
8	2x Fastening thread M5

## 5.3 Adjusting the Device

The stroke adjustment of the needle (Pos. 7.0) will be used for setting the material quantity. A left turn of the raster-needle locking screw will increase the material quantity. A finely ascending precision thread results in a needle stroke which changes 0.5mm with one turn of the raster head.



### IMPORTANT

The maximum turn of the raster-needle locking screw anti-clockwise should not exceed the noticeable raster steps. This will already exceed the maximum needle stroke adjustment. If you continue turning, the raster-needle locking screw will be dislocated!



### IMPORTANT

Nozzle and nozzle needle can be damaged by wrong treatment. Only reduce the material flow with emerging material (right turn of adjusting screw). Do not turn adjusting screw further to the right after closing of the nozzle!



### NOTE

The duration of the after-supply air will be individually set from the outside at the spray valve. The adjusting screw (10.4.0) is flush-mounted at the side and will be turned (in spray direction: to the right) with a screwdriver in order to adjust the duration of the after-supply air as follows.

- ↻ right turn = longer after-supply air duration
- ↻ left turn = shorter after-supply air duration
- Basic setting = screw flush-mounted with basic body; then one turn to the right

### 5.4 SMS-02 with Raster-Needle Detection

Optionally, you can use a raster-needle lock with a pre-installed, inductive proximity switch. It will release a signal when the needle piston with the needle is open. This will help you in digitally monitoring the status „nozzle open“.

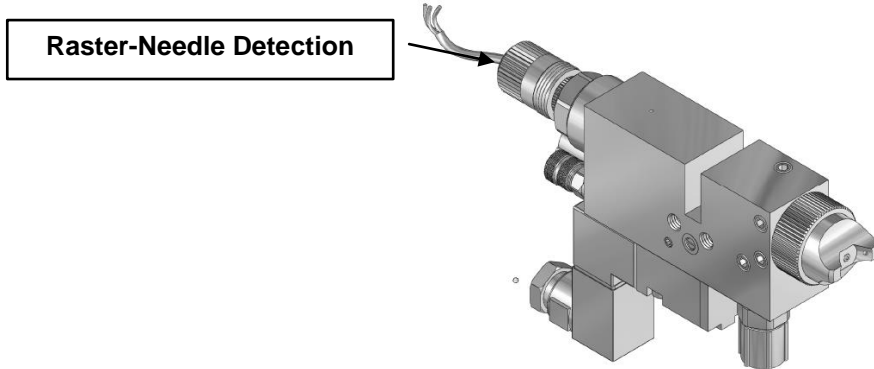

#### 5.4.1 Terminal Assignment for Needle Query

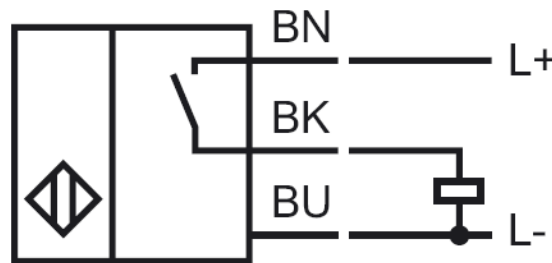

#### 5.4.2 Terminal Assignment for Magnetic Valve

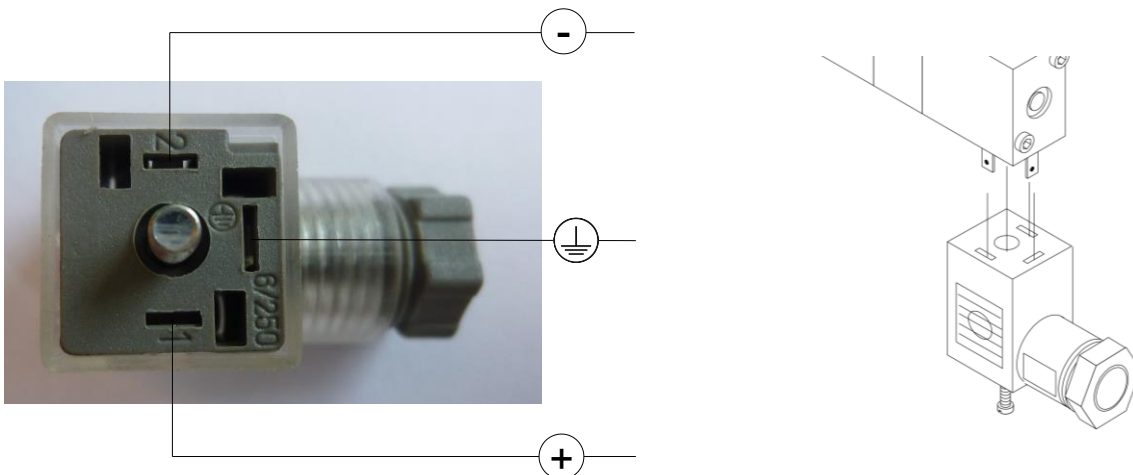

Standard plug 24V valve (left [+] and right [-])

## 5.5 Installation Diagram for Color-Marking Systems

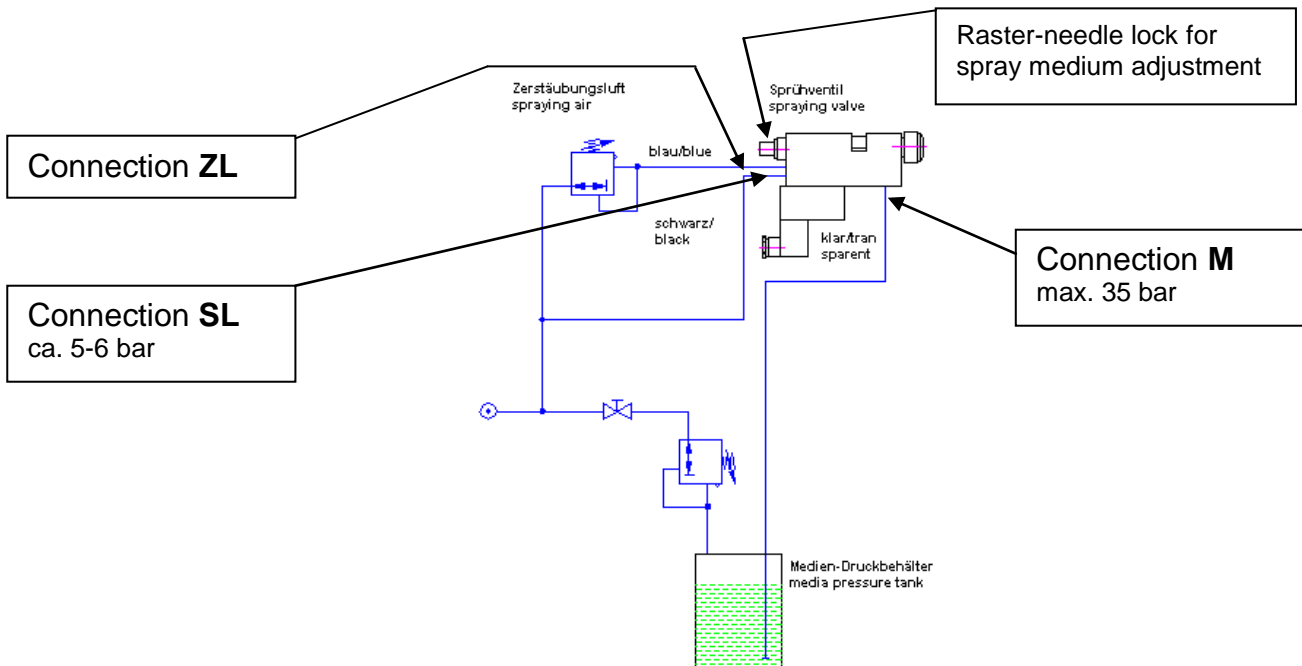

## 6 Operation

### 6.1 General Information

This device may only be operated if the safety-related equipment is permanently effective and not suspended during operation or altered in its intended effectiveness.

### 6.2 Operation Information / Operating Conditions



#### CAUTION

Never point the jet at people. The wearing of eye protection is strongly recommended. The spraying process can create noise depending on the air and fluid pressures used. Ear protection should be worn, if required.



#### WARNING

Danger caused by flammable, harmful fluid. Always follow the safety instructions on the container or the safety data sheet for the fluid.

Spray valves of the **SMS-02** series generally operates with a control pressure of 5 - 6 bar. The atomizer pressure has to be lower than the material pressure in order to avoid a repulse of the material. Atomized air pressure and material pressure should be closely correlated.



#### IMPORTANT

Accident prevention directions will be **strictly** followed when applying high material pressures. Please strictly follow the following instructions when planning and constructing application systems!

- Each spraying valve must be equipped with its own pressure regulator for atomizing air.
- In case several spraying valves are supplied by one and the same material pressure tank, these valves must not spray simultaneously.
- The supply route for the material between material pressure tank and spraying valve must not exceed 2 m.

- If the pause time is a multiple of the spray time, the valve must be sprayed free in a separate location or the spray valve should be operated several times to optimize the application.
- After standstills of 15 min. and more, the valve must be sprayed free by pressing the switch 3 to 5 times.

The application can be controlled as intermitting or continuous. Depending on the individual use, the control pressure has to be adjusted to the set switching frequency on the one hand and to the higher or lower material pressures on the other. Under appropriate operating conditions (material pressure, control pressure, needle stroke, and short supply lines) a total of 50 strokes per second can be reached.

#### IMPORTANT



A device-specific set-up is required for an optimum adjustment of the application image. Basic results from lab tests can be used. Of course, these may have to be adjusted for the individual device. The parameters nozzle size, opening time, opening stroke, material pressure and if required, also temperature have to be combined.

For longer standstills, the material can remain in the valve, if it remains under pressure (no contact to outside air).

### 6.3 Operating Elements

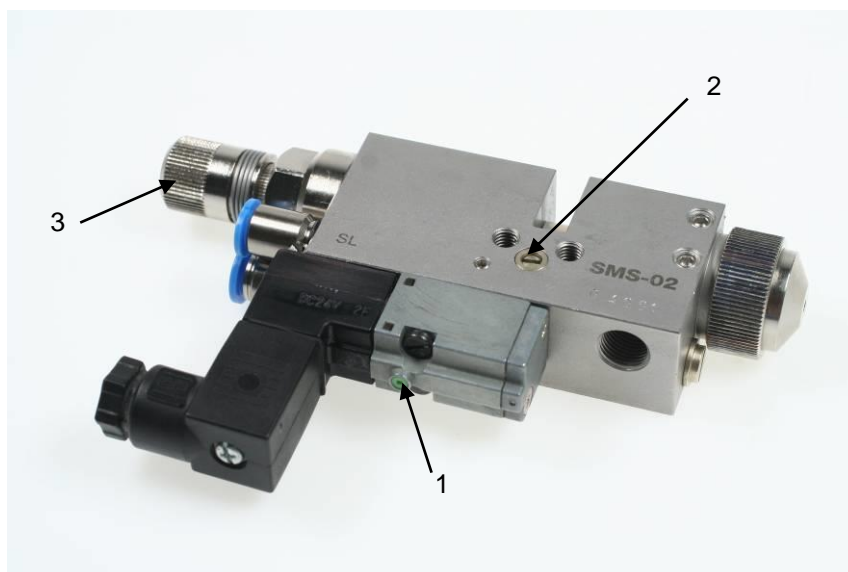

1	Manual release at magnetic valve (green button)
2	Adjusting screw for adjusting the after-supply air
3	Adjusting button for the raster-needle adjustment

## 7 Maintenance and Repair

### 7.1 General Information

The spray valves of the **SMS-02** series are high-quality precision devices which will not fail if treated correctly and will operate almost maintenance-free. All mobile parts should be regularly oiled and also the threads should be greased when the nozzles are cleaned or exchanged. Always keep clean and observe minimum instructions to maintain a long life of the valve. Always use clean and filtered material only. The control air must also be clean, if necessary. Maintenance also depends on the individual operating conditions and the type of media used.



#### CAUTION

Before starting any maintenance or repair work, ensure that all air-operated tools are depressurized and disconnected from the air supply.

Before opening the spray valve it must be disconnected from the air and fluid supply. Otherwise, ejected components can cause injuries.

### 7.2 Cleaning



#### IMPORTANT

Only use soft brushes for outside cleaning of the nozzle tips. Never use metal tools with sharp edges.

Wash equipment thoroughly after use to remove residues and dirt, especially if needle (Pos.7.0.70), or sealing sleeve (6.1.0) or material nozzle (Pos.2.1.0) have to be exchanged.

### 7.3 Exchanging the Air Valve (11.0.0)

- Unscrew locking screw (11.1.0)
- Remove spring (11.3.0)
- Pull out locking piston (11.2.0)
- Exchange O-rings (11.1.1 + 11.2.1) if necessary
- Slightly grease and re-assemble in reverse sequence.

### 7.4 Exchanging the Return Check Valve, complete (10.0.0)

- Unscrew locking screw (10.4.0)
- Unscrew fastening thread pin (10.6.0)
- Use a screw (M3) of sufficient length and screw it in instead of adjusting screw (10.4.0) in order to carefully pull out the basic casing (10.1.0)
- If necessary, also exchange the reversing sleeve (10.5.0) and the O-ring (10.2.0) as well as the O-ring (10.3.0) on the unscrewed adjusting screw (10.4.0).
- Slightly grease and re-assemble in reverse sequence.

### 7.5 Replacing the Needle (7.0.0) and the Nozzle (2.1.0)

- Completely unscrew raster-needle lock (9.0.3)
- Remove air cap (1.1.0) with retainer ring (3.1.0)
- Unscrew nozzle (2.1.0)
- Carefully push needle (7.0.0) from the nozzle side to the back
- Re-assemble new, slightly greased parts in reverse order.



#### IMPORTANT

Nozzle set = Nozzle needle, nozzle and air cap (should always be replaced at the same time)!

We do not recommend employing used needles. Leakages are caused by pricking needles which are not completely clean through the shaped sealing (5.1.0).

## 7.6 Exchanging the Sealing Bush (6.0.0)

- Unscrew raster-needle lock completely (9.0.3)
- Remove air cap (1.1.0) with retainer ring (3.1.0)
- Unscrew nozzle (2.1.0)
- Carefully push needle (7.0.0) from the nozzle side to the back
- Then use a screwdriver to unscrew sealing bush (6.0.0) from the thread.

### IMPORTANT



Due to the outside O-ring (5.3.0), the sealing sleeve cannot easily fall through the fastening thread of the main body (4.1.0). Therefore an additional small strip of sheet metal (0.5 – 1.0 mm) will be slid between the body gap and flat towards the front end of the sealing sleeve. Then you can carefully push the sealing sleeve together with the O-ring (5.3.0) to the back of the thread. Now the sealing sleeve can be easily removed from the casing.

## 7.7 Inserting Gaskets and O-Rings:

If you do not have a complete sealing sleeve (6.0.0) with integrated material sealing kit (5.0.0) available as replacement, you have to remove the old gaskets and replace them by new ones. For this purpose, you have to clean the sealing sleeve so that no residues from sprayed medium will hamper the installation of the new gaskets. Slightly grease the O-ring holders with a lubricant (technical petrolatum).

- First insert the O-ring (6.2.0) into the back boring to the bottom of the sealing sleeve.
- Then insert the O-ring (5.3.0) into the outer groove.
- Insert the shaped sealing (5.1.0) into the front holder. This shaped sealing is not symmetrical. Make sure that the side with the larger boring points to the front when inserting it; it has to point towards the nozzle after the installation of the complete sealing sleeve.
- Slightly grease the complete sealing sleeve (6.0.0) and move it back into the main body (4.1.0); do not turn when pushing it carefully through the fastening thread together with the outside O-ring (5.3.0), using a screwdriver.
- After that screw the sealing sleeve into the thread (slightly tighten).

### IMPORTANT



Do not use any metal or sharp-edged equipment or tools when inserting the O-rings and the shaped sealing. The shaped sealing in particular is a very precise and sensitive part which has outstanding sealing characteristics and should therefore not be hit or pressed.

## 7.8 Maintenance for Operation in Color-Marking Systems (Normal Operation)

The spray cap will be cleaned every other day with a special thinner and a soft cloth. Make sure that no cloth fibers are left on the nozzle tip.

The material section of the spray valve should be cleaned with a special thinner every other week. Please observe the following steps:

- Needle lock (9.0.3) completely open (remember raster setting for later use!)
- Remove air cap (1.1.0/x) and unscrew nozzle (2.1.0) with a SW 6 open wrench.

### IMPORTANT



Hold spray valve downwards so that no medium can flow into the air channels. Discharged medium will be collected in a container and disposed of later.

- Clean with a soft (paint-)brush and a special thinner.
- Re-assemble nozzle and air cap after cleaning.
- Re-set the raster-needle setting.

A cleaning cycle will be initiated after standstills (e.g. breaks over night or on weekends). The nozzle will be sprayed clean. This cleaning cycle will be activated through the system controls.

### IMPORTANT



Use a dummy or a cloth during the cleaning cycle in order to avoid soiling!

- After longer system standstills (e.g. 2-3 weeks), the complete system will be cleaned before re-start. If necessary, the material hoses and if applicable, also the inlays of the pressure tank have to be replaced.
- The material pressure container will be opened every week and the color will be thoroughly stirred (if no agitator is provided).
- The material pressure container will be cleaned every 3-4 months; material lines and inlays will be exchanged.



---

**IMPORTANT**

Clean the complete system every six months!

---

## 7.9 Spare Parts



---

**IMPORTANT**

**Only use original spare parts from the manufacturer!**

Wrong or defective spare parts from other manufacturers can damage the device. If other than original spare parts of the manufacturer will be used, all obligations from the manufacturer or his sales partners, such as guarantees, service contracts etc will be **forfeited** without further notice.

---

## 7.10 Customer Service / Support

**Walther Systemtechnik GmbH**

Hockenheimer Straße 3

D-76726 Germersheim

Germany

Phone ++49(0)7274-7022-0

Fax ++49(0)7274-7022-91

Email [info@walther-2000.de](mailto:info@walther-2000.de)

Internet [www.walther-2000.de](http://www.walther-2000.de)

## 8 Troubleshooting

### 8.1 General Information



#### IMPORTANT

First check all supply lines for connection and serviceability.







In case of serious problems that cannot be resolved, please contact the Walther Systemtechnik GmbH customer service.

### 8.2 Failures:

Fault	Possible Cause	Action
Nozzle needle does not open.	No electrical current (slight clicking-sound at the magnetic valve )	Check electrical power supply
	Not enough control air pressure	Check control air pressure (make sure it set to 5-6 bar)
	Leakages	Check O-ring (6.2.0), O-ring (7.4.0) or O-ring (7.5.0) and replace if necessary
	Needle (7.0.0) is sticky within the needle sealing screw (6.1.0)	Disassemble and clean
	Needle stroke is set too low	Turn left at raster-needle setting for proper setting
Pre-supply/After-supply air is constantly blowing	Adjusting screw (10.4.0) was screwed in too deep	Move adjusting screw back to basic setting (see 4.3)
	Locking piston (11.2.0) not suitable for atomizer air pressure	Replace air valve (11.0.0) completely (see spare parts list)
	O-ring (11.2.1) on locking piston defective	Replace O-ring
Medium leaks at slot (covered by plastic protection sleeve 5.4.0)	Leakage of material sealing	Complete overhaul of spray valve



### 8.3 Spray Image/ Type of defect

SPRAY IMAGE	PROBLEM	CAUSE	ACTION
		Normal Spray Image (Flat jet)	
		Normal Spray Image (Round jet)	
	Spray image shaped too much upwards and downwards	Soiled air cap Soiled nozzle	Clean nozzles
	Spray image too much left-sided or right-sided	Soiled air cap Soiled nozzle	Clean nozzles
	Heavy application in the middle of the spray image	Too much material Material too thick	Reduce material supply Dilute material
	Split spray image	Too little material Pressure flat jet too high	Increase material supply Increase pressure for round jet

## 9 Taking out of Service

### 9.1 Short Interruption

A short interruption (15 min or more) has to be followed by a fine spraying.



---

**IMPORTANT**

Please follow the Operating Manual!

---

### 9.2 Long-term Interruption

The following has to be observed for a long-term interruption of the device/machine:

- Depressurize material supply lines
- Take off air cap (1.1) and clean nozzle (2.1) with a special thinner and a soft cloth. Make sure that no cloth fibers are left on the nozzle tip.



---

**IMPORTANT**

Please follow the maintenance instructions!

---

### 9.3 Final Shutdown of Device

The following is important for a shutdown of the machine / device:

- Clean spray valve with a special thinner.



---

**IMPORTANT**

Please follow the maintenance instructions!

---

## 10 Appendix

### 10.1 Dimensioned Drawing (Flat jet)

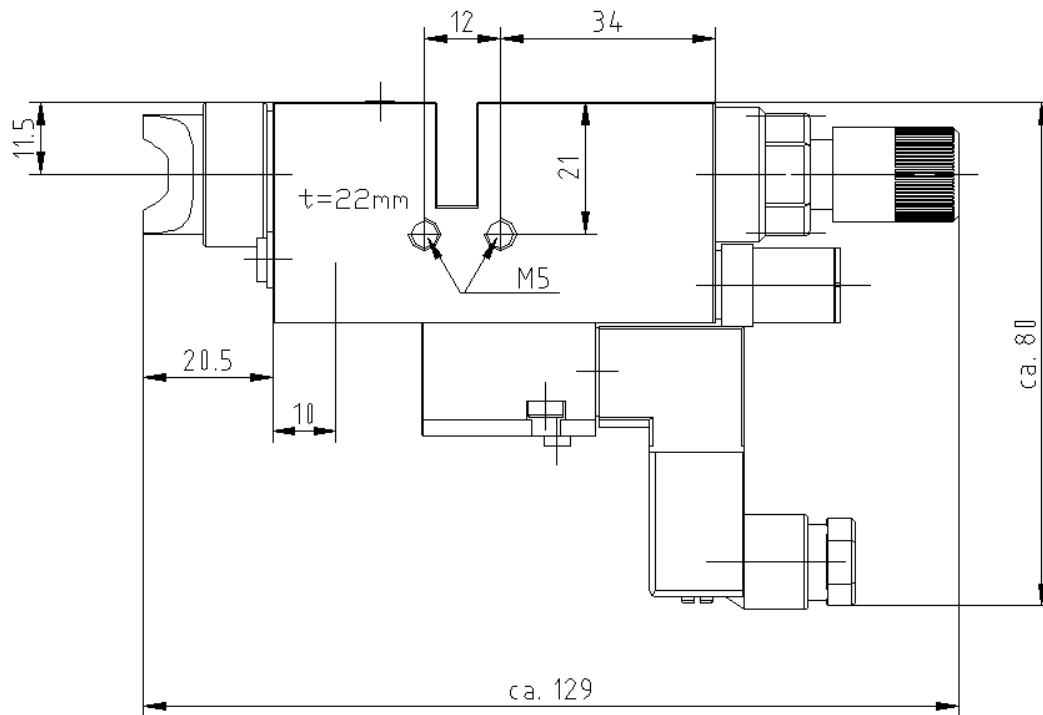

### 10.2 Dimensioned Drawing (Round jet)

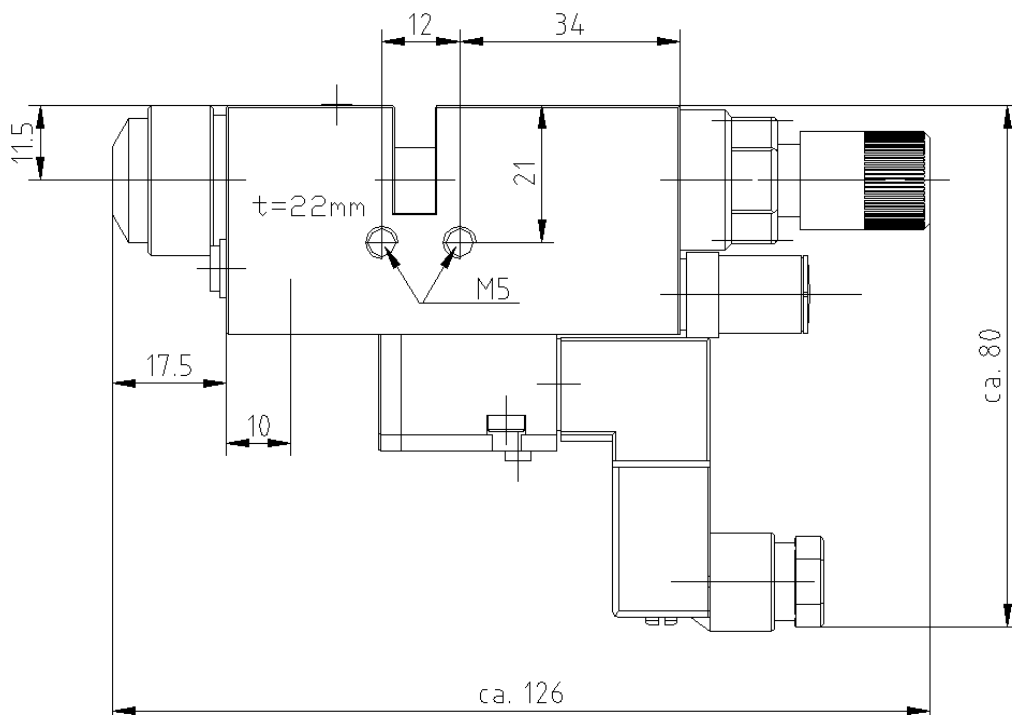

### 10.3 Spare Parts Drawing SMS-02 (Standard)

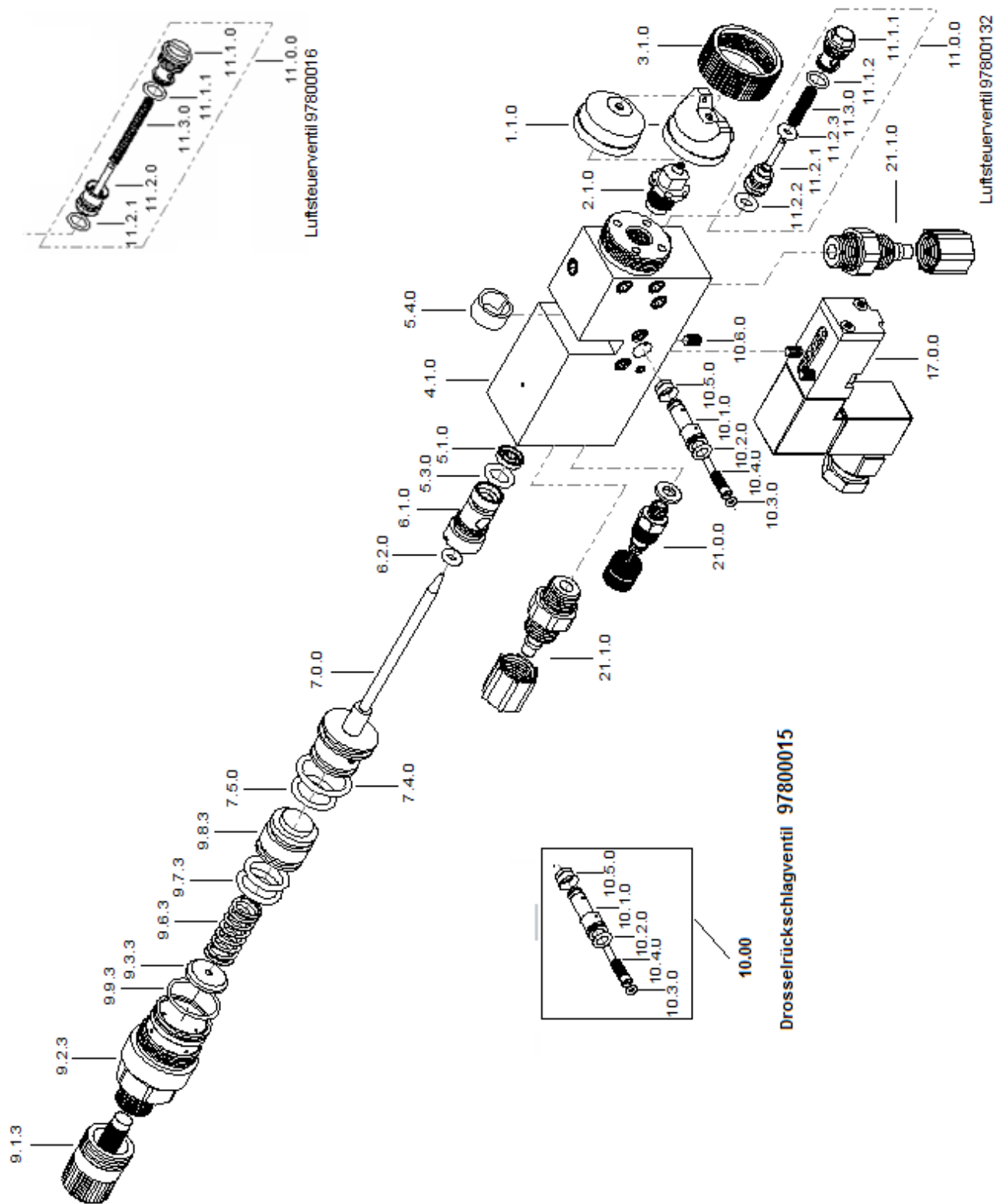

**IMPORTANT**

Air control valve and return check valve are available only as complete!

### 10.3.1 Spare Part List for SMS-02 (Standard)

Pos.	Article-No.	Qty	Description	VITON	EPDM	ISOLAST
1.1.0	*	1	Air cap	X	X	X
2.1.0	*	1	Nozzle	X	X	X
3.1.0	97410028	1	Retainer ring	X	X	X
4.1.0	97510030	1	Main body	X	X	X
5.0.0	979504.000	1	<i>Material wear-and-tear set complete</i>	X		
5.0.0	979504.001	1	<i>Material wear-and-tear set complete</i>		X	
5.0.0	979504.002	1	<i>Material wear-and-tear set complete</i>			X
6.0.0	97810014	1	Sealing screw complete (Pos. 6.1.0/6.2.0)	X		
6.0.0	97810026	1	Sealing screw complete (Pos. 6.1.0/6.2.0)		X	
6.0.0	97810028	1	Sealing screw complete (Pos. 6.1.0/6.2.0)			X
7.0.0	*	1	Nozzle needle complete	X	X	X
7.4.0	97640007	1	O-ring 14.00 x 1.78mm	X	X	X
7.5.0	97640005	1	O-ring 10.82 x 1.78	X	X	X
9.0.0	97900004	1	Raster-needle lock complete	X	X	X
9.1.3	97610092	1	Needle-stroke raster head	X	X	X
9.2.3	97220092	1	Raster locking screw	X	X	X
9.3.3	97930000	1	Pressure disk	X	X	X
9.6.3	97820020	1	Pressure spring	X	X	X
9.7.3	97640005	2	O-ring 10.82 x 1.78	X	X	X
9.8.3	97710005	1	Locking piston	X	X	X
9.9.3	97640043	1	O-ring 15 x 1	X	X	X
10.0.0	97800015	1	Return check valve complete	X	X	X
11.0.0	*	1	Air control valve complete	X	X	X
17.0.0	*	1	Magnetic valve 5/2-way	X	X	X
21.0.0	*	1	Threaded joint	X	X	X
21.1.0	*	1	Straight threaded joint G 1/8	X	X	X
21.2.0	*	1	Straight threaded joint G 1/8	X	X	X

\* Please see the following pages for article numbers.



#### IMPORTANT

Always indicate the inscribed serial numbers when ordering spare parts!

### 10.4 Spare Part Drawings SMS-02 (Raster-Needle Detection)

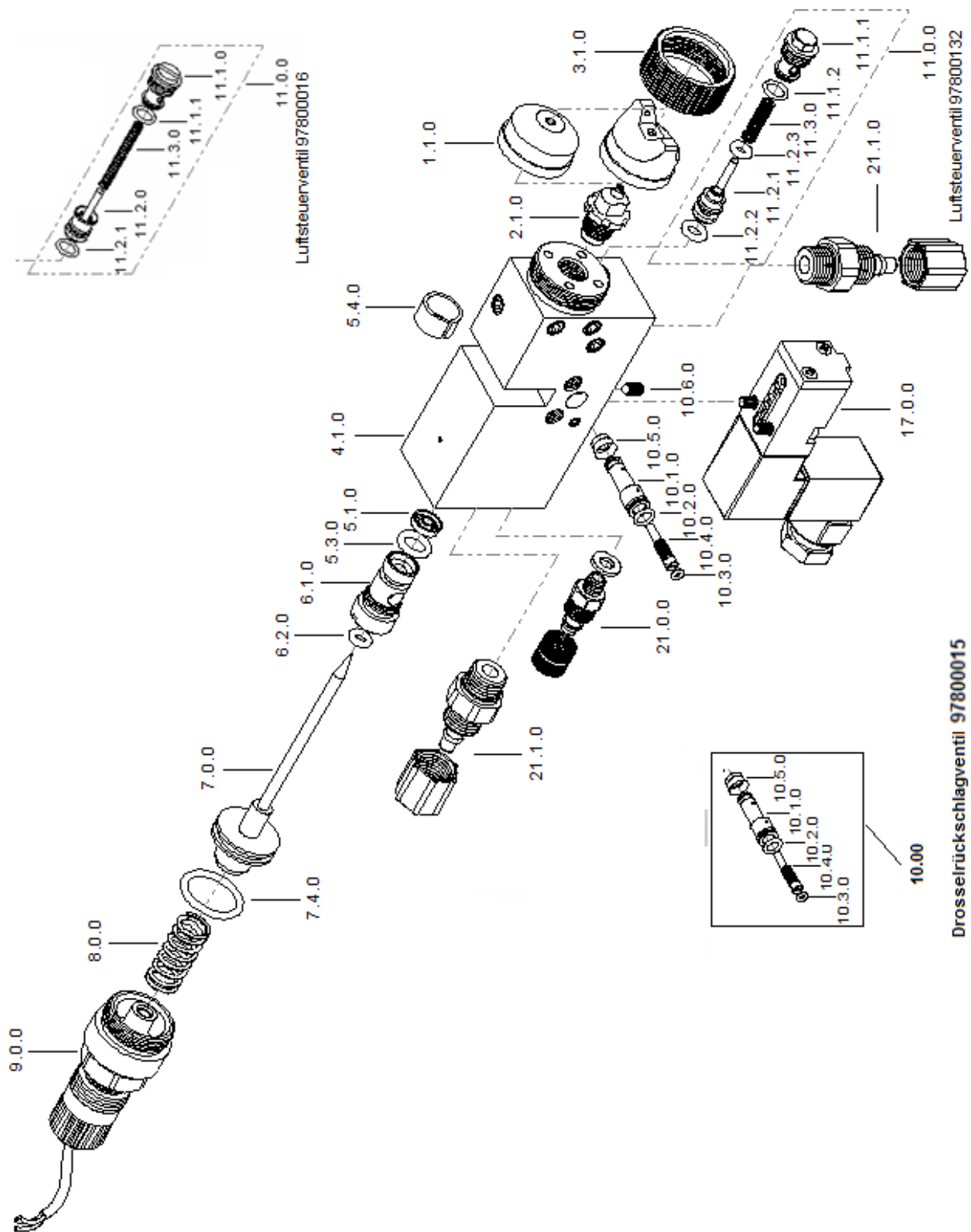

**IMPORTANT**

Air control valve and return check valve are available only as complete!

### 10.4.1 Spare Part List for SMS-02 (Raster-Needle Detection)

Pos.	Article-No.	Qty	Description	VITON	EPDM	ISOLAST
1.1.0	*	1	Air cap	X	X	X
2.1.0	*	1	Nozzle	X	X	X
3.1.0	97410028	1	Retainer ring	X	X	X
4.1.0	97510590	1	Main body	X	X	X
5.0.0	979504.000	1	<i>Material wear-and-tear set complete</i>	X		
5.0.0	979504.001	1	<i>Material wear-and-tear set complete</i>		X	
5.0.0	979504.002	1	<i>Material wear-and-tear set complete</i>			X
6.0.0	97810014	1	<i>Sealing screw complete (Pos. 6.1.0/6.2.0)</i>	X		
6.0.0	97810026	1	<i>Sealing screw complete (Pos. 6.1.0/6.2.0)</i>		X	
6.0.0	97810028	1	<i>Sealing screw complete (Pos. 6.1.0/6.2.0)</i>			X
7.0.0	*	1	Nozzle needle complete	X	X	X
7.4.0	97640007	1	O-ring 14.00 x 1.78mm	X	X	X
8.0.0	97820090	1	Pressure spring	X	X	X
9.0.0	97900033	1	Raster-needle lock complete	X	X	X
10.0.0	97800015	1	Return check valve complete	X	X	X
11.0.0	*	1	Air control valve complete	X	X	X
17.0.0	*	1	Magnetic valve 5/2-way	X	X	X
21.0.0	*	1	Threaded joint	X	X	X
21.1.0	*	1	Straight threaded joint G 1/8	X	X	X
21.2.0	*	1	Straight threaded joint G 1/8	X	X	X

\* Please see the following pages for article numbers.



#### IMPORTANT

Always indicate the inscribed serial numbers when ordering spare parts!

## 10.5 Article Numbers for Air Caps





<b>1.1.0</b>	<b><i>Air cap, Flat jet, Standard, 45° (Ø20x14.5mm)</i></b>	
<b>Article-No.</b>	<b>Description</b>	
97310038	Air cap, Flat jet, 0.2-1.0mm	
97310039	Air cap, Flat jet, 1.2-1.5mm	
97310231	Air cap, Flat jet, 1.8-2.0mm	
<b>1.1.0</b>	<b><i>Air cap, Flat jet, Standard, 60° (Ø20x14.5mm)</i></b>	
<b>Article-No.</b>	<b>Description</b>	
97310032	Air cap, Flat jet, 0.2-1.0mm	
97310033	Air cap, Flat jet, 1.2-1.5mm	
97310079	Air cap, Flat jet, 1.8-2.0mm	
97310090	Air cap, Flat jet, 2.5mm	
<b>1.1.0</b>	<b><i>Air cap, Flat jet, Standard, 90° (Ø20x14.5mm)</i></b>	
<b>Article-No.</b>	<b>Description</b>	
97310036	Air cap, Flat jet, 0.2-1.0mm	
97310037	Air cap, Flat jet, 1.2-1.5mm	
97310166	Air cap, Flat jet, 1.8-2.0mm	
97310167	Air cap, Flat jet, 2.5mm	
<b>1.1.0</b>	<b><i>Air cap, Flat jet, KLS, 45° (Ø20x14.5mm)</i></b>	
<b>Article-No.</b>	<b>Description</b>	
97310292	Air cap, Flat jet, KLS 0.2-1.0mm	
97310546	Air cap, Flat jet, KLS 1.2-1.5mm	
97310547	Air cap, Flat jet, KLS 1.8-2.0mm	
<b>1.1.0</b>	<b><i>Air cap, Flat jet, KLS, 60° (Ø20x14.5mm)</i></b>	
<b>Article-No.</b>	<b>Description</b>	
97310081	Air cap, Flat jet, KLS 0.2-1.0mm	
97310082	Air cap, Flat jet, KLS 1.2-1.5mm	
97310083	Air cap, Flat jet, KLS 1.8-2.0mm	
97310608	Air cap, Flat jet, KLS 2.5mm	
<b>1.1.0</b>	<b><i>Air cap, Flat jet, KLS, 90° (Ø20x14.5mm)</i></b>	
<b>Article-No.</b>	<b>Description</b>	
97310108	Air cap, Flat jet, KLS 0.2-1.0mm	
97310211	Air cap, Flat jet, KLS 1.2-1.5mm	
97310545	Air cap, Flat jet, KLS 1.8-2.0mm	



<b>1.1.0</b>	<b><i>Air cap, Round jet, Standard, 15° (Ø20x11mm)</i></b>	
<b>Article-No.</b>	<b>Description</b>	
97310034	Air cap, Round jet, 0.2-1.0mm	
97310035	Air cap, Round jet, 1.2-1.5mm	
97310080	Air cap, Round jet, 1.8-2.0mm	
97310091	Air cap, Round jet, 2.5mm	
<b>1.1.0</b>	<b><i>Air cap, Round jet, KLS, 15° (Ø20x11mm)</i></b>	
<b>Article-No.</b>	<b>Description</b>	
97310084	Air cap, Round jet, KLS 0.2-1.0mm	
97310085	Air cap, Round jet, KLS 1.2-1.5mm	
97310086	Air cap, Round jet, KLS 1.8-2.0mm	
97310250	Air cap, Round jet, KLS 2.5mm	
<b>1.1.0</b>	<b><i>Marking Air cap, Round jet 8° (Ø20x18mm)</i></b>	
<b>Article-No.</b>	<b>Description</b>	
97310578	Marking air cap, 0.2-0.5mm	
97310727	Marking air cap, 0.8-1.0mm	
<b>1.1.0</b>	<b><i>Special spin air cap, round jet</i></b>	
<b>Article No.</b>	<b>Description</b>	
97310197	Special spin 0.2-2.0mm	

## 10.6 Article Numbers for Nozzles

<b>2.1.0</b>	<b><i>Nozzle, Standard, stainless steel (Ø12x18mm)</i></b>	
<b>Article-No.</b>	<b>Description</b>	
97210110	Nozzle, Standard, 0.2mm	
97210111	Nozzle, Standard, 0.3mm	
97210112	Nozzle, Standard, 0.5mm	
97210113	Nozzle, Standard, 0.8mm	
97210114	Nozzle, Standard, 1.0mm	
97210115	Nozzle, Standard, 1.2mm	
97210116	Nozzle, Standard, 1.5mm	
97210117	Nozzle, Standard, 2.0mm	
97210118	Nozzle, Standard, 2.5mm	

<b>2.1.0</b>	<b>Nozzle, KLS, stainless steel (Ø 12x17.2mm)</b>	
<b>Article-No.</b>	<b>Description</b>	
97210119	Nozzle, KLS, 0.2mm	
97210120	Nozzle, KLS, 0.3mm	
97210121	Nozzle, KLS, 0.5mm	
97210122	Nozzle, KLS, 0.8mm	
97210123	Nozzle, KLS, 1.0mm	
97210124	Nozzle, KLS, 1.2mm	
97210125	Nozzle, KLS, 1.5mm	
97210126	Nozzle, KLS, 2.0mm	
97210564	Nozzle, KLS, 2.5mm	
<b>2.1.0</b>	<b>Nozzle, KLS/K (hardened by Kolsterising), stainless steel (Ø 12x17.2mm)</b>	
<b>Article-No.</b>	<b>Description</b>	
97212156	Nozzle, KLS/K, 0.2mm	
97212756	Nozzle, KLS/K, 0.3mm	
97211468	Nozzle, KLS/K, 0.5mm	
97211113	Nozzle, KLS/K, 0.8mm	
97211469	Nozzle, KLS/K, 1.0mm	
97212328	Nozzle, KLS/K, 1.5mm	
97211898	Nozzle, KLS/K, 2.0mm	
<b>2.1.0</b>	<b>Nozzle, KLS, spin, stainl.-steel 30° (Ø 12x17,3mm)</b>	
<b>Article-No.</b>	<b>Description</b>	
97210805	Nozzle, KLS, 0.3mm	
97210806	Nozzle, KLS, 0.5mm	
97210807	Nozzle, KLS, 0.8mm	
97210808	Nozzle, KLS, 1.0mm	
97211391	Nozzle, KLS, 1.2mm	
97210809	Nozzle, KLS, 1.5mm	
97210810	Nozzle, KLS, 2.0mm	
97211467	Nozzle, KLS, 2.5mm	
<b>2.1.0</b>	<b>Marking nozzle, stainless steel 8°(Ø8x18mm)</b>	
<b>Article-No.</b>	<b>Description</b>	
97212055	Marking nozzle 0.2mm	
97211875	Marking nozzle 0.3mm	
97212025	Marking nozzle 0.4mm	
97211461	Marking nozzle 0.5mm	
97212146	Marking nozzle 0.8mm	

2.1.0	<b>Nozzle, special spin, stainless steel (Ø 12x18mm)</b>	
Article No.	Description	
97210483	Nozzle, special spin, 0.2mm	
97210484	Nozzle, special spin, 0.3mm	
97210482	Nozzle, special spin, 0.5mm	
97210485	Nozzle, special spin, 0.8mm	
97211030	Nozzle, special spin, 1.0mm	
97212510	Nozzle, special spin, 1.5mm	
97212397	Nozzle, special spin, 2.0mm	

## 10.7 Article Numbers for Nozzle Needles

7.0.0	<b>Nozzle needle complete, Standard, Marking, Special spin (Ø 3x72.5mm)</b>	
Article-No.	Description	
97112508	Nozzle needle, Standard, 0.2/0.3mm	
97110471	Nozzle needle, Standard, 0.5mm	
97111251	Nozzle needle, Standard, 0.8mm	
97111079	Nozzle needle, Standard, 1.0mm	
97112506	Nozzle needle, Standard, 1.2mm	
97112388	Nozzle needle, Standard, 1.5mm	
97111069	Nozzle needle, Standard, 1.8/2.0mm	
97111171	Nozzle needle, Standard, 2.5mm	

7.0.0	<b>Nozzle needle complete, KLS, (Ø 3x72.5mm)</b>	
Article-No.	Description	
97110187	Nozzle needle, KLS, 0.2/0.3mm	
97110188	Nozzle needle, KLS, 0.5mm	
97110189	Nozzle needle, KLS, 0.8/1.0mm	
97110190	Nozzle needle, KLS, 1.2mm	
97110191	Nozzle needle, KLS, 1.5mm	
97110192	Nozzle needle, KLS, 2.0mm	
97111301	Nozzle needle, KLS, 2.5mm	

7.0.0	<b>Nozzle needle complete, KLS/K (hardened by Kolsterising), (Ø 3x72.5mm)</b>	
Article-No.	Description	
97112532	Nozzle needle, KLS/K, 0.2/0.3mm	
97112505	Nozzle needle, KLS/K, 0.5mm	
97111899	Nozzle needle, KLS/K, 0.8/1.0mm	
97113953	Nozzle needle, KLS/K, 1.2mm	
97112886	Nozzle needle, KLS/K, 1.5mm	
97112217	Nozzle needle, KLS/K, 2.0mm	

<b>7.0.0</b>	<b>Nozzle needle complete, Raster-needle query, Standard, Marking, Special spin (Ø3x77.5mm)</b>	
<b>Article-No.</b>	<b>Description</b>	
97111795	Nozzle needle, Standard, 0.2/0.3mm	
97111330	Nozzle needle, Standard, 0.5mm	
97112037	Nozzle needle, Standard, 0.8mm	
97111338	Nozzle needle, Standard, 1.0mm	
97113030	Nozzle needle, Standard, 1.2mm	
97111999	Nozzle needle, Standard, 1.5mm	
97111854	Nozzle needle, Standard, 2.0mm	
97112930	Nozzle needle, Standard, 2.5mm	

<b>7.0.0</b>	<b>Nozzle needle complete, Raster-needle query, KLS, (Ø3x77.5mm)</b>	
<b>Article-No.</b>	<b>Description</b>	
97111431	Nozzle needle, KLS, 0.2/0.3mm	
97111430	Nozzle needle, KLS, 0.5mm	
97111243	Nozzle needle, KLS, 0.8/1.0mm	
97111432	Nozzle needle, KLS, 1.2mm	
97111433	Nozzle needle, KLS, 1.5mm	
97111434	Nozzle needle, KLS, 2.0mm	
97112931	Nozzle needle, KLS, 2.5mm	

## 10.8 Article Numbers for Valves

<b>11.0.0</b>	<b>Air Control Valve</b>	
<b>Article-No.</b>	<b>Description</b>	
97800016	Air control valve for atomizer air pressure > 1,8 bar	
97800132	Air control valve for atomizer air pressure < 1,8 bar	

<b>17.0.0</b>	<b>5/2-way Magnetic Valve</b>	
<b>Article-No.</b>	<b>Description</b>	
97150015	Magnetic valve 24V / DC / 1.8W with plug	
97150023	Magnetic valve 24V / DC / 1.8W with LED plug	
97150017	Magnetic valve 110V / 50Hz / 1.8W with plug	
97150016	Magnetic valve 220V / 50Hz / 1.5W with plug	
97640110	Seal Buna for 5/2-way solenoid valve	

## 10.9 Article Numbers for Threaded Joints

<b>21.0.0</b>		<b>Threaded joint for connection „Control air SL“</b>	
<b>Article-No.</b>	<b>Description</b>		
QSM-M5-4-I	Threaded joint M5 (for hose 4mm)		
QSM-M5-6-I	Threaded joint M5 (for hose 6mm)		
97220089	Threaded joint complete (SW 8x19mm)		

<b>21.1.0</b>		<b>Threaded joint for connection „Atomizer air ZL“</b>	
<b>Article-No.</b>	<b>Description</b>		
QSM-1/8-4-I	Threaded joint G1/8 (for hose 4mm)		
QSM-1/8-6-I	Threaded joint G1/8 (for hose 6mm)		
QSM-1/8-8-I	Threaded joint G1/8 (for hose 8mm)		
97220022	Threaded joint (SW 13x28mm)		

<b>21.2.0</b>		<b>Threaded joint for connection „Material M“</b>	
<b>Article-No.</b>	<b>Description</b>		
975165100656	Threaded joint G1/8 (for hose 6mm)		
11.118-6	Threaded joint G1/8 (for hose 6mm)		
11.118-8	Threaded joint G1/8 (for hose 8mm)		
97220022	Threaded joint (SW 13x28mm)		
RV08GE1/8-LR/KÖ/ED	Threaded joint G1/8 (for hose NW6)		
RV10GE1/8-LR/KÖ/ED	Threaded joint G1/8 (for hose NW8)		
RV12GE1/8-LR/KÖ/ED	Threaded joint G1/8 (for hose NW10)		

## 10.10 Article Numbers for Other Parts

<b>Article-No.</b>	<b>Description</b>	
97150131	Plug with LED	
97820168	Stronger pressure spring Raster-needle query	

## 10.11 Wear-and-Tear Parts

### **Material wear-and-tear set complete for SMS-02 (Standard and Needle query)<sup>1</sup>**

#### **Consisting of:**

- # Pos. 5.1.0 (Variseal)
- # Pos. 5.3.0 (O-ring)
- # Pos. 5.4.0 (protection sleeve)
- # Pos. 6.2.0 (O-ring)

Article-No.	Description
979504.000	Material wear-and-tear set for SMS-02 (Standard), VITON
979504.001	Material wear-and-tear set for SMS-02 (Standard), EPDM
979504.002	Material wear-and-tear set for SMS-02 (Standard), ISOLAST

<sup>1</sup> This material wear-and-tear set is recommended when nozzle needle and nozzle are replaced.

### **Wear-and-tear set complete for SMS-02 (Standard)<sup>2</sup>**

#### **Consisting of:**

- # Pos. 5.0.0 (Material sealing set complete)
- # Pos. 6.2.0 (O-ring)
- # Pos. 7.4.0 (O-ring)
- # Pos. 7.5.0 (O-ring)
- # Pos. 9.6.3 (pressure spring)
- # Pos. 9.7.3 (O-ring)
- # Pos. 9.9.3 (O-ring)
- # Pos. 10.0.0 (return check valve complete)
- # Pos. 11.0.0 (air control valve complete)

Article-No.	Description
979504.003	Wear-and-tear kit for SMS-02 (Standard), VITON
979504.004	Wear-and-tear kit for SMS-02 (Standard), EPDM
979504.005	Wear-and-tear kit for SMS-02 (Standard), ISOLAST

### **Wear-and-tear set complete for SMS-02 (Raster-needle query)<sup>2</sup>**

#### **Consisting of:**

- # Pos. 5.0.0 (Material sealing set complete)
- # Pos. 6.2.0 (O-ring)
- # Pos. 7.4.0 (O-ring)
- # Pos. 8.0.0 (pressure spring)
- # Pos. 10.0.0 (return check valve complete)
- # Pos. 11.0.0 (air control valve complete)

Article-No.	Description
979504.006	Wear-and-tear kit for SMS-02 (Raster-needle query), VITON
979504.007	Wear-and-tear kit for SMS-02 (Raster-needle query), EPDM
979504.008	Wear-and-tear kit for SMS-02 (Raster-needle query), ISOLAST

<sup>2</sup> This wear-and-tear kit is recommended for a complete overhaul of the device.

## 10.12 Accessories

Figure	Article Number	Description
	97xxxxxx	Nozzle Extension (see also Product Catalog ACCESSORIES)
	97410042	Retainer ring hexagonal
	97410059	Retainer ring stainless steel
	979565.001	Hot Plate (see also Product Catalog ACCESSORIES)
	97PA21G-XX	Pressure Sensor (see also Product Catalog „Checking/Prüfen“)
	97947xxx	Counter
	97800037	Pneumatic Needle-Stroke Adjustment
	979444	Cleaning set (see also Product catalog ACCESSORIES)

Figure	Article Number	Description
	97320602	Centering sleeve for an exact positioning of the valve

### 10.12.1 Center hole for Centering sleeve 97320602

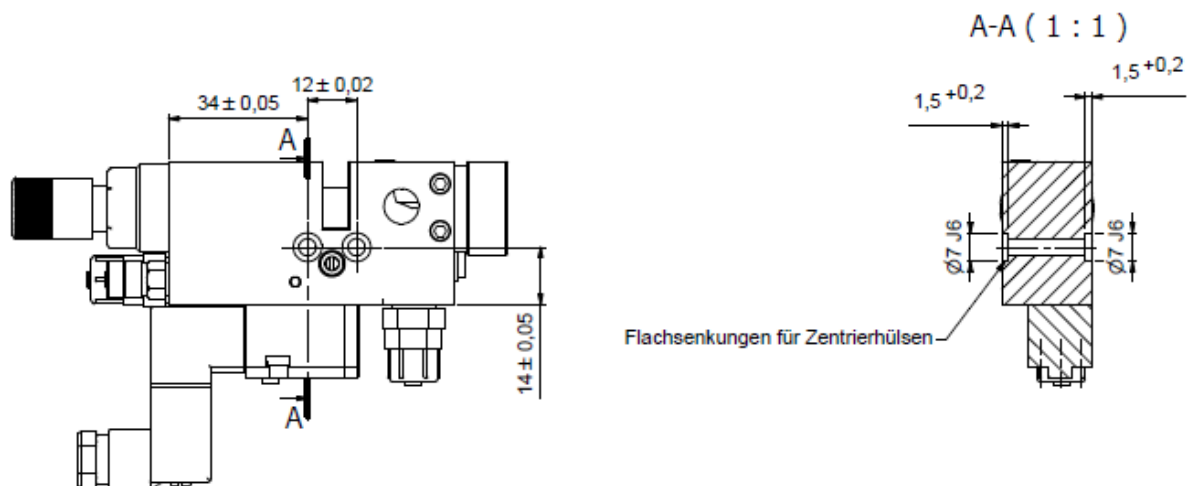

#### WICHTIG

If a Centering sleeve is retrofitted to an existing valve, the valve must be returned to us for retrofitting of Center hole.



## 10.12.2 Add-on Elements

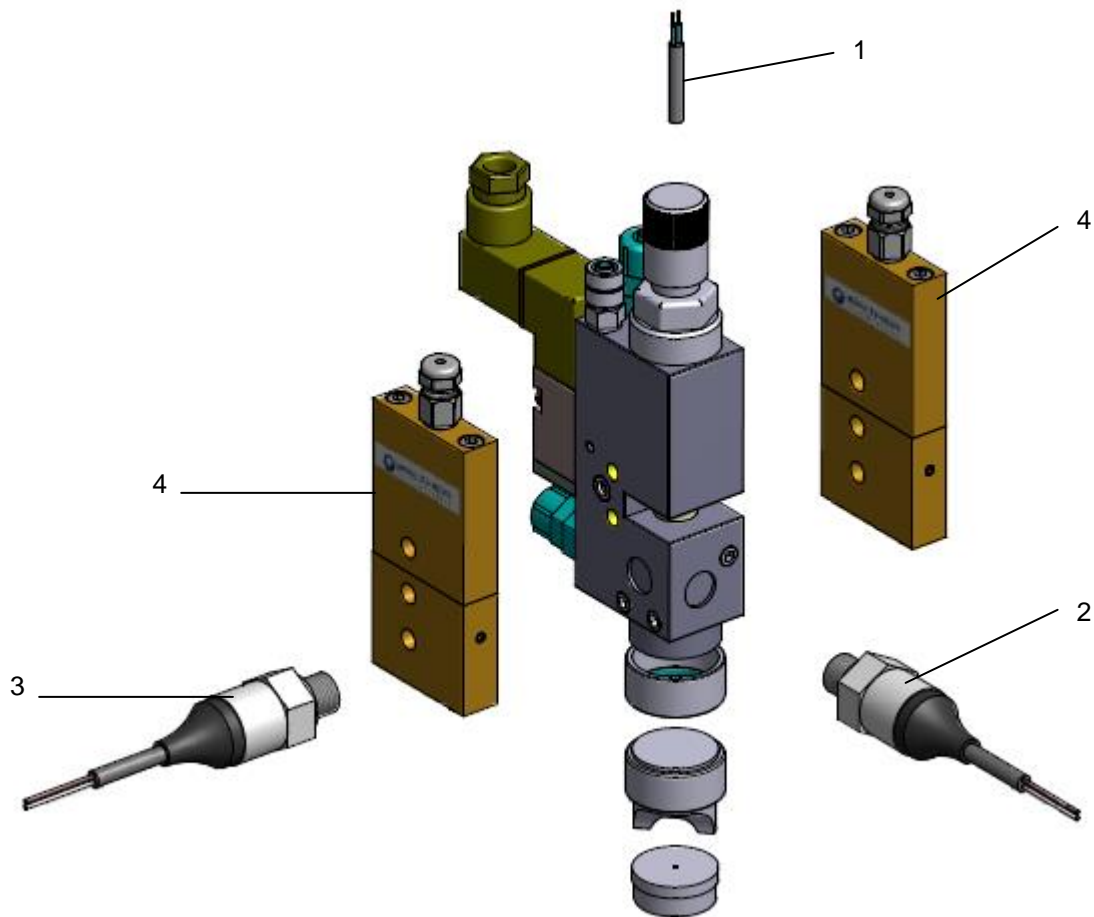

### Needle Detection

The mounting of the needle selection will be made factory-side. It will be integrated in the raster needle lock (Pos. 9.0 Spare Part List). If ordered as spare part, please note that a complete raster needle lock will be delivered as the initiator has to be set at the factory and also glued in.

Pos.	Description
1	Raster needle detection

### Pressure Sensor

The installation of the pressure sensor will be made factory-side. Its actual position can be either at the side right or on top. Please refer to the assembly instructions „Pressure Sensors 97PA-21x-xxx“ for additional information.

Pos.	Description
2	Pressure sensor mounted on top of the spray valve
3	Pressure sensor mounted at the right side of the spray valve

### Heating Plate

The heating plate (4) will be mounted factory-side. Its actual position will be at the side (left / right). Please see the description „Heating and Accessories“ for additional information.

### 10.12.3 Description Pneumatic Needle-Stroke Adjustment 97800037

#### Description of Function

The pneumatic Needle Stroke Adjustment (PNA) is used for a remote-controlled change between two needle-stroke settings.

The front regulating screw (1; see pic.) determines the minimum needle stroke of the spraying device for a PNA with applied pressure. The back regulating screw (2; see pic.) determines the additional (maximum) needle stroke for a PNA without applied pressure.

#### Setting

For a pre-setting, the front regulating screw (1; see pic.) will be turned back (left turn) until no more raster steps are possible. After that the back regulating screw (2; see pic.) will be turned to the front until stop (right turn). Strictly follow this procedure to ensure a correct setting of both needle positions.

The spray application has to be activated/released in order to adjust both needle positions. The discharged medium will be set to the desired minimum quantity (low needle stroke) through the front regulating screw (1; see pic.). Then the desired maximum quantity (large stroke) will be set by turning back (left turn) of the back regulating screw.

#### Important!

The PNA has to permit an opening of the needle in both positions (large and small stroke). In no case will it be used to close the needle.

This is exclusively performed by the controls of the spray valve!

When a pressure of 6 bar will be applied to the PNA at the hose nipple (3; see pic.), the small needle stroke has been set; the large stroke is set without pressure.

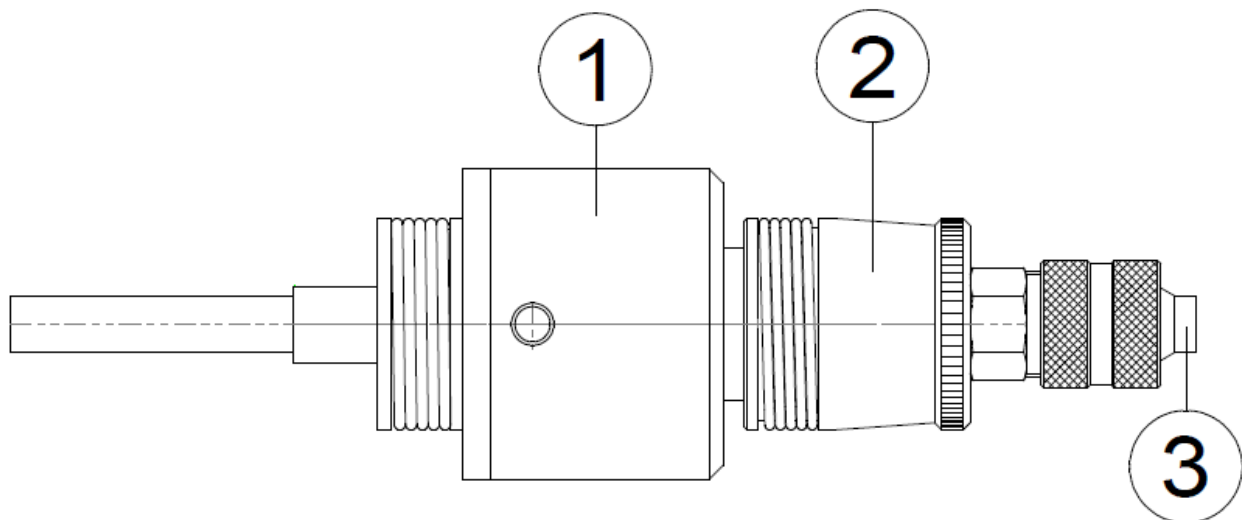

#### Operation

You can switch between the stroke settings during operation via the hose nipple (3):

- Air pressure = 6 bar
- With applied air = low stroke
- With air turned off = large stroke

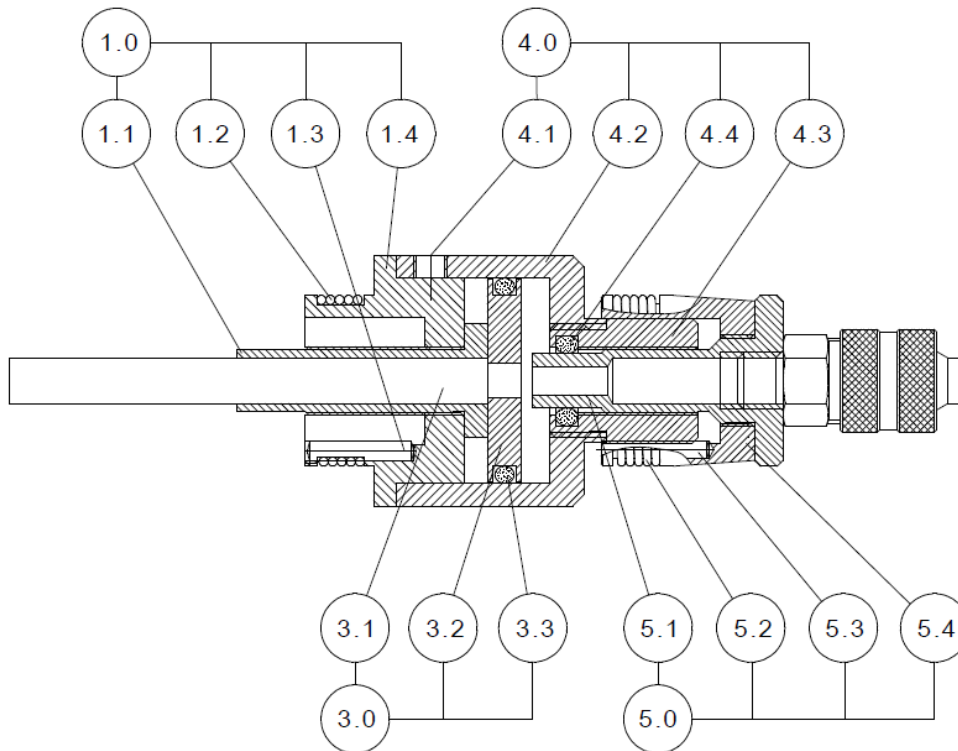

Pos.	Article No.	Qty	Description
1.0	97610172	1	Raster head
1.1	97610170	1	Regulating hollow spindle
1.2	97820000	1	Pressure spring
1.3	97320022	1	Cylinder pin DIN 6325
1.4	97320196	1	Regulating button
3.0	97710021	1	Piston complete
3.1	97320145	1	Piston rod
3.2	97710020	1	Piston
3.3	97640007	1	O-Ring Viton®
4.0	97320198	1	Air cylinder, complete
4.1	97610031	3	Threaded pin DIN 914
4.2	97320193	1	Air cylinder with knurl
4.3	97320144	1	Raster hollow screw
4.4	97640027	1	O-Ring Viton®
5.0	97610173	1	Raster head
5.1	97610171	1	Regulating hollow spindle
5.2	97820000	1	Pressure spring
5.3	97320022	1	Cylinder pin DIN 6325
5.4	97320197	1	Regulating button